

GRADE 3
English
Home Language

Term /

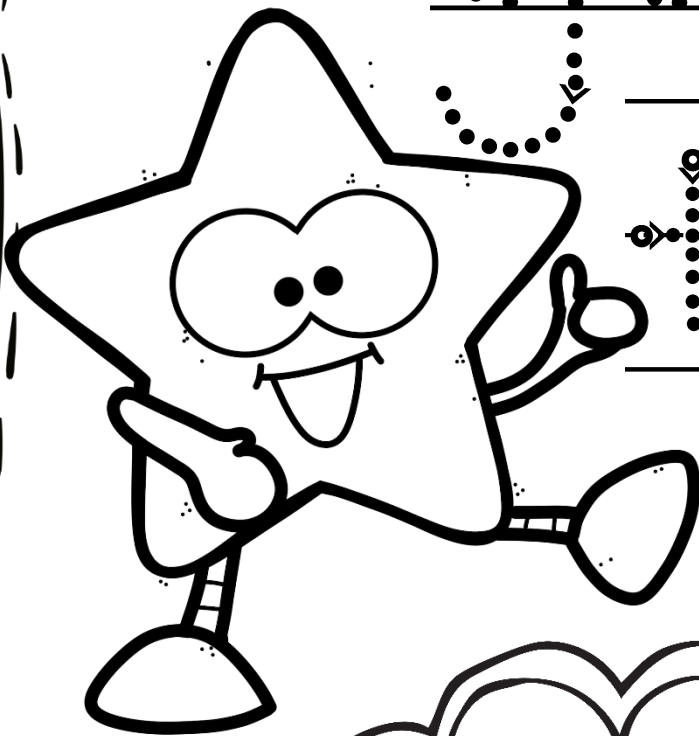

Name:

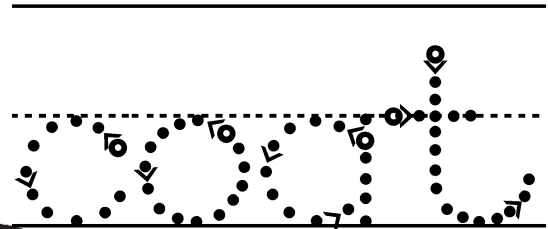
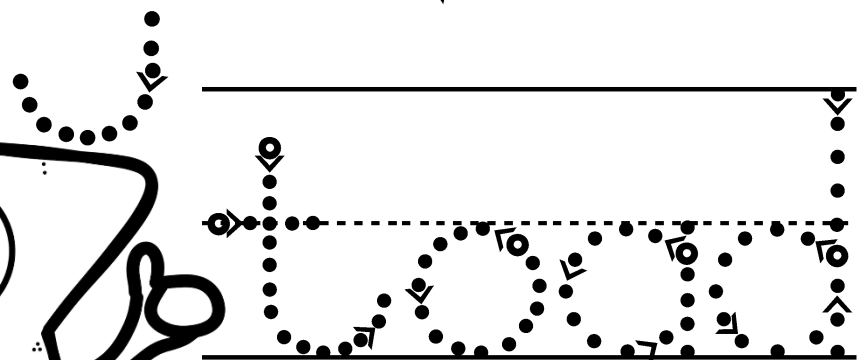
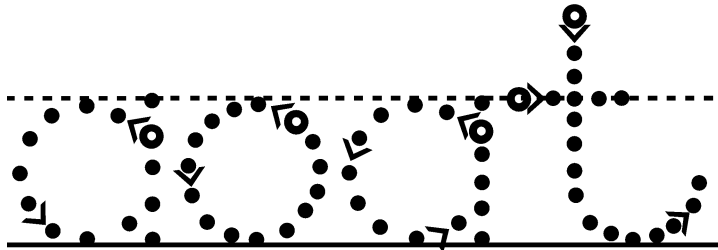
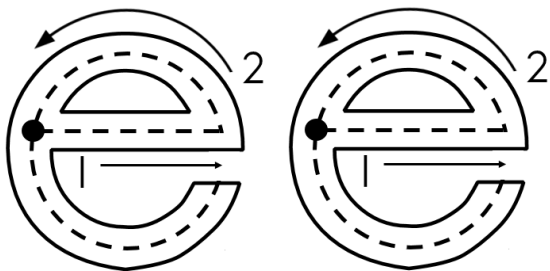

Practice writing the sound

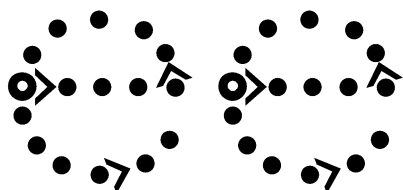

Fill the ee sound into the blocks.

--	--

Complete the words.

gr ____ n sh ____ p
wh ____ l sl ____ p
f ____ t tr ____
gr ____ t st ____ p

Write your own ee words.

Write a sentence with the ee sound and underline the word with a colour pencil.

ee sound

Read the words and underline the sound.

wheel	sheep	steep	bee
teeth	feet	greet	tree
sleep	cheese	green	knee

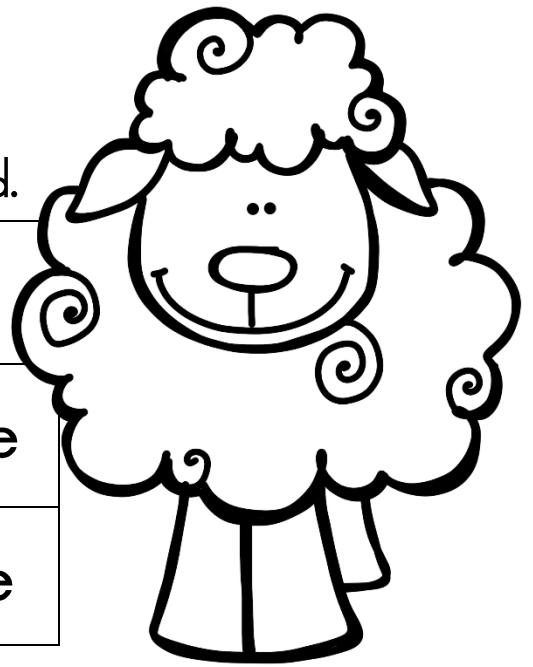

Underline the ee word in each sentence.

1. I greet my teacher.
2. The leaves of the tree are green.
3. I chew the cheese with my teeth.
4. The hill is steep.
5. A sheep gives us wool.

Write the word for each picture.

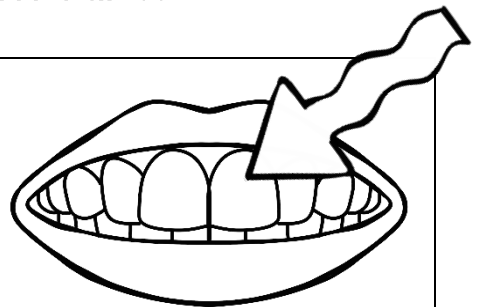
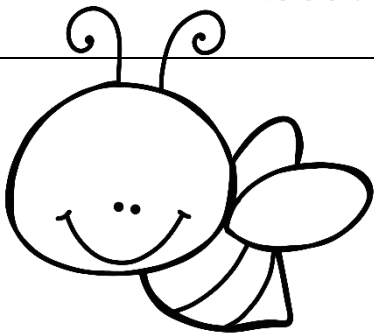

--	--	--

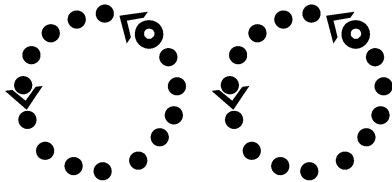
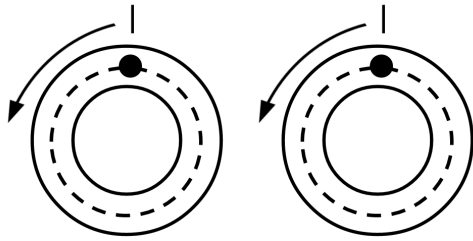

Practice writing the sound

Fill the oo sound into the blocks.

--	--

Complete the words.

r____ f sch ____ l
m____ n f ____ l
f ____ t c ____ l
w ____ l h ____ k

Write your own oo words.

Write a sentence with the oo sound and underline the word with a colour pencil.

oo sound

Read the words and underline the sound.

school	fool	cool	roof
foot	wool	wood	cook
hook	book	moon	food



Underline the oo word in each sentence.

1. I read a book at school.
2. Our house has a roof.
3. The wind is cool.
4. The moon shines at night.
5. My mother is cooking food.

Write the word for each picture.

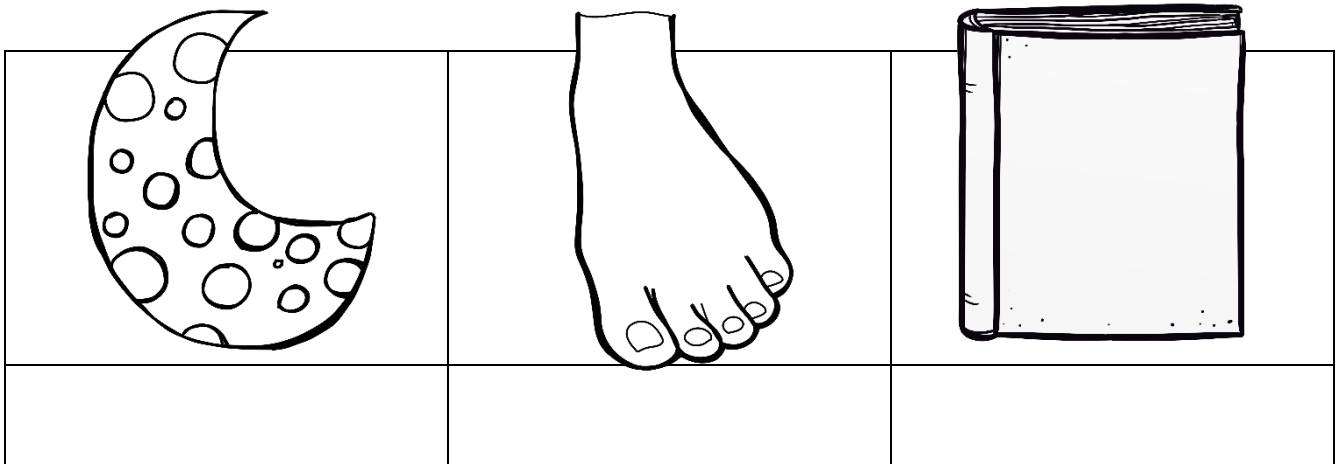

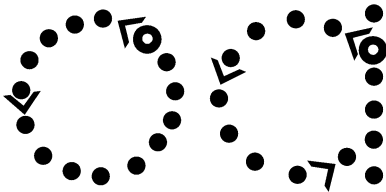
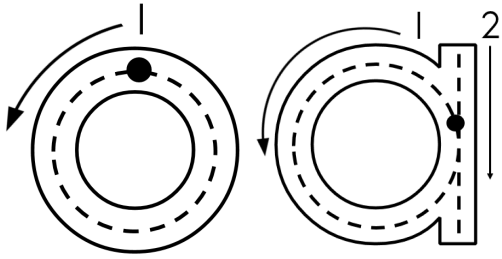

Practice writing the sound

Fill the oa sound into the blocks.

--	--

Complete the words.

r ____ d s ____ p
g ____ t b ____ t
c ____ l ____ ts
c ____ t r ____ d

Write your own oa words.

Write a sentence with the oa sound and underline the word with a colour pencil.

oa sound

Read the words and underline the sound.

goat	coat	coal	float
toad	oats	road	throat
soap	boat	coat	toast

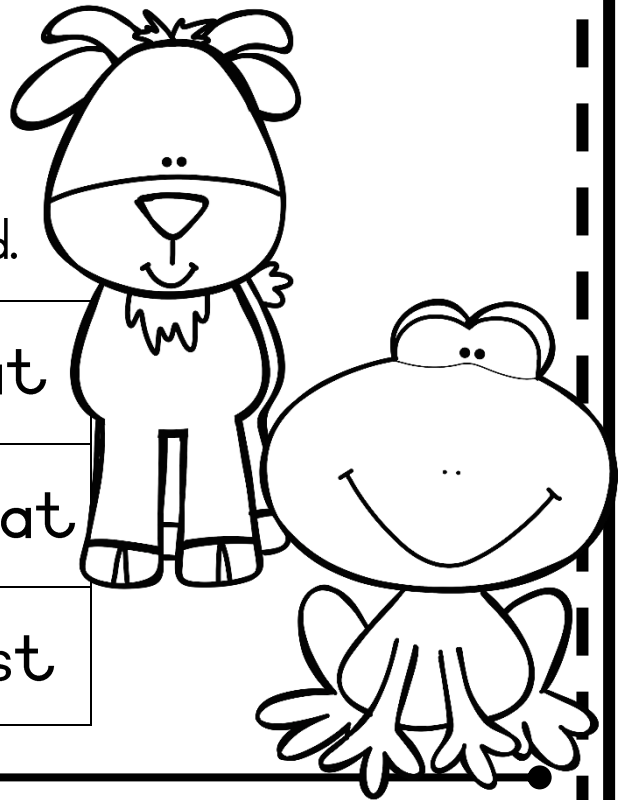

Underline the oa word in each sentence.

1. The car is driving on the road.
2. My throat is sore.
3. There is a toad in the pond.
4. The boat is sailing on the ocean.
5. The boy is eating oats.

Write the word for each picture.

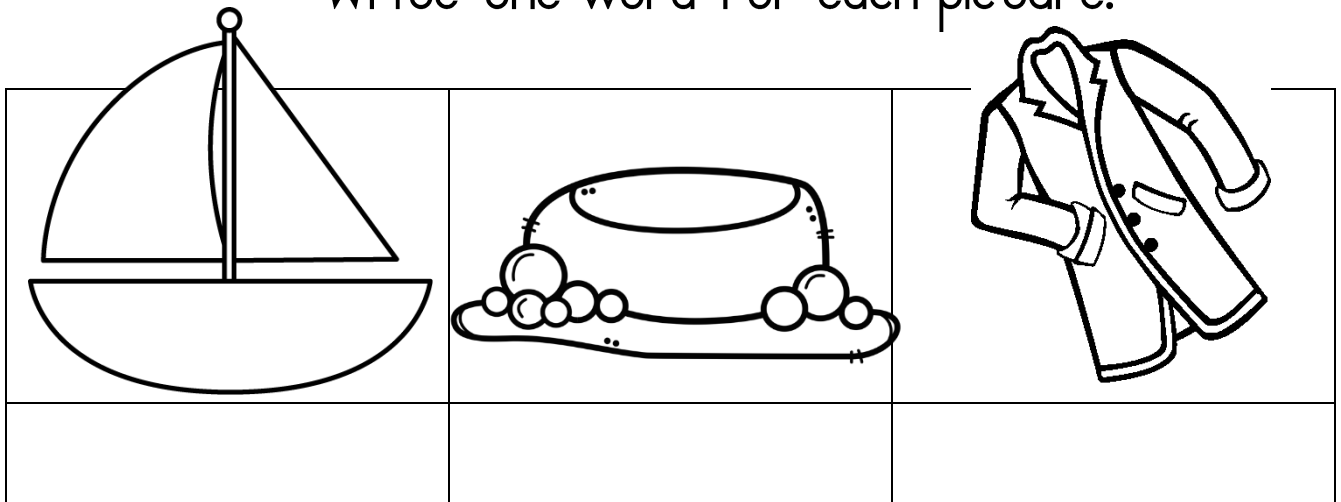

Colour the sound.

1 - yellow

2 - green

- Read the words.
- Underline the or sound.

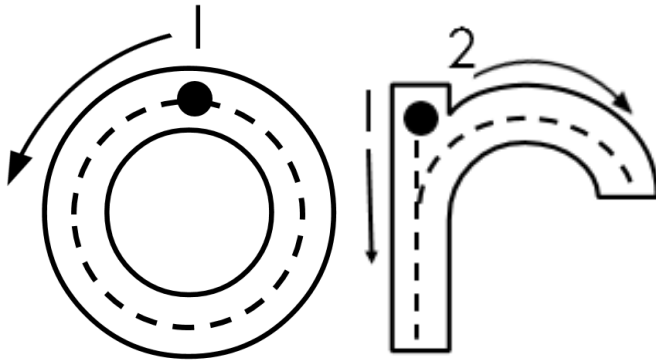
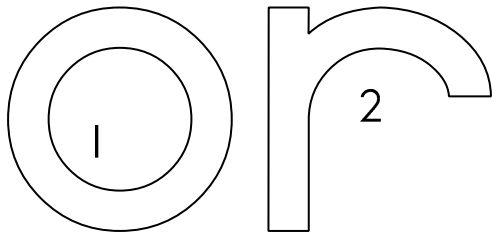

torn	shorts
sports	word
work	fork
horn	torch

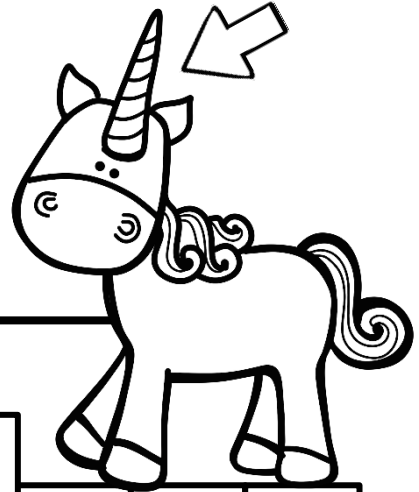

Build the words.

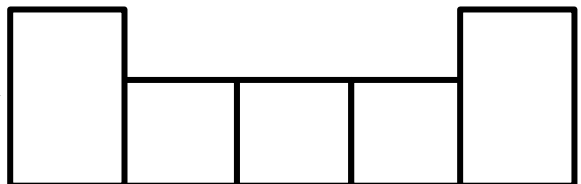
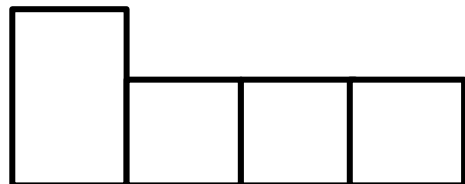
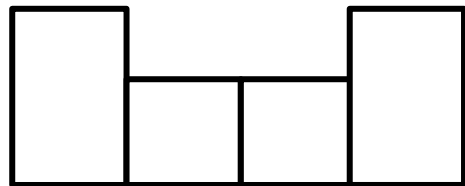
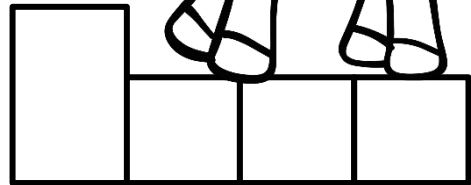
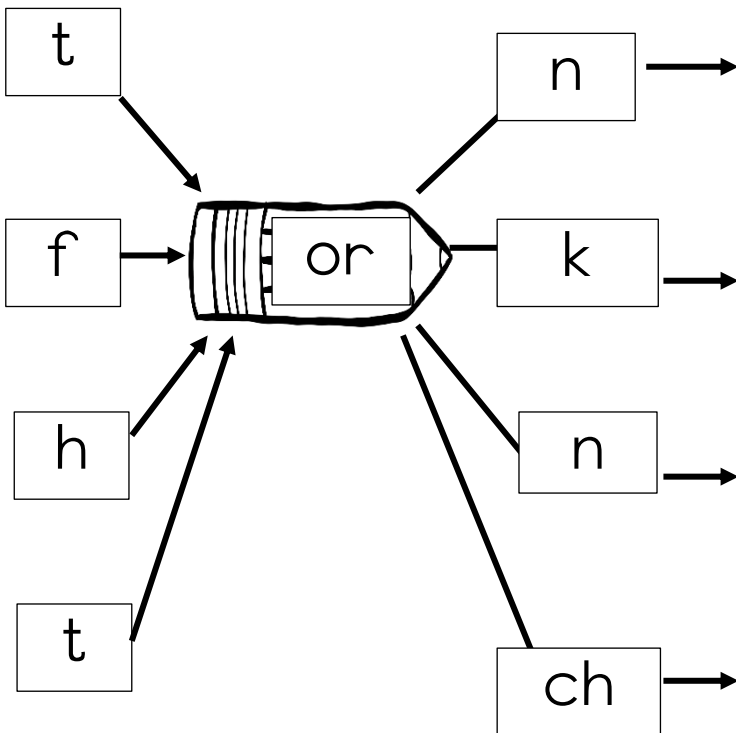

Colour the sound.

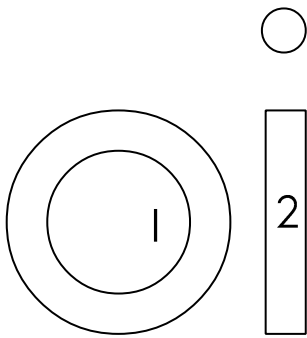

1 - blue

2 - green

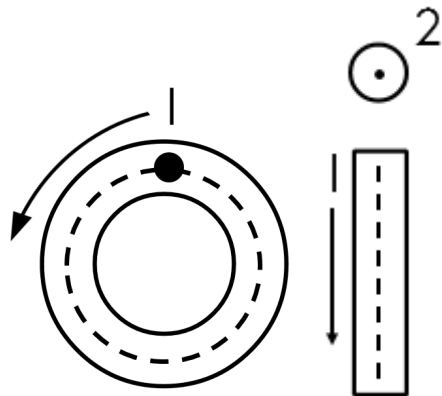

- Read the words.
- Underline the oi sound.

oil	boil
soil	coin
foil	voice
oink	point

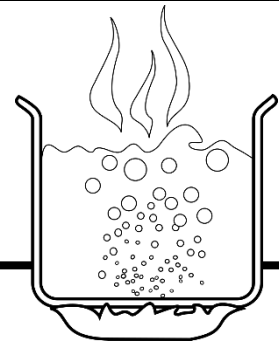

Build the words.

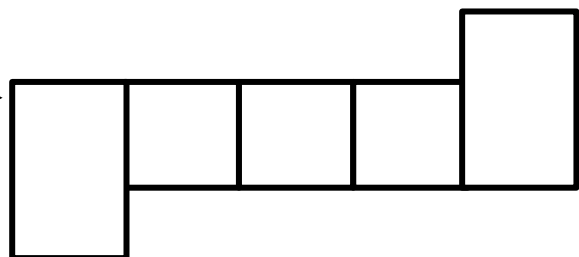
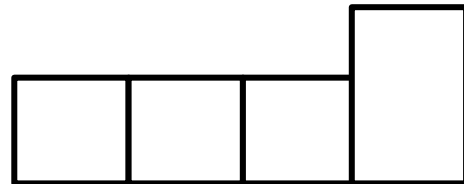
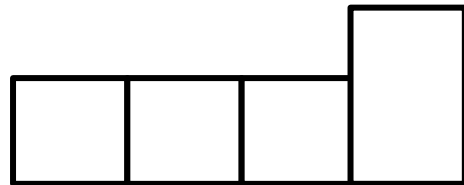
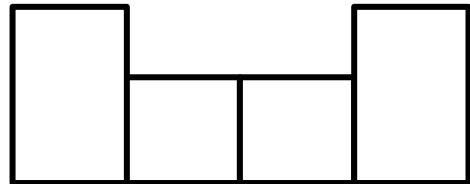
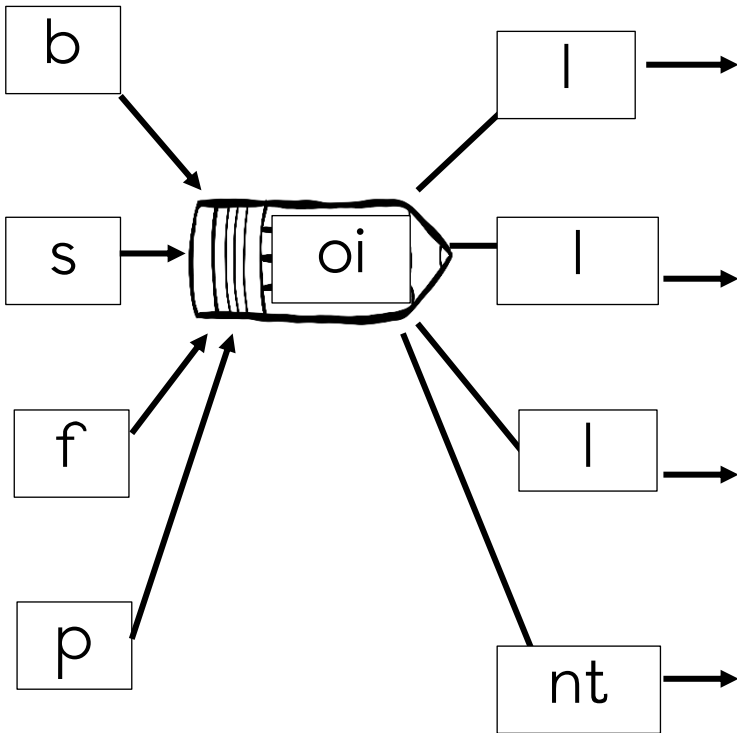

Colour the sound.

1 - blue

2 - red

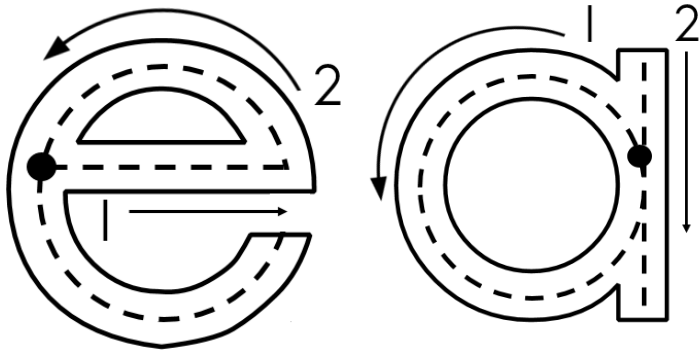
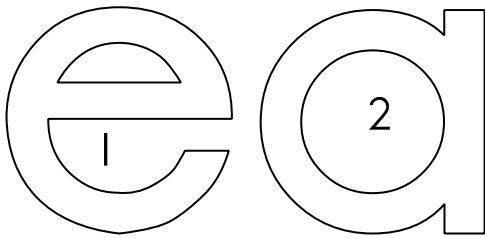

- Read the words.
- Underline the ea sound.

neat	clean
mean	meat
beach	seat
eat	stream
heat	lean
seal	teacher

Build the words.

n

cl

m

s

ea

t

n

t

l

Colour the sound.

1 - grey

2 - red

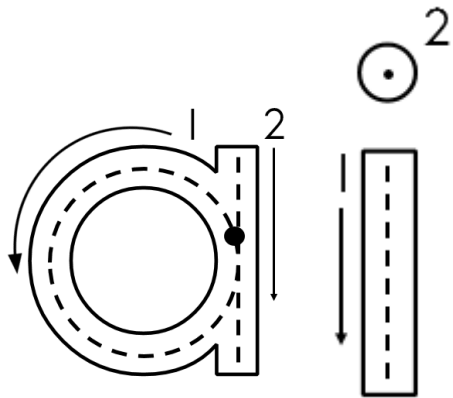
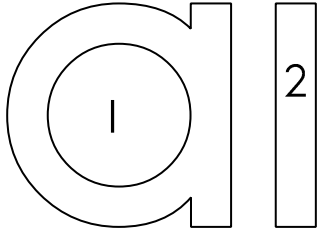

- Read the words.
- Underline the ai sound.

rain	wait
again	pain
pair	train
tail	mail
nail	hail

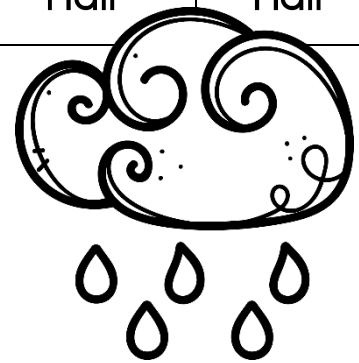

Build the words.

r → [] [] [] []

ag → [] [] [] [] []

w → [] [] [] []

p → [] [] [] []

n → [] [] [] []

n → [] [] [] []

t → [] [] [] []

n → [] [] [] []

Colour the sound.

1 - pink

2 - purple

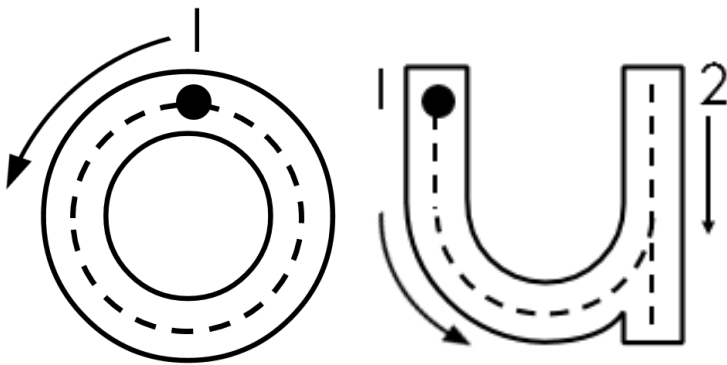
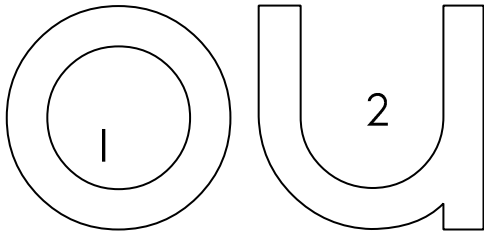

- Read the words.
- Underline the ou sound.

out	shout
our	about
loud	mouth
found	house
mouse	hour

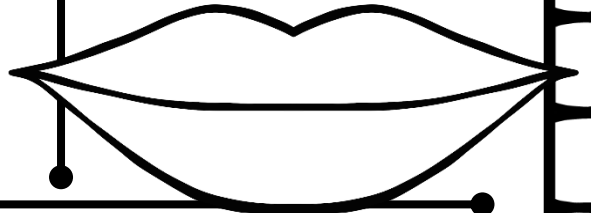

Build the words.

sh

ab

l

h

ou

t

t

d

se

Colour the "sh" sound.

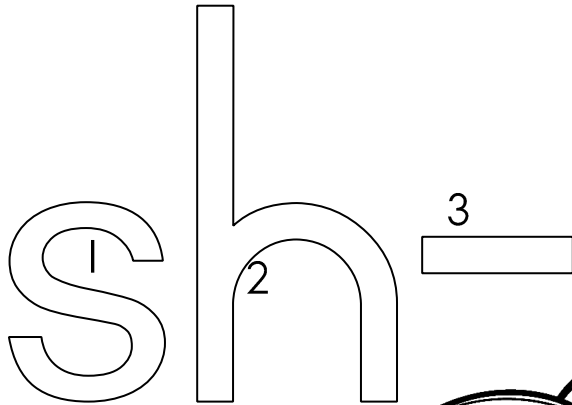

1 - yellow

2 - purple

3 - pink

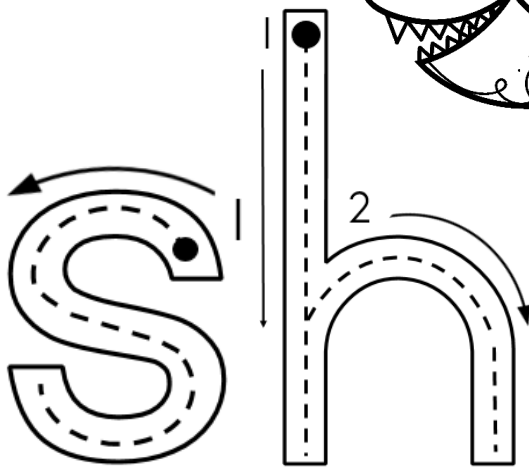
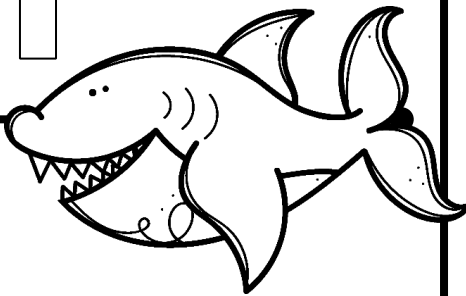

- Read the words.
- Underline the sh- sound

shoe	shop
shark	shy
sharp	ship
sheep	shrimp
shell	she
shout	show
shock	shake
shelf	short

Write the words for each picture.

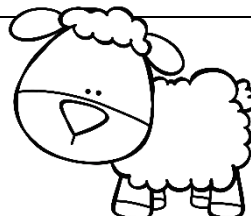
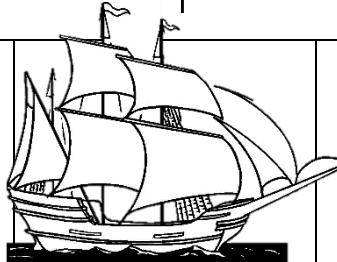
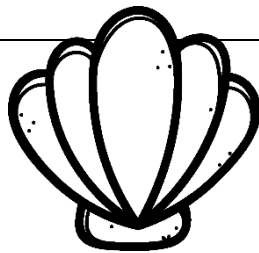
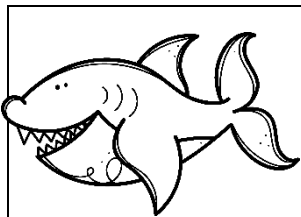

Words ending with -sh

- Read the words.
- Underline the -sh sound

wash

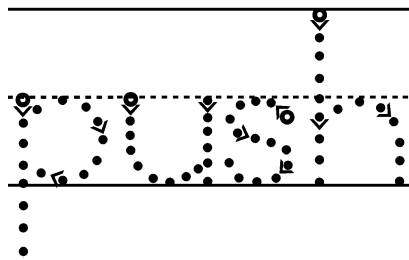
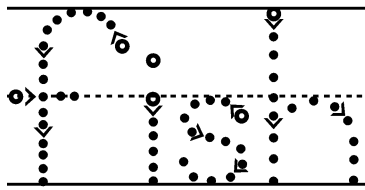
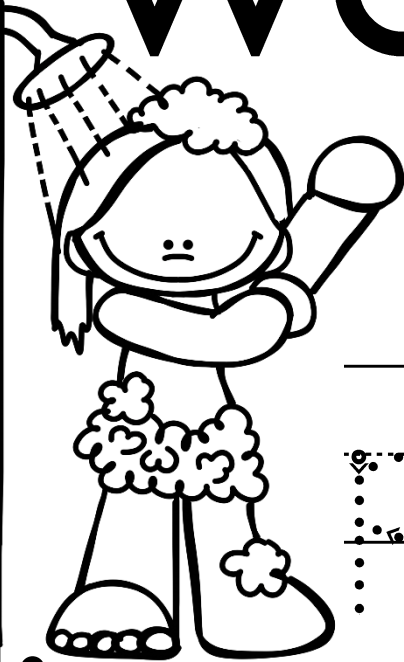

wash	dish
fish	wish
push	rush
bush	crash
flash	dish

Use the words to complete the sentences.

rush	fish	wash	bush	flash	push
------	------	------	------	-------	------

1. My father caught a _____.
2. The camera made a _____ when I took the photo.
3. The mother _____ the baby in the wagon.
4. I _____ the dishes after dinner.
5. We are late for school, now we have to _____ there.

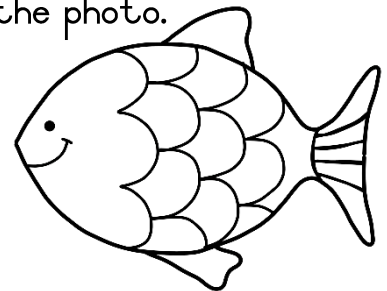

Colour the "ch" sound.

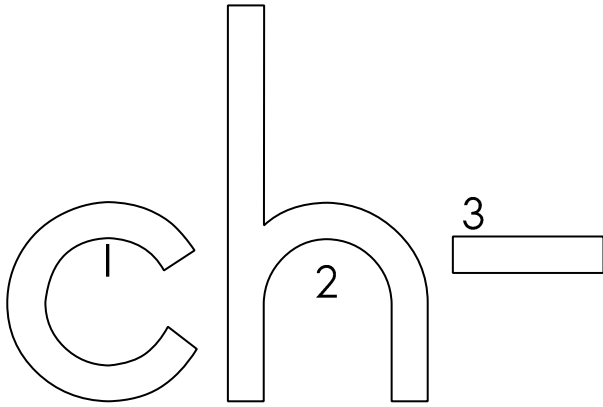

1 - blue

2 - purple

3 - green

- Read the words.
- Underline the ch- sound

chimp	chew
chicks	chair
cheese	chain
chocolate	church
children	chicken
teacher	chin

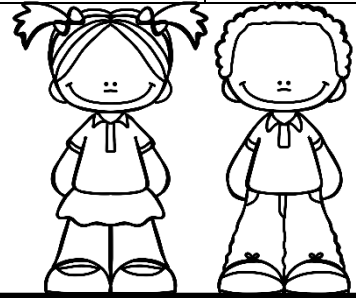
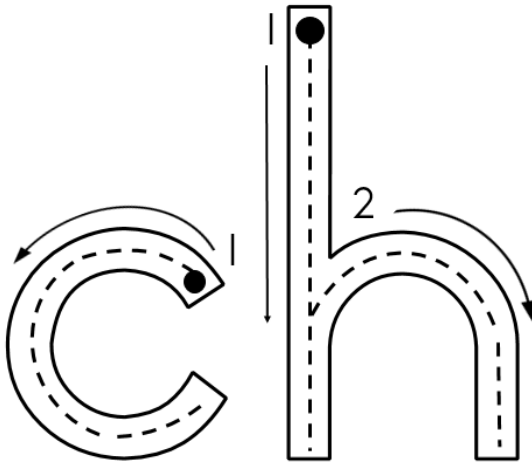

Write the words for each picture.

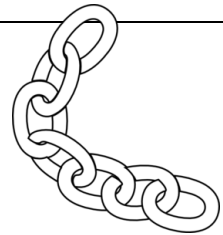
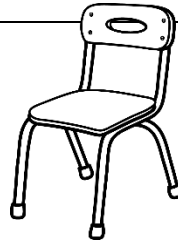
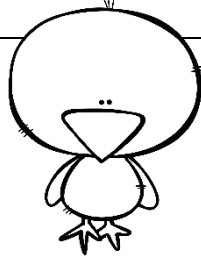
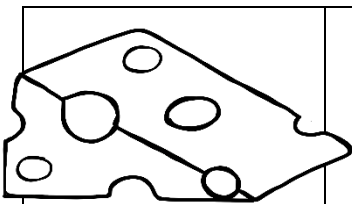

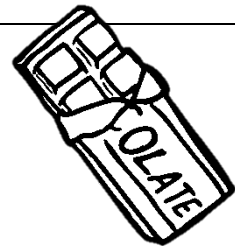
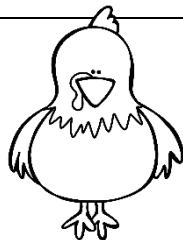
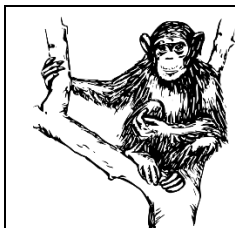

Words ending with -ch

peach

teach

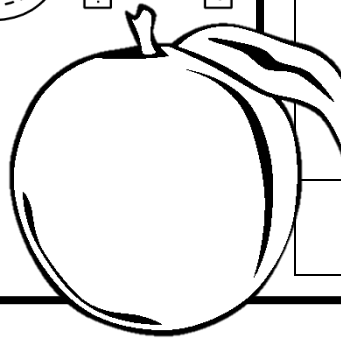

- Read the words.
- Underline the -ch sound

brunch	lunch
munch	such
much	rich
branch	lunch
church	peach
bench	teach
touch	search
crutch	watch
patch	match

Use the words to complete the sentences.

branch	rich	lunch	teaches	church	bench
--------	------	-------	---------	--------	-------

1. The monkey is hanging from the _____.
2. The old man is sitting on the _____.
3. The hungry boy is eating his _____.
4. Our teacher _____ us.
5. On Sunday we go to _____.

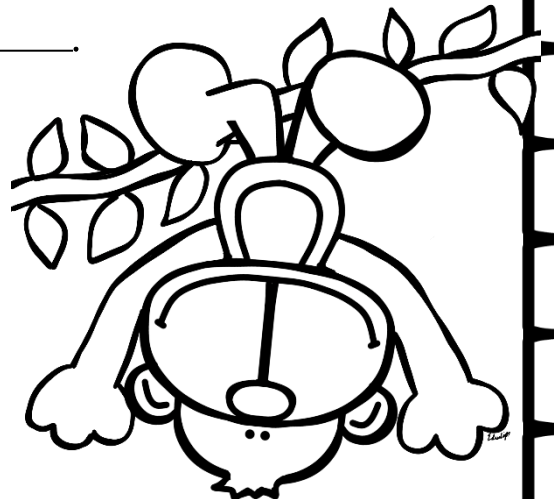

Colour the "wh" sound.

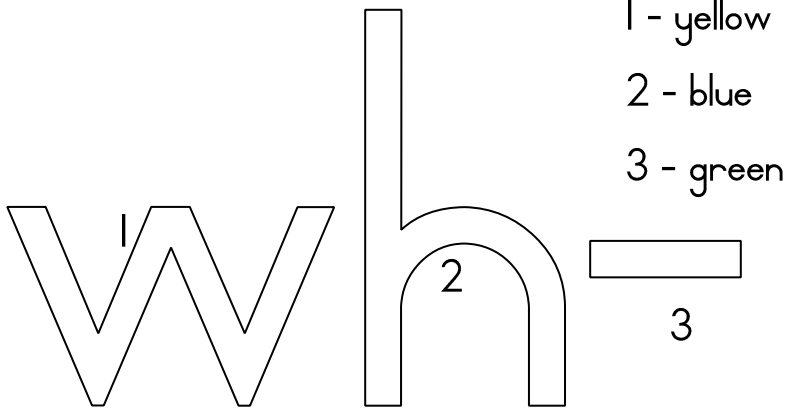

1 - yellow

2 - blue

3 - green

- Read the words.
- Underline the wh- sound

whale	wheel
whirl	white
whether	who
what	when
where	why

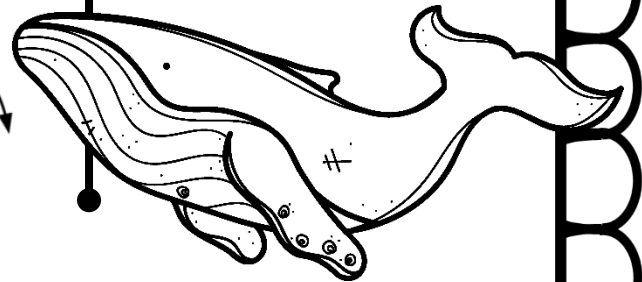
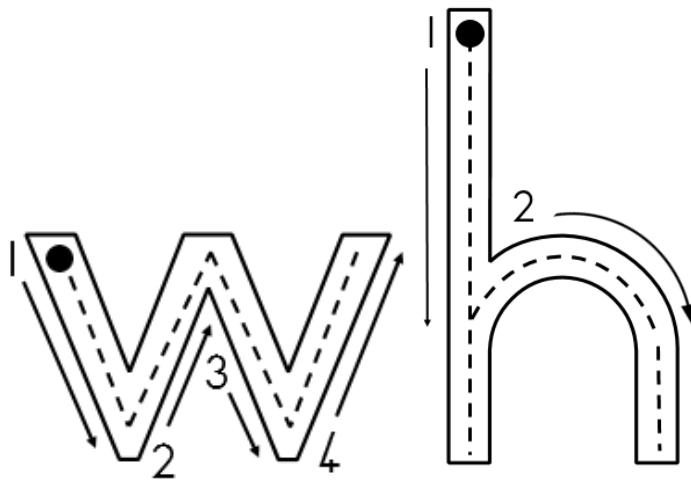

Practice writing the words.

whale		what	
whirl		who	
when		where	
why		white	

Colour the "th" sound.

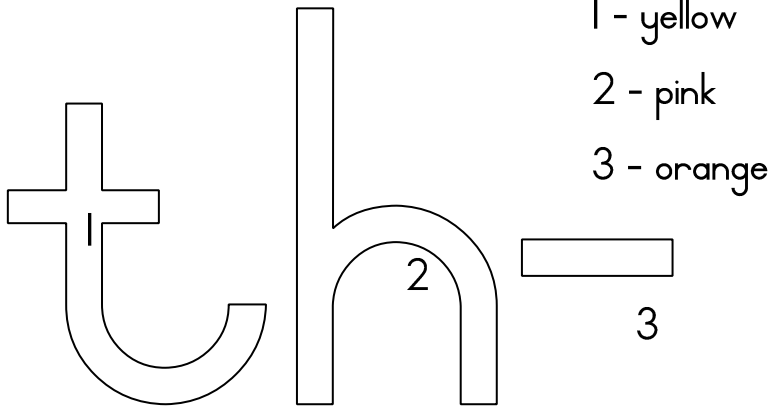

1 - yellow

2 - pink

3 - orange

- Read the words.
- Underline the th- sound

that	there
then	they
this	the
thorn	three
thumb	think

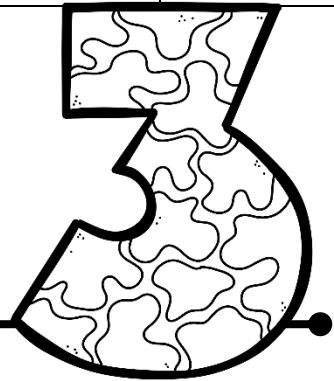
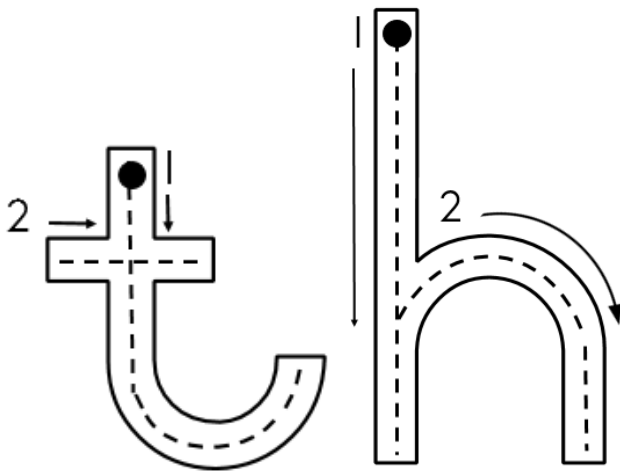

Practice writing the words.

Colour the "-ck" sound.

1 - green

2 - blue

3 - red

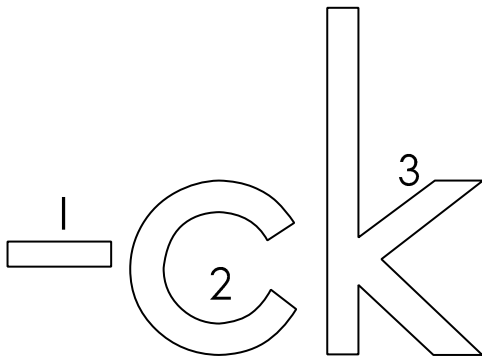

- Read the words.
- Underline the -ck sound

duck	rack
rock	crack
neck	back
sick	lick
kick	brick
lock	clock

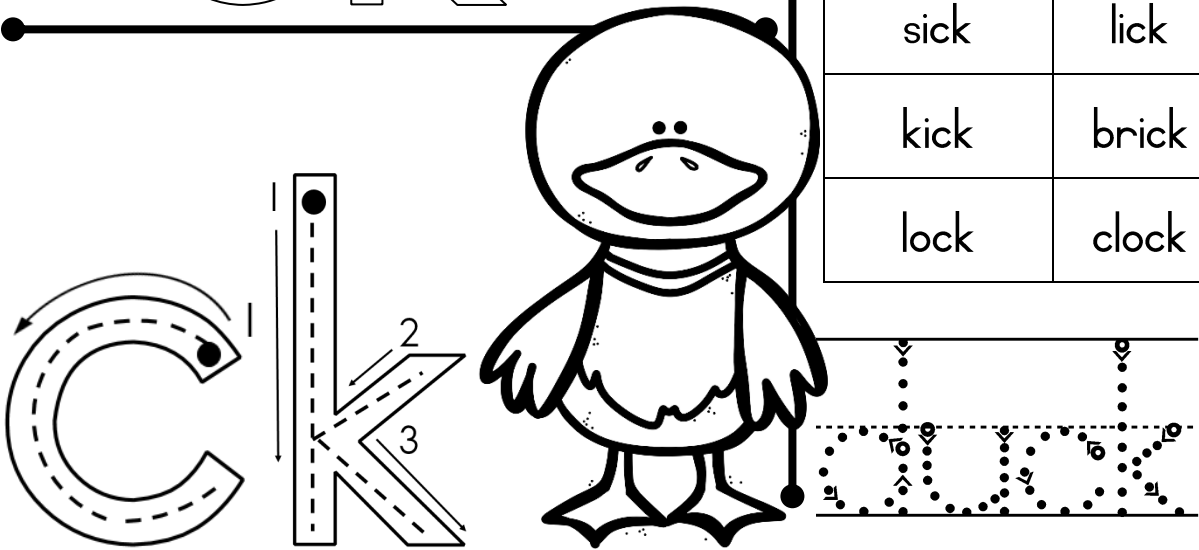

Use the words to complete the sentences.

sick	clock	kicks	bricks	licks
------	-------	-------	--------	-------

6. The boy _____ the ball.
7. The little baby has a fever, he is _____.
8. The girl _____ her ice cream.
9. I look at the time on the _____.
10. The house is build out of _____.



Complete the words by filling in the correct sound.

th-, wh-, ch-, sh-

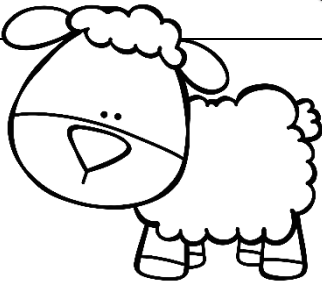

___eep



___ree

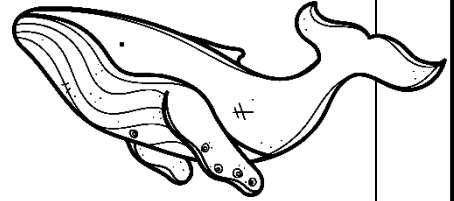

___ale



___oe

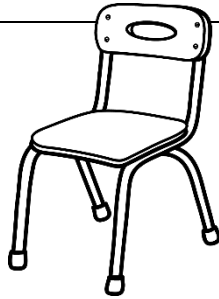

___air

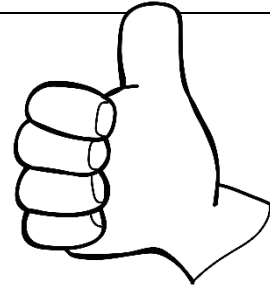

___umb

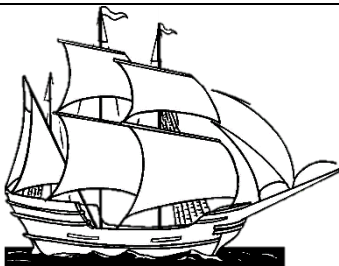

___ip

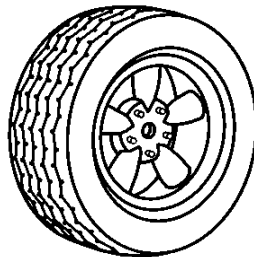

___eel

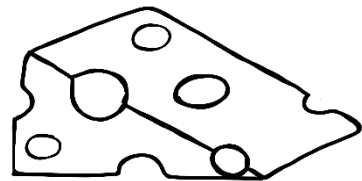

___eese

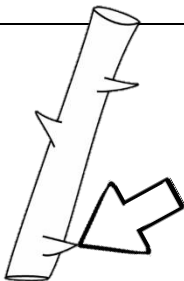

___orn

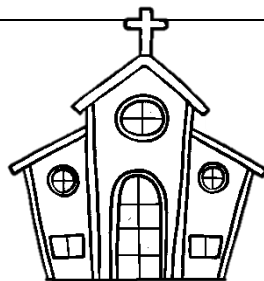

___urch



___irl

Colour the "-ng" sound.

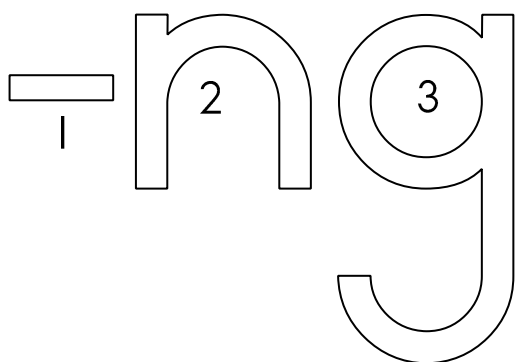

1 - orange

2 - yellow

3 - red

- Read the words.
- Underline the -ng sound

sing	sang
song	ring
king	hang
long	bring
string	wing
long	swing

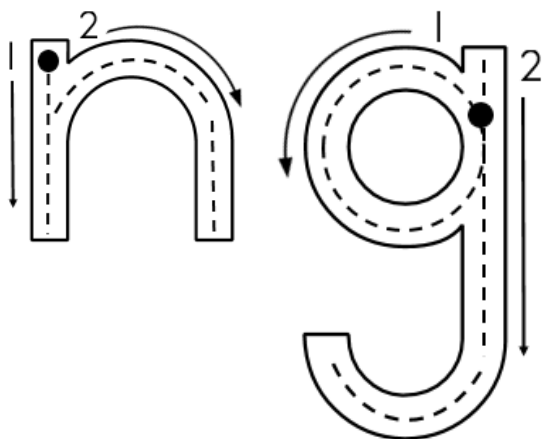

Use the words to complete the sentences.

song	bring	king	long	wings
------	-------	------	------	-------

1. They are the _____ and queen.
2. A bird has _____.
3. The giraffe has a _____ neck.
4. Can you please _____ me a cup of coffee.
5. Anne is singing a _____.

Colour the "ay" sound.

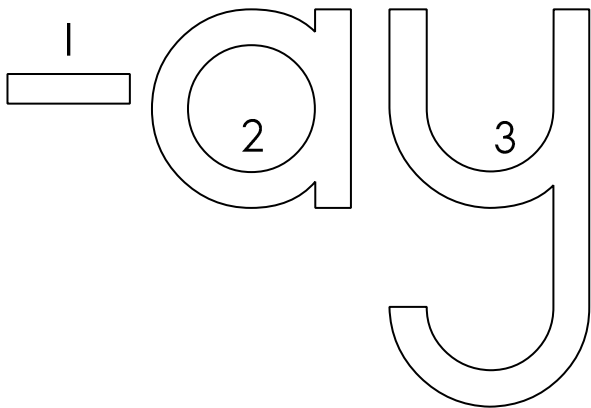

- 1 - yellow
- 2 - purple
- 3 - pink

- Read the words.
- Underline the -ay sound

day	may
play	stay
birthday	bay
hay	clay
say	pray

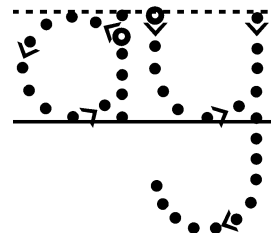
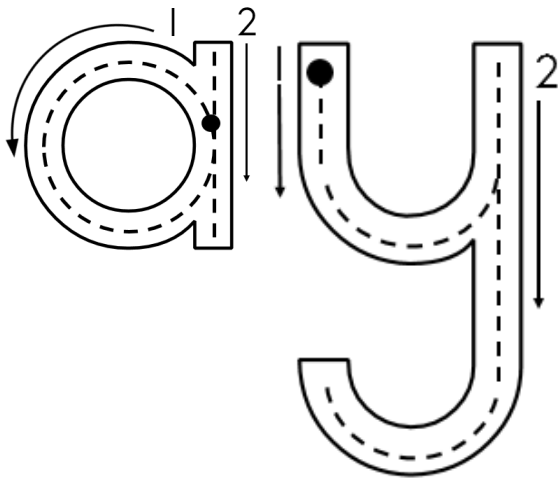

Use the words to complete the sentences.

hay	play	pray	day	birthday
-----	------	------	-----	----------

1. I _____ every night before I go to sleep.
2. The horse is eating _____.
3. During the _____ the sun shines.
4. Can you please _____ with me?
5. Today is my _____.

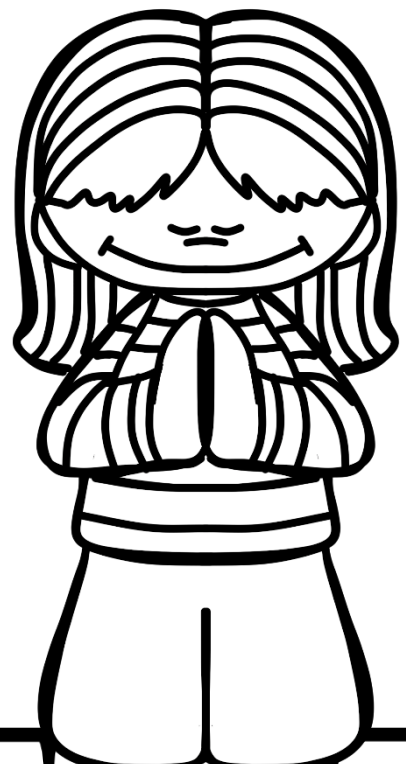

Colour the "ss" sound.

- 1 - yellow
- 2 - orange
- 3 - green

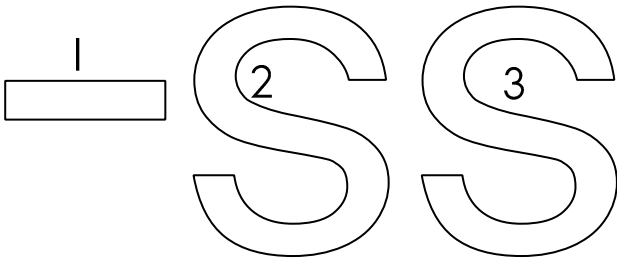

- Read the words.
- Underline the -ss sound

glass	class
pass	press
cross	toss
miss	grass
dress	kiss

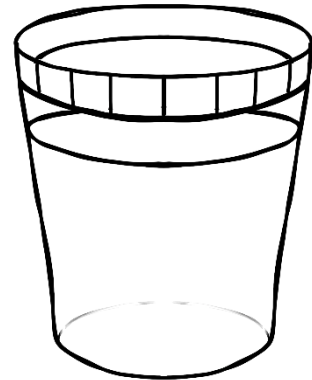
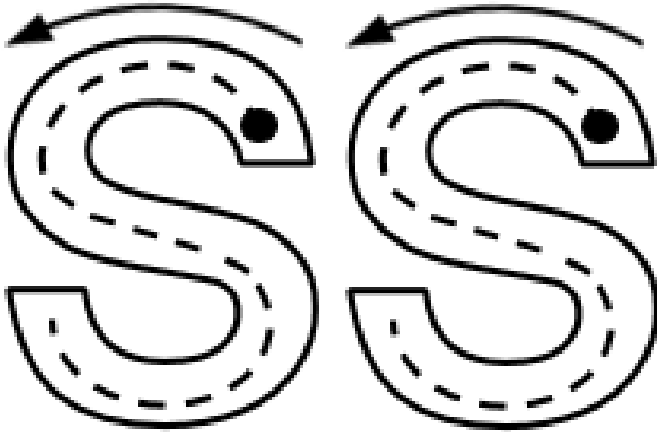

Use the words to complete the sentences.

glass	grass	pass	kiss	dress
-------	-------	------	------	-------

1. The cow is eating _____.
2. I have a pretty, red _____.
3. My father gave my mom a _____.
4. Please _____ me the salt.
5. I am drinking out of a _____.

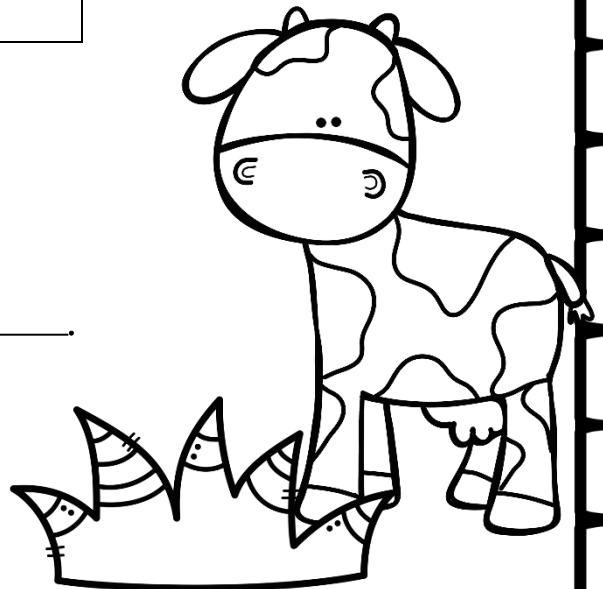

○ Colour the "ing".

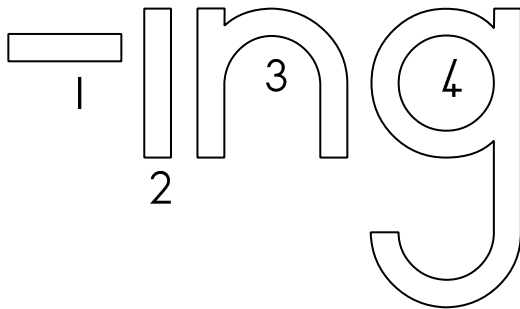

1 - red

2 - blue

3 - yellow

4 - green

• Read the words.

• Underline the -ing sound

sitting	drinking
running	digging
kicking	watering
racing	reading
hitting	eating
singing	climbing
barking	drinking
playing	going
dancing	coming
sleeping	planning

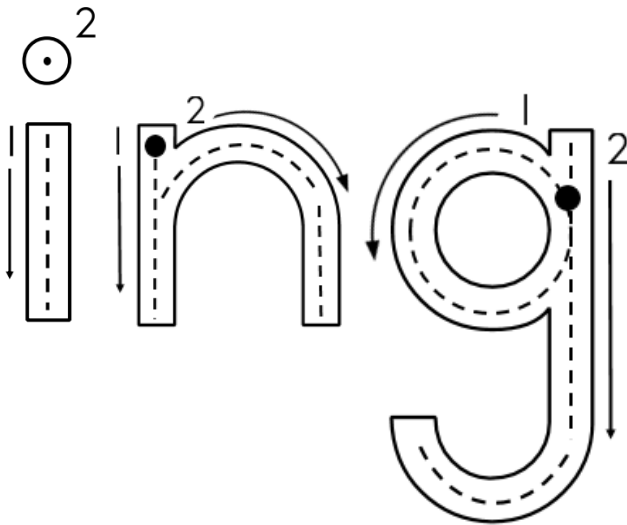

Complete the sentences by using the words in the blocks.

dancing	sitting	kicking	barking	sleeping	drinking
---------	---------	---------	---------	----------	----------

- The boy is _____ the ball.
- The girl is _____ on her bed.
- My dad is _____ on the chair.
- The dog is _____.
- The ballerina is _____.
- She is _____ juice.



Preposition

A preposition shows the position of a noun.

Use the words to complete the sentences.

on

under

in front

between

inside

next to

behind

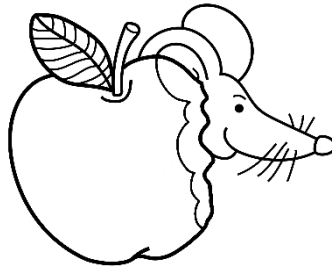
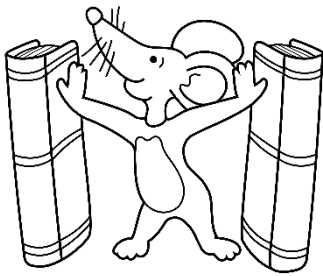

The mouse is standing _____ the mushroom, not in front of it.

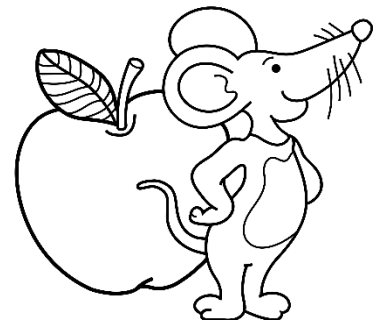
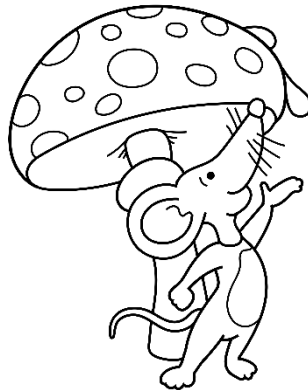

Alphabetical order



- STEP 1 - Look at the first letter of the word, e.g. apple is before door.
- STEP 2 - Look at the second letter of the word, e.g. the "o" in door is before the "p" in apple.
- If the second letter is the same, look at the third letter in the word, e.g. the "l" in bull is before the "s" in bus.

Number each group of words to show the right alphabetical order. Use 1, 2 and 3.

	duck
	cat

	mat
	man

	hen
	hat

a b c d e

	rat
	rot
	red

	hat
	hit
	hot

	rest
	rug
	red

Rhyming words

Rhyming words are words that sounds the same.

Match each word in box 1 with a word in box 2 that rhymes with it.

day		we
out		rang
she		about
sang		May

fly		tune
make		wish
June		cry
fish		cake

Write your own rhyming word for the following words.

road

meal

play

man

heat

rock

Nouns

touch see

A noun is something you can see or touch.

Underline the nouns in each sentence with a colour pencil.

1. David reads a book.
2. The man is eating cake.
3. The dog is chasing a cat.
4. The boy is sitting on a chair.
5. Susan is sitting on the table.

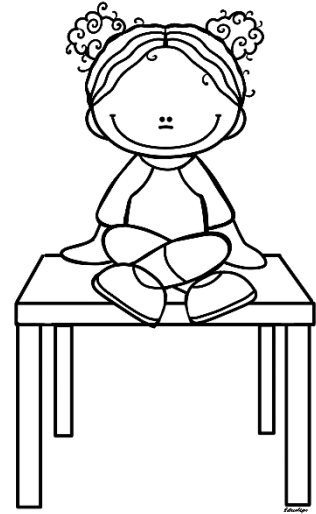

Write the nouns under the correct heading.

Jane Durban pen

book Ben Cape Town

hen

Person

Place

Object