

Grade /
English
Home Language

Term /

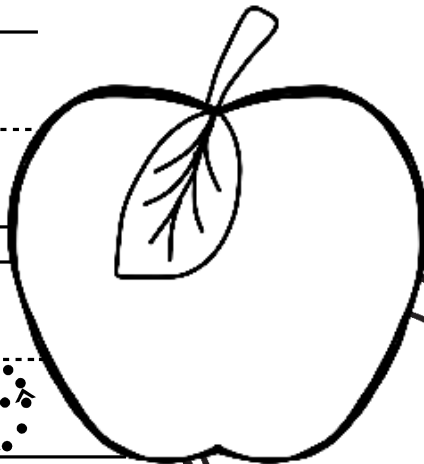
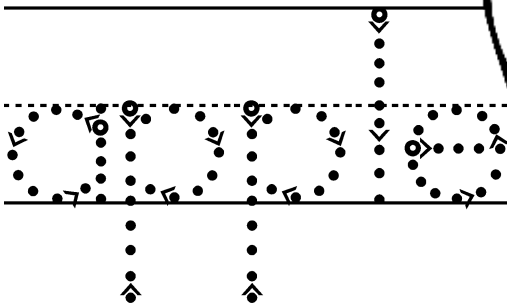
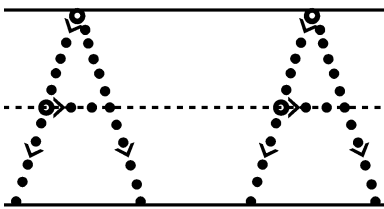
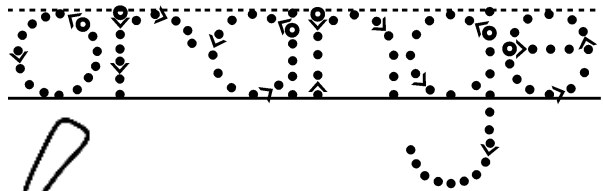
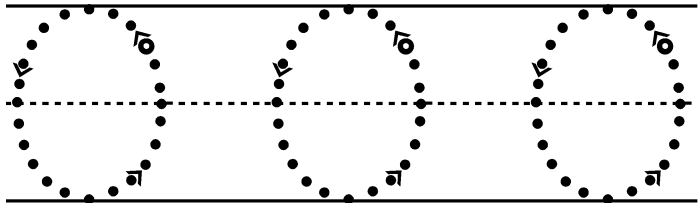
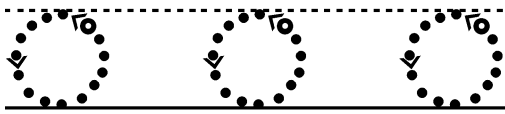
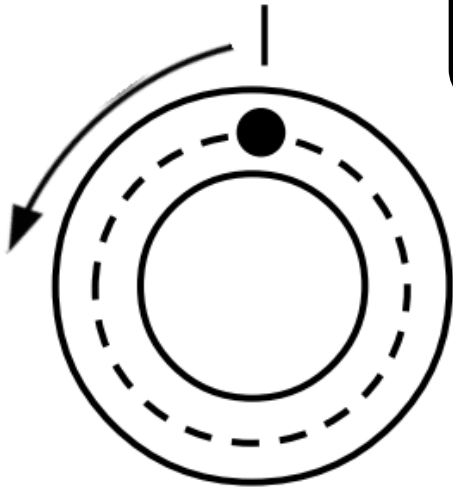

Name:

My name is:

Draw the candles on the cake to show how old you are.

The first letter of my name is:

A J D B
G L O I E
Q F C K H
U M S N P
Z X V W Y
T R

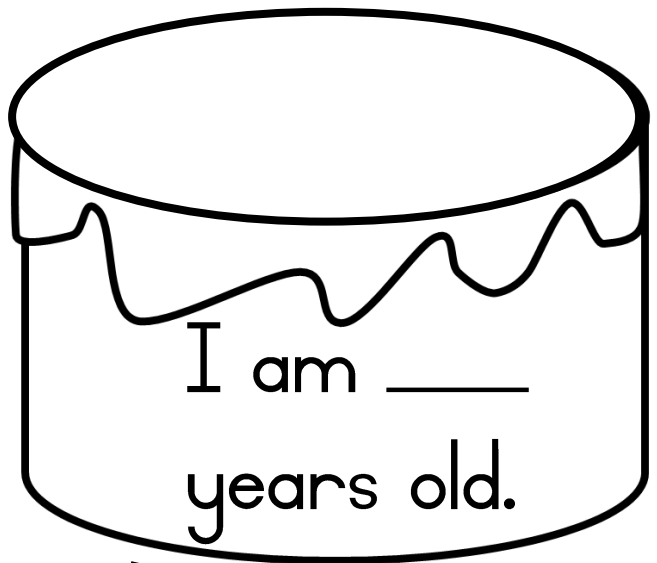

My favourite colour is:

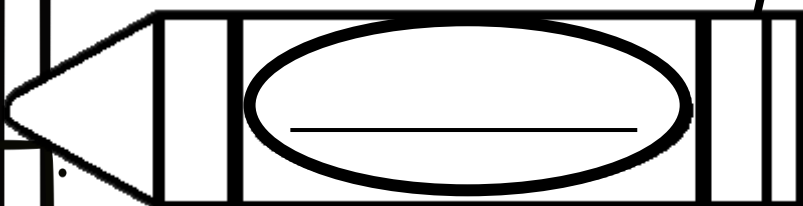

My fingerprint



My body

hair

head

eyes

arms

legs

stomach

big

toes

foot

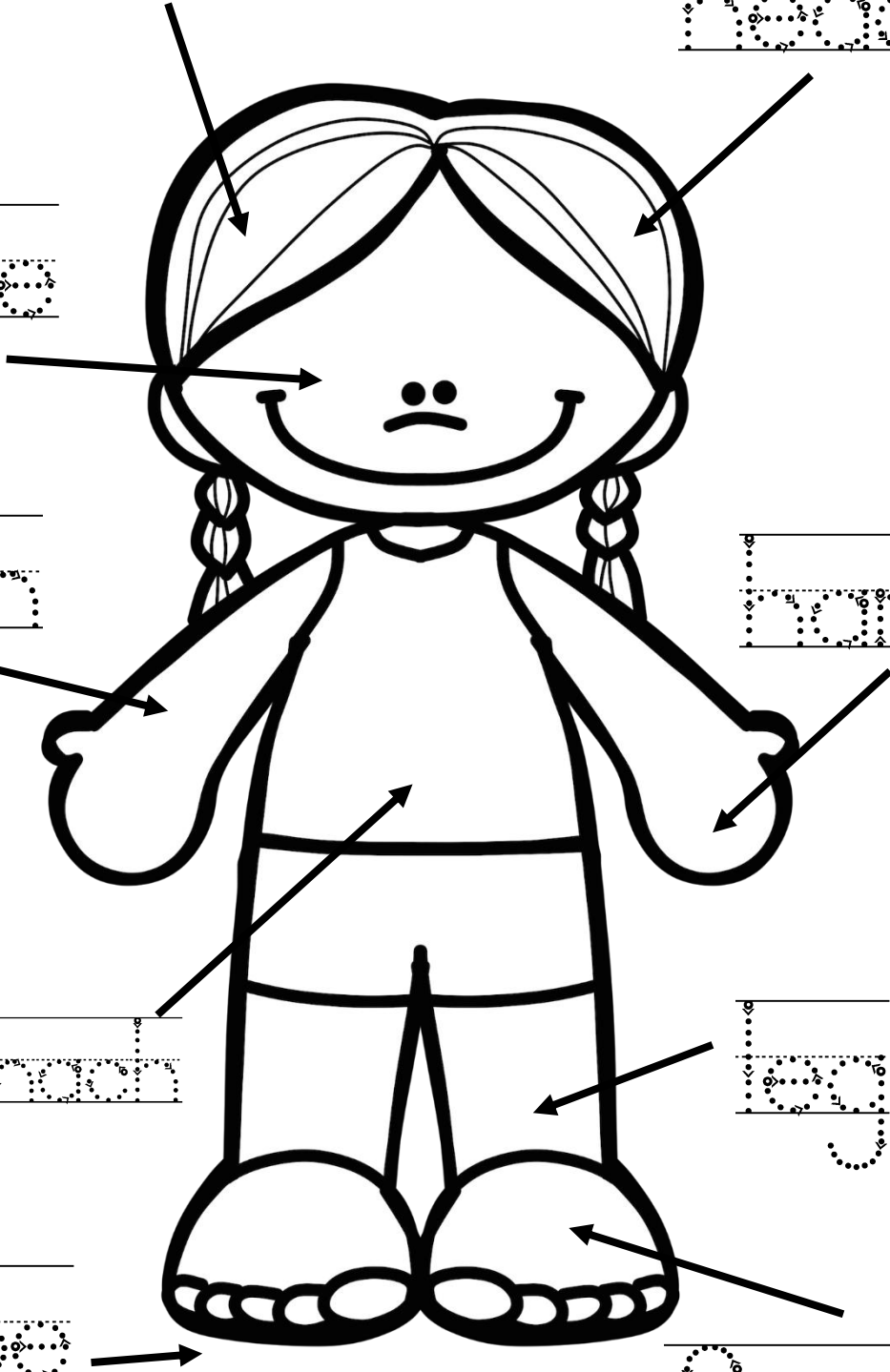

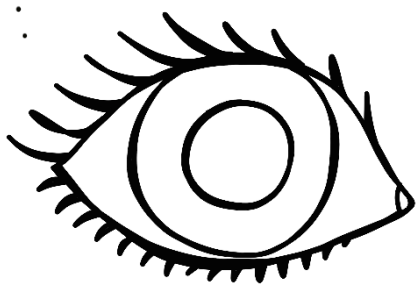

eye

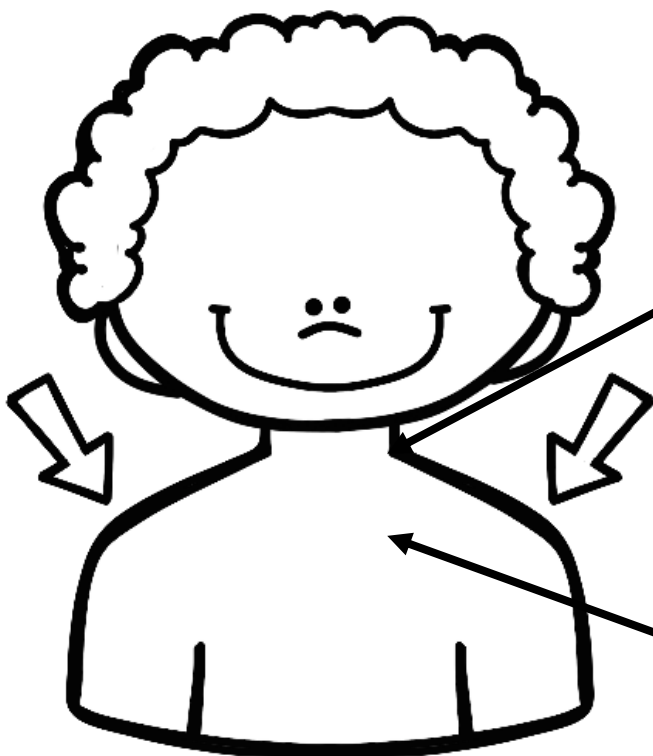

neck

shoulders

chest

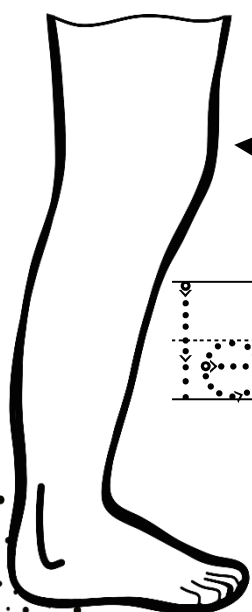

leg

leg

mouth

foot

toes

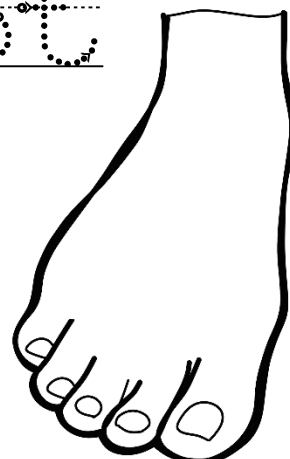

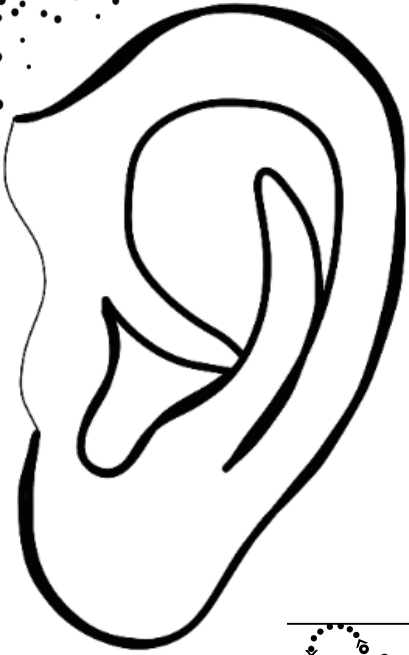

ear

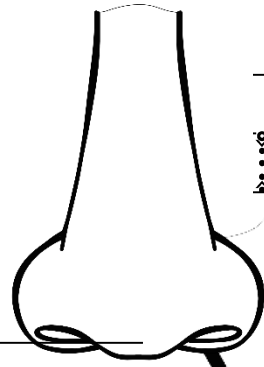

nose

arm

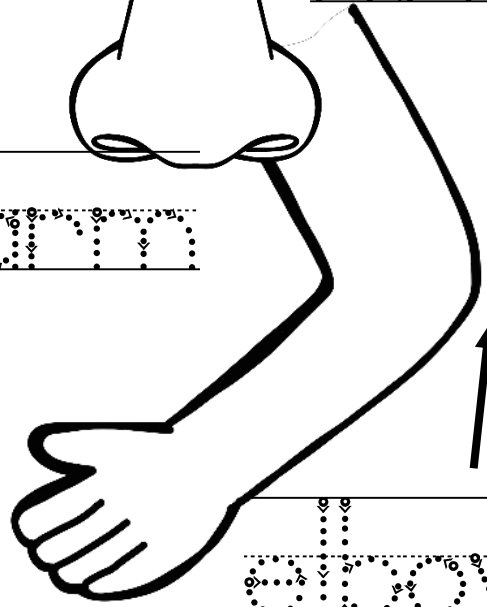

elbow

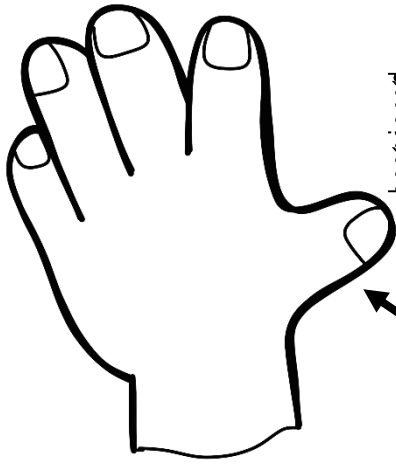

finger

thumb

thumb

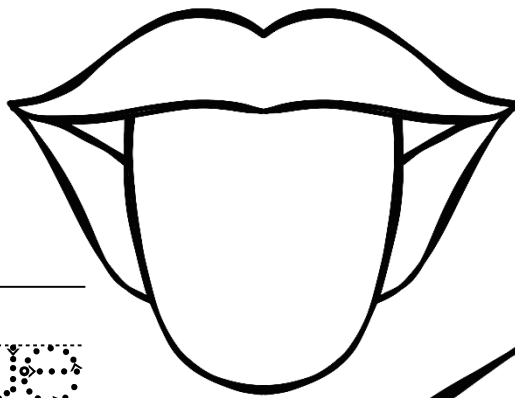

taste

tongue

mouth

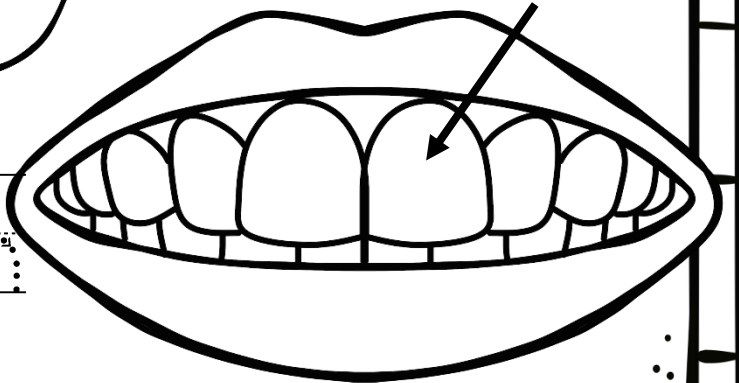



Trace your left hand.

Trace your right hand.



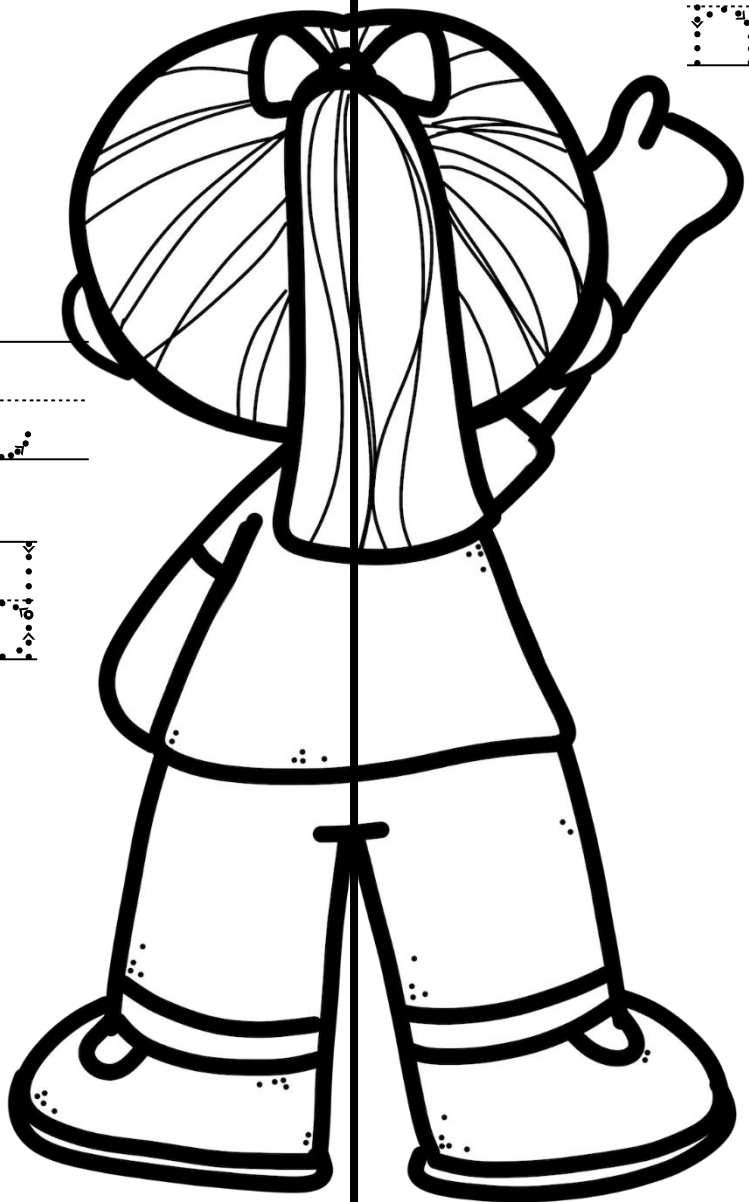

right
foot

left
foot

right
foot

left
foot

Numbers 1 to 10

1

one

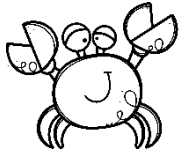

2

two

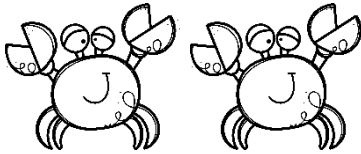

3

three

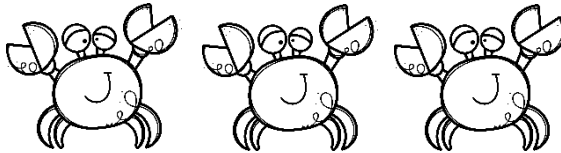

4

four

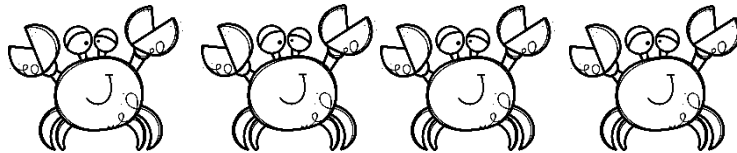

5

five



6

six



7

seven



8

eight



9

nine



10

ten



Complete the numbers in the sea stars.

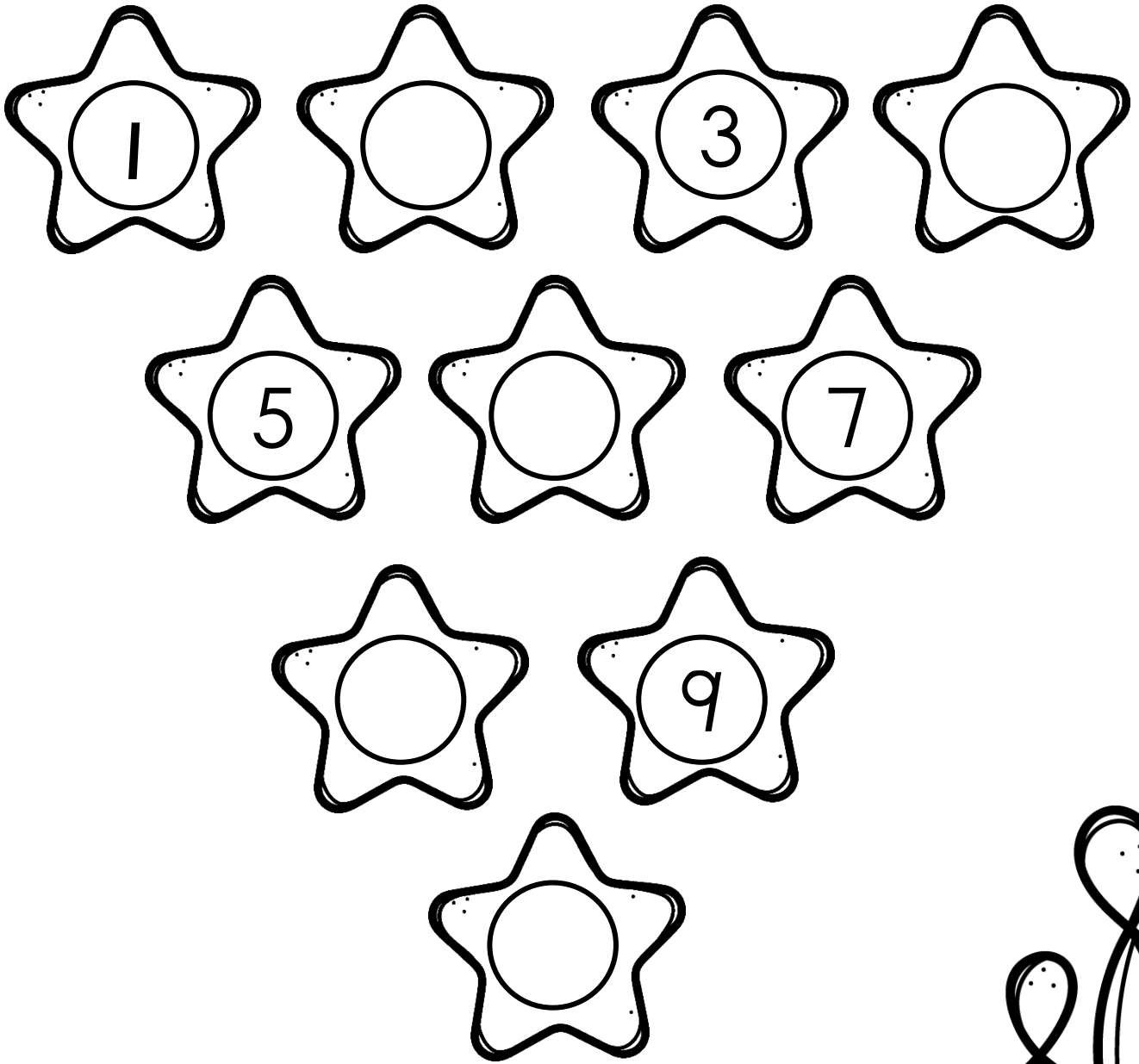

Practice the words.

one	two	three	four	five
six	seven	eight	nine	ten

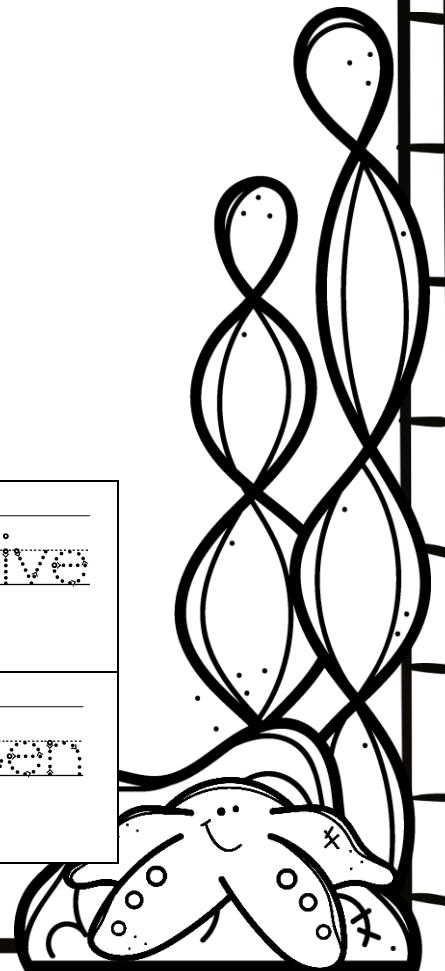

Match the number with the correct amount of pictures by drawing a line.

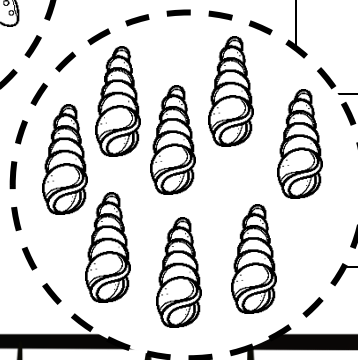
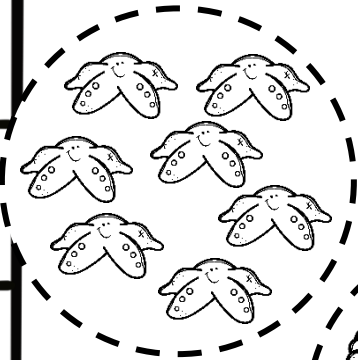
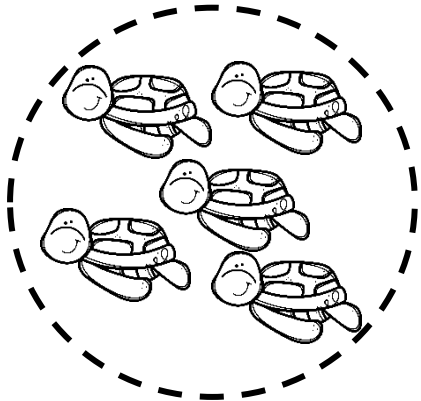
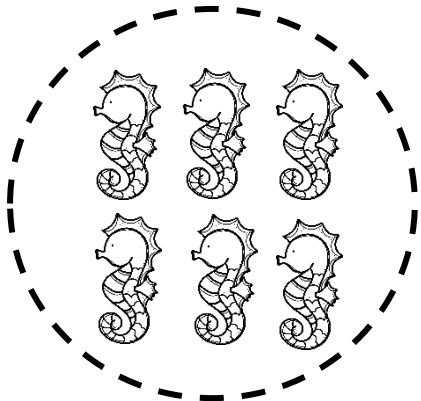
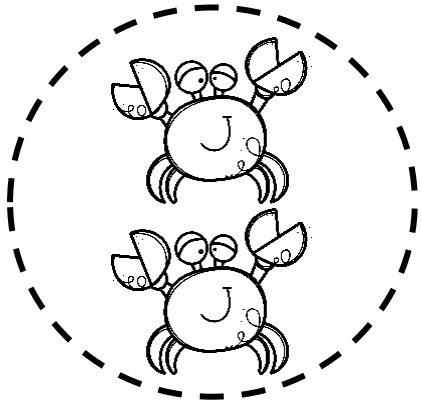

1
2
3
4
5
6
7
8
9
10

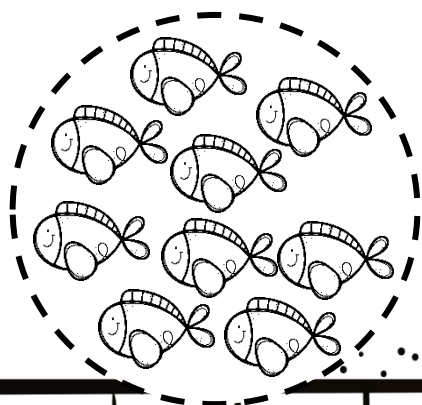
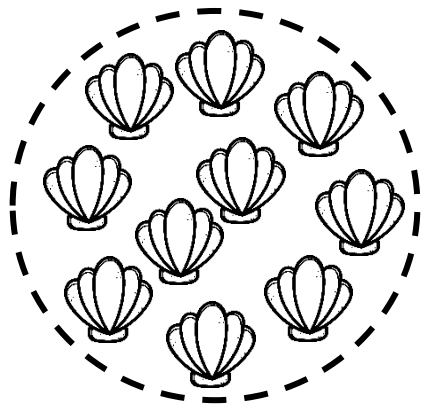
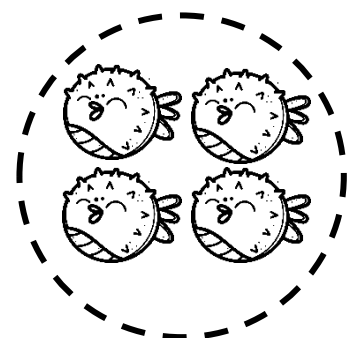
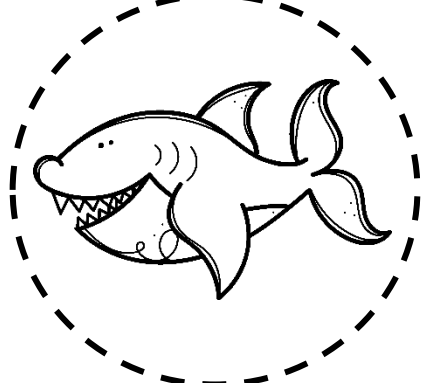
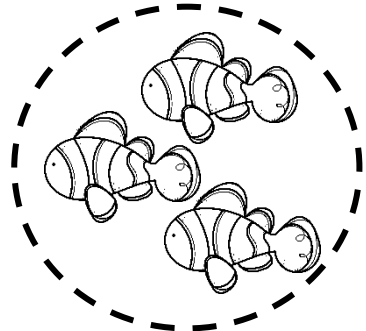

Trace and read the words.
Colour the pictures the correct colour.

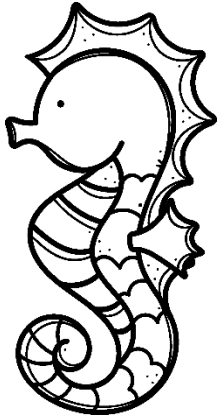

seahorse

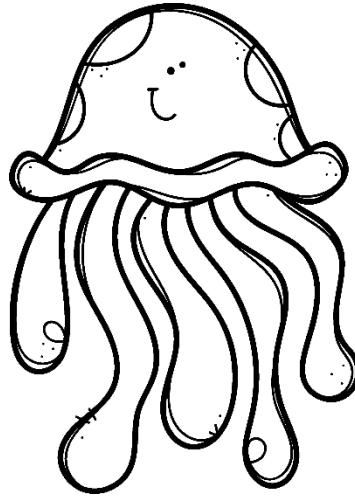

jellyfish

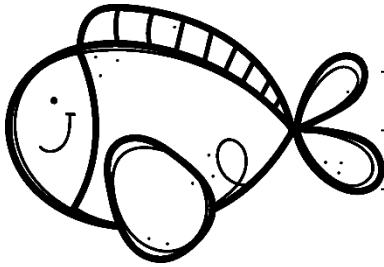

clownfish



pufferfish

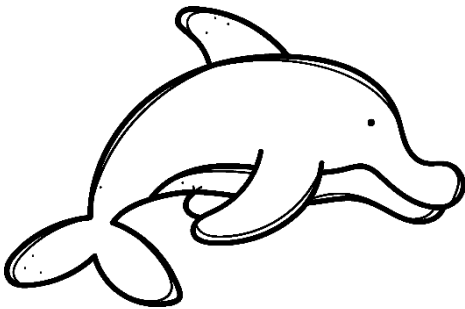

dolphin

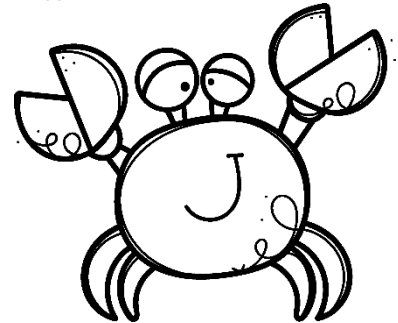

crab

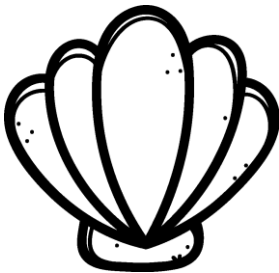

seashell



squid

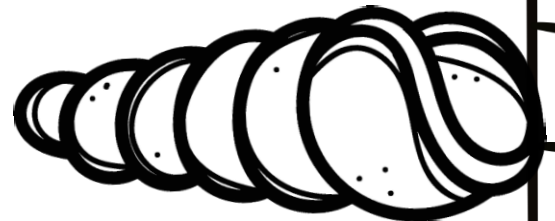

nautilus

Insect fun

Help the insects to get to the flower.

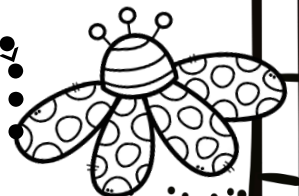
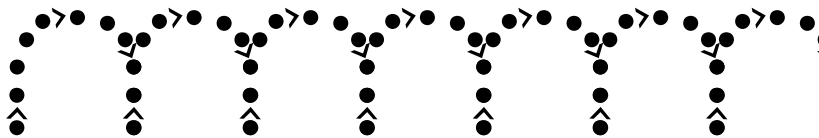
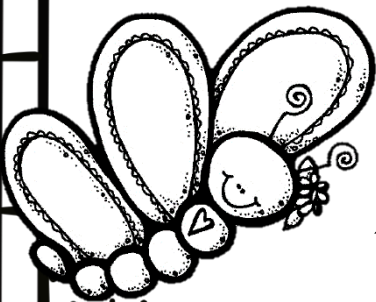
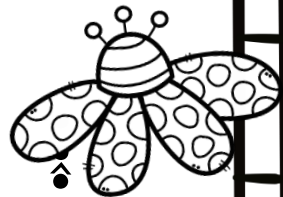
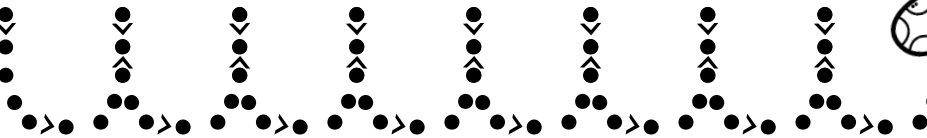
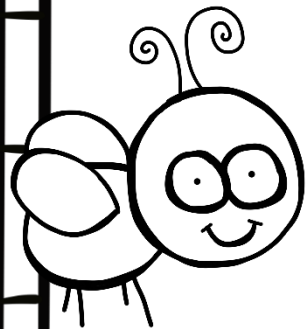
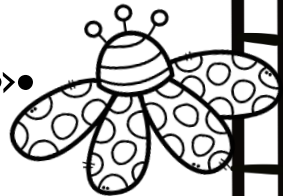
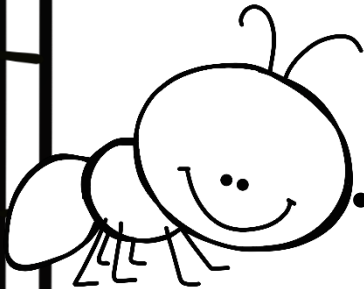
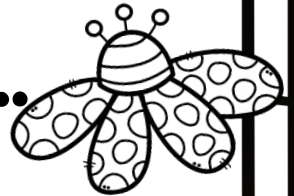
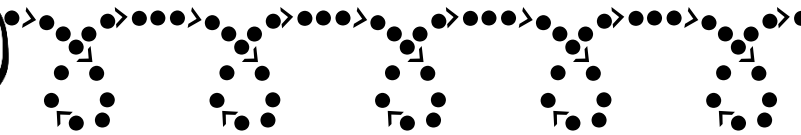
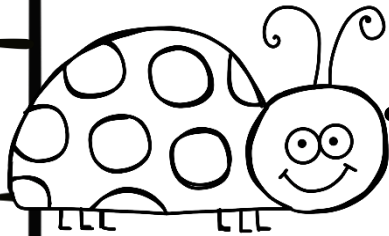
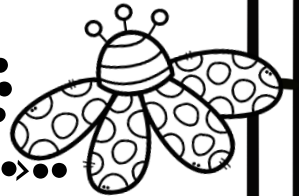
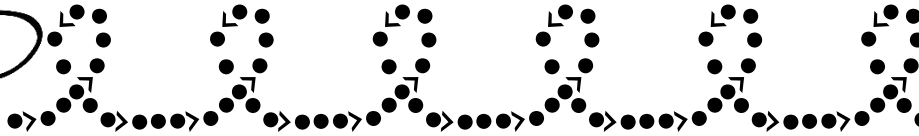
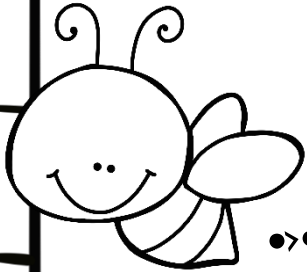



Hop like a rabbit to reach the carrot.

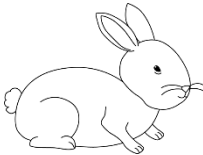
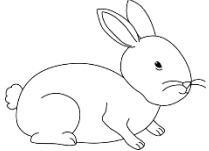

Hop like a frog.

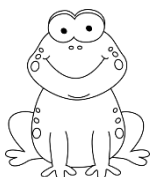
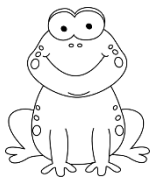
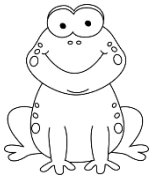
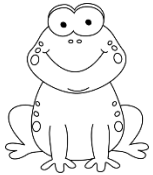



Swim like a dolphin
over the waves.



Complete the rest of the line with waves.



Gallop like a horse.



Complete the rest of the line.

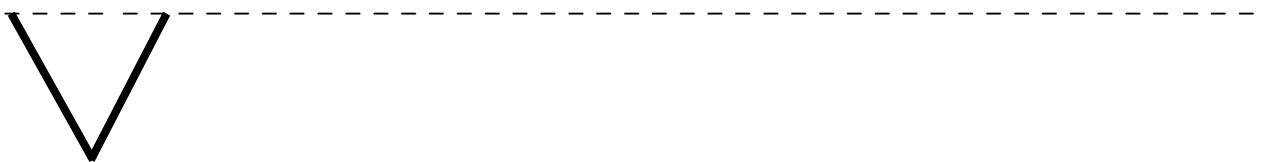

Monkey swing

Show the monkey how to swing by completing the pattern.

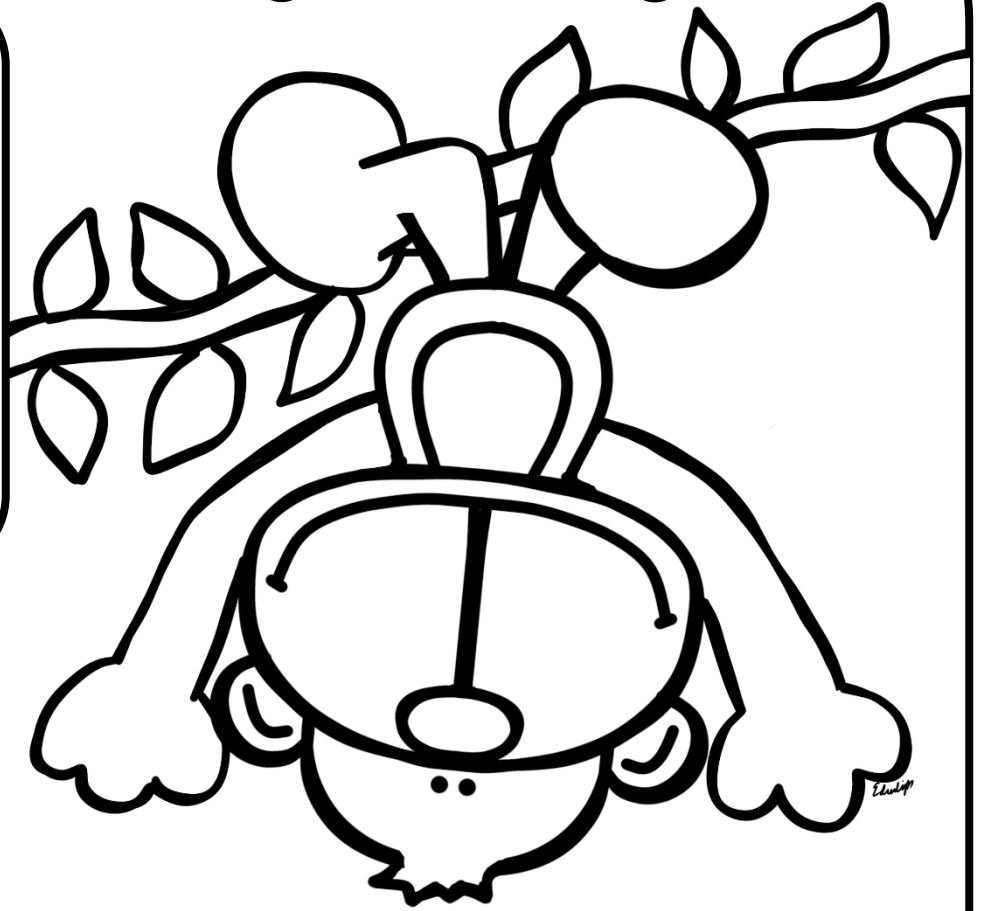

Swing with Tarzan
through the woods.



Colour the pictures that begin with the sound.

a

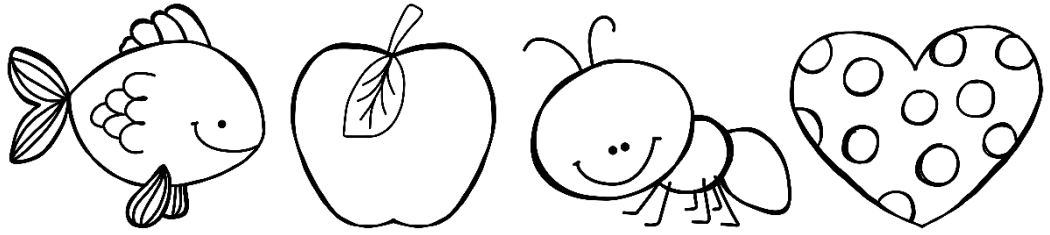

s

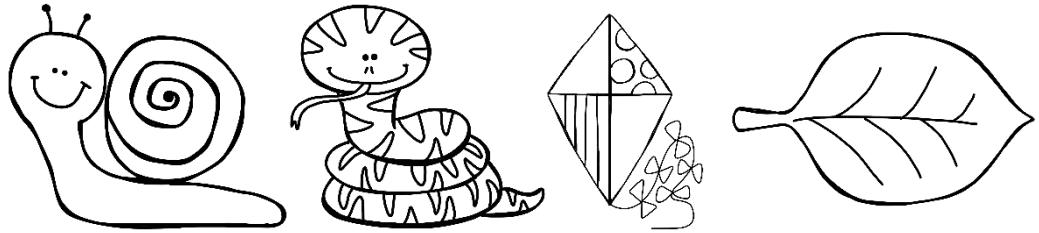

b

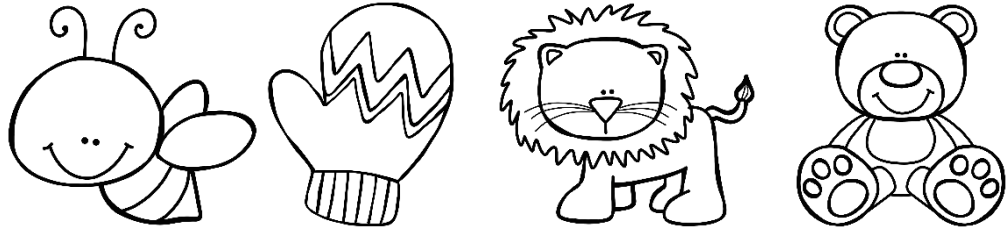

m

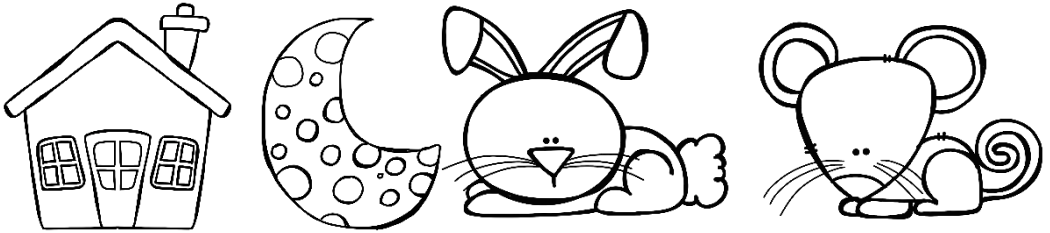

k

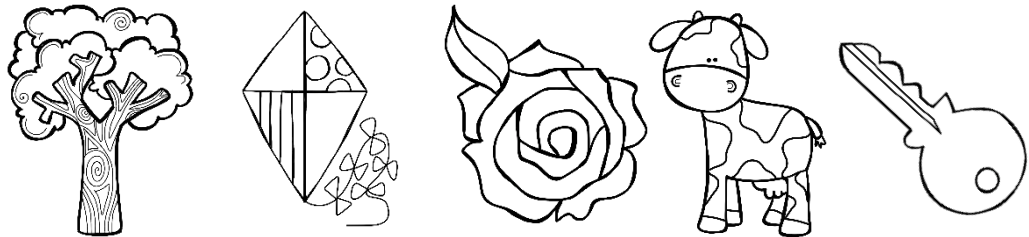

e

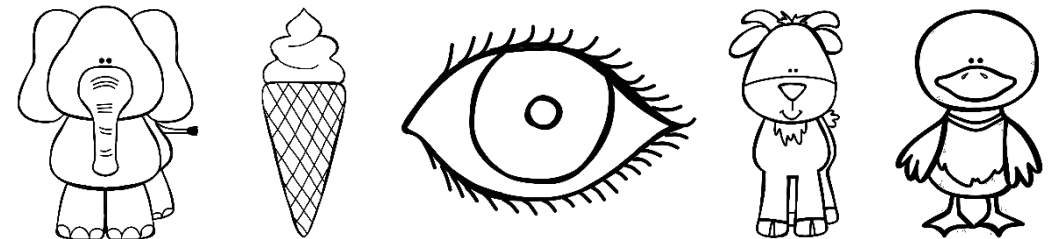

a

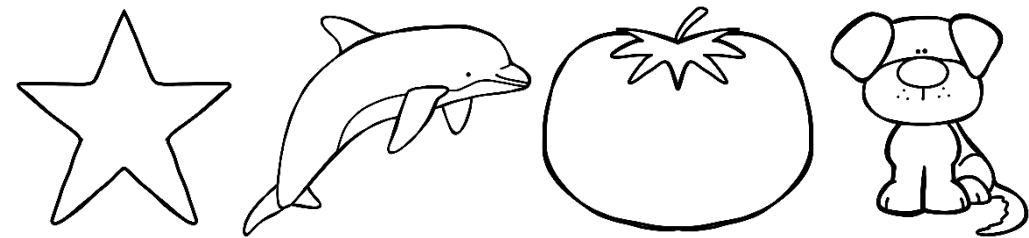

Beginning sound

With which letter do the following words begin?

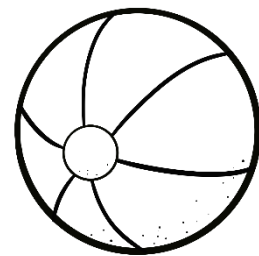
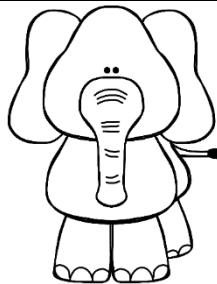
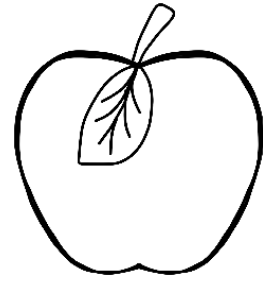
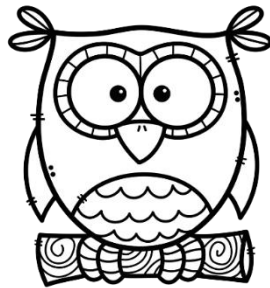
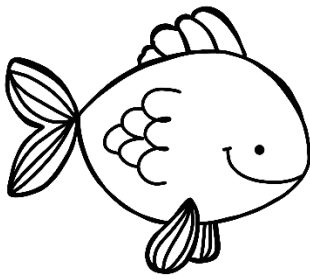
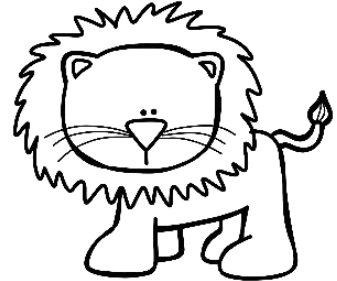
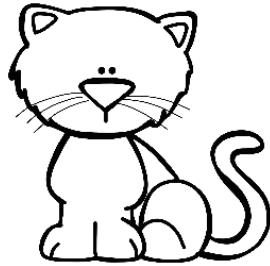

Colour the letter.

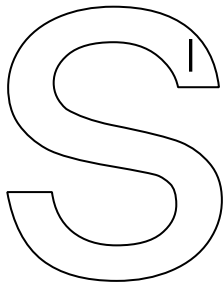

l - purple

Read the words.

Sam	sits	sat	sad	snake
sit	sun	sand	star	socks

Trace over the letter.



Circle all the "s" letters.

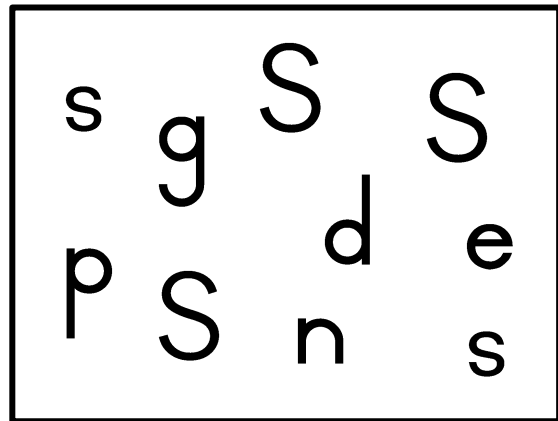

Practice writing the letter.

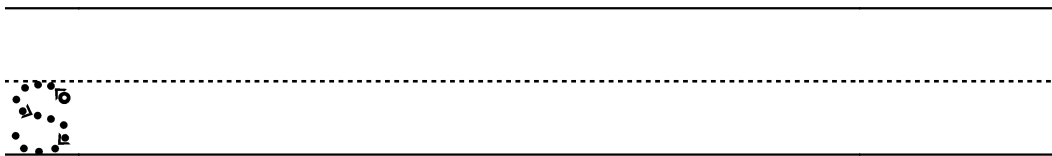

Trace the words.

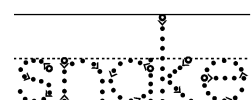
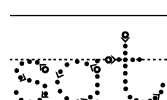
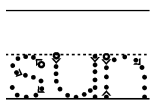
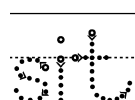
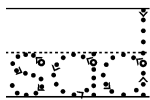
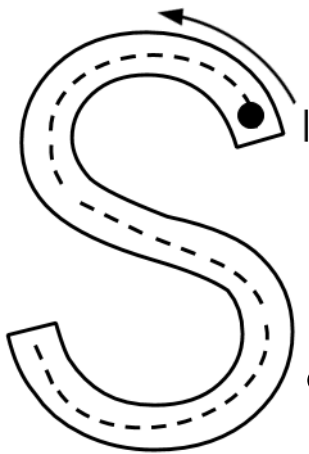

Practice writing the capital letter.

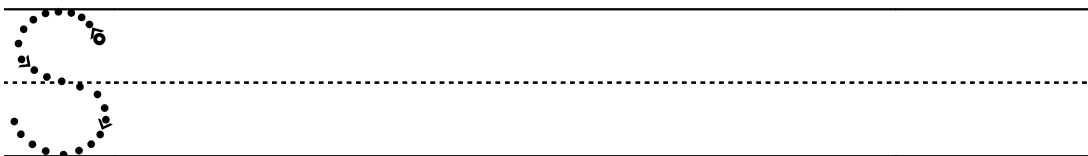

"s" sound

Colour all the pictures that start with the "s" sound.

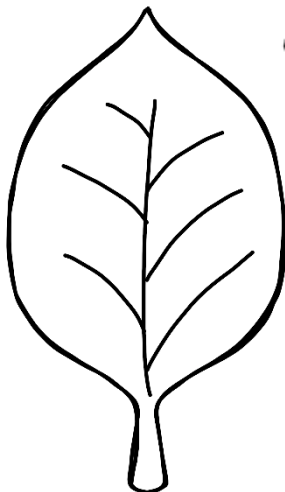
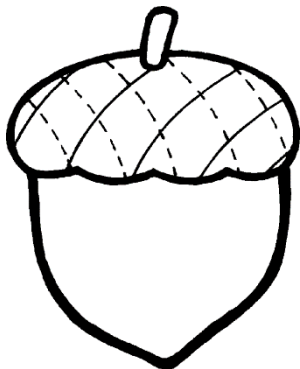
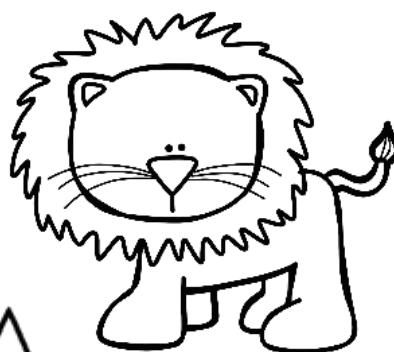
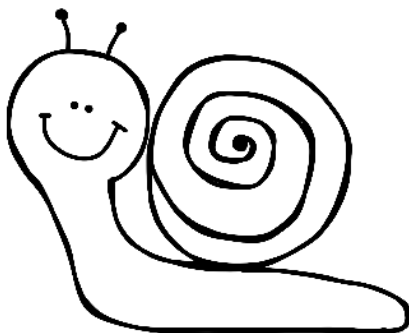
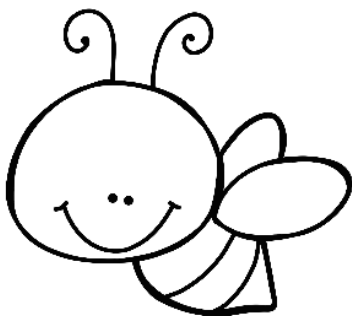
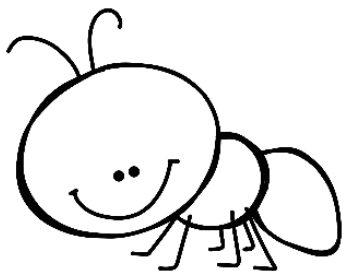
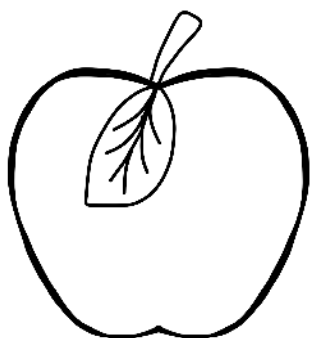

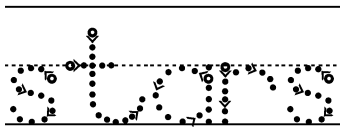
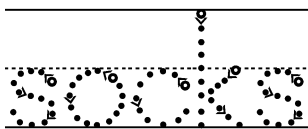
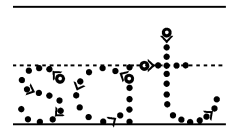
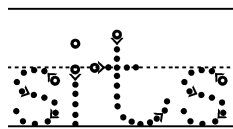
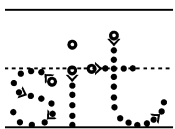
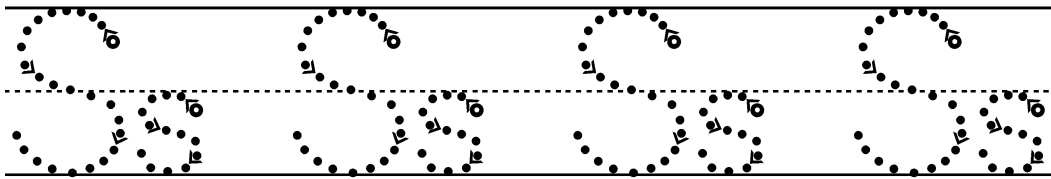
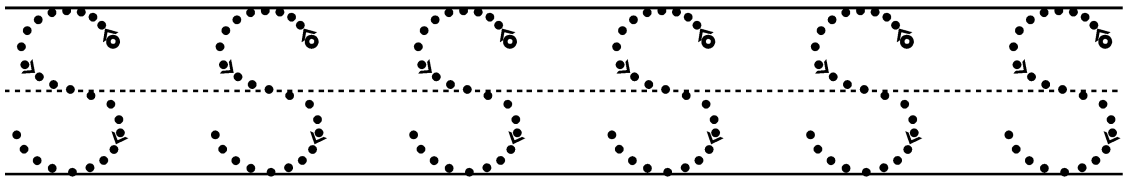
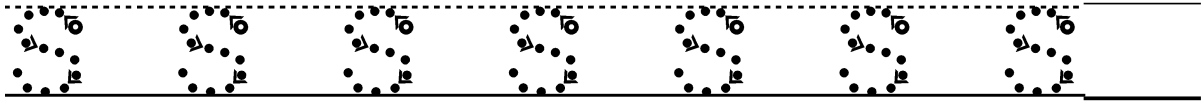
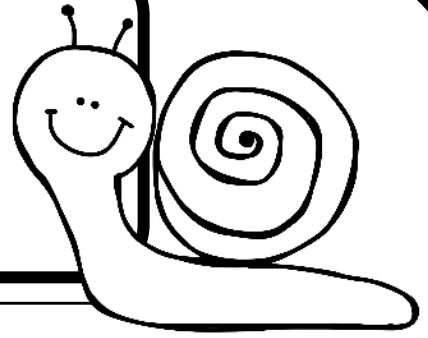
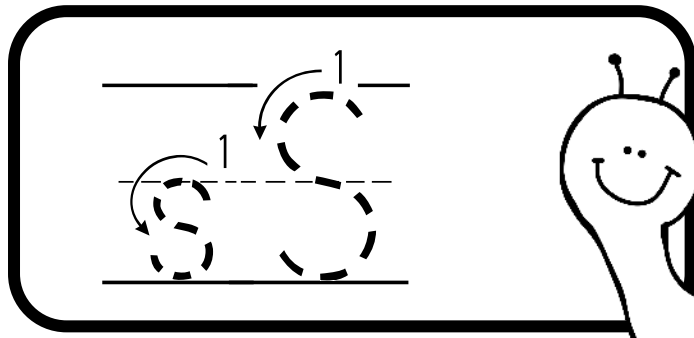

Colour the letter. 1 - red

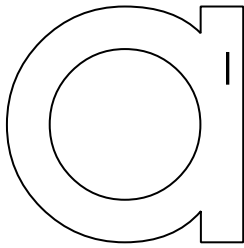

Read the words.

an	ant	apple	ambulance
as	Sam	Ann	

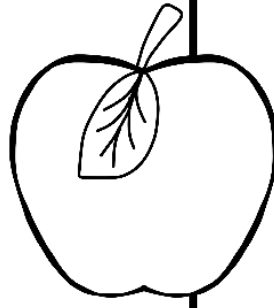
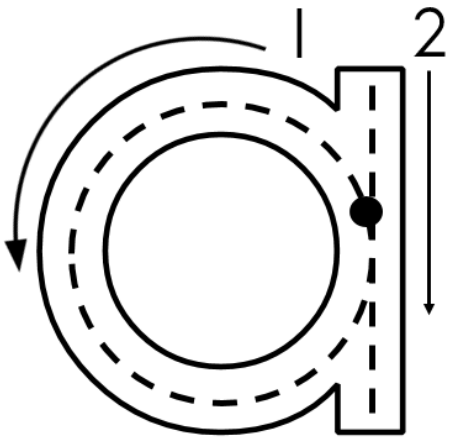

Circle all the "a" letters.

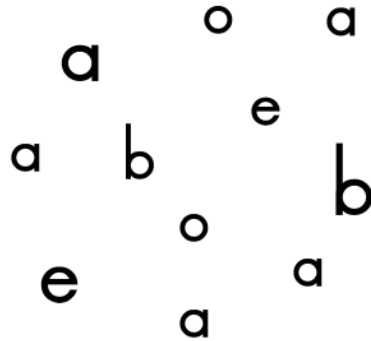

Practice writing the letter.

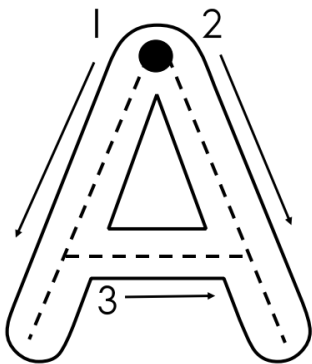
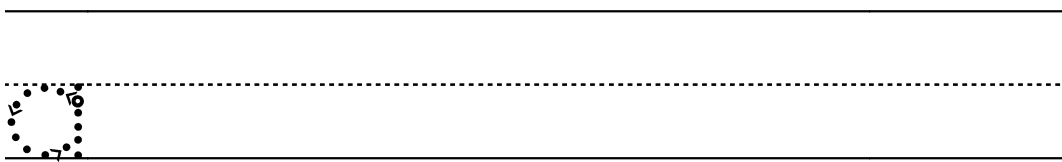

Practice writing the capital letter.

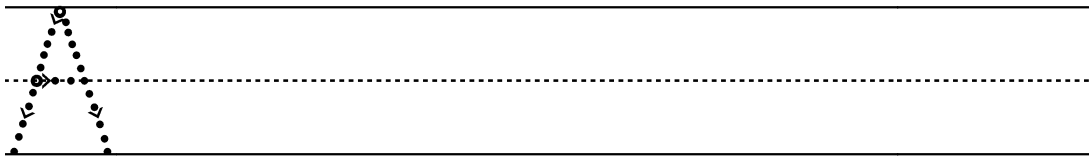

"a" sound

Colour all the pictures that start with the "a" sound.

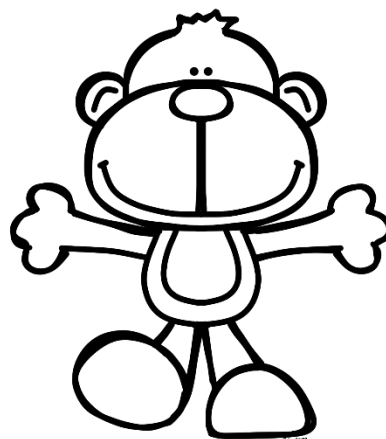
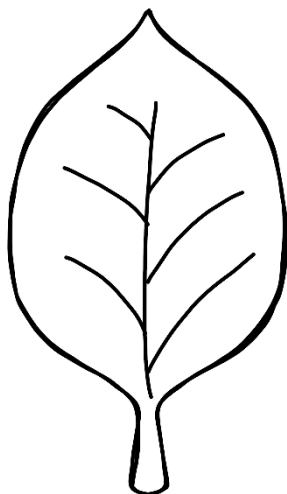
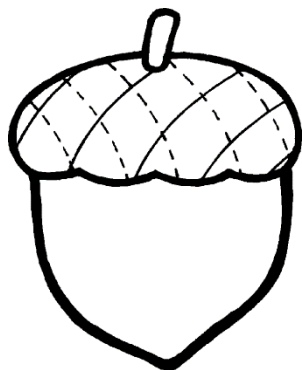
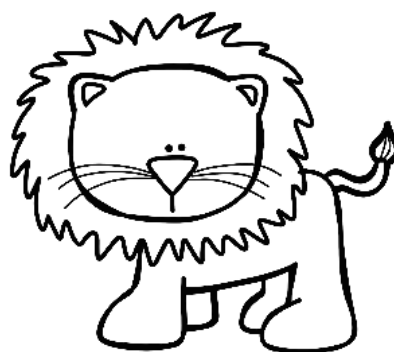
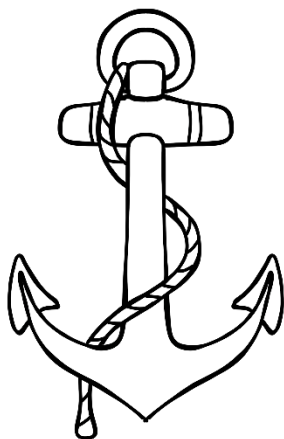
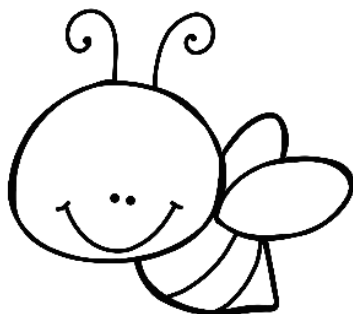
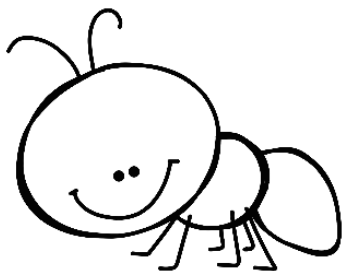
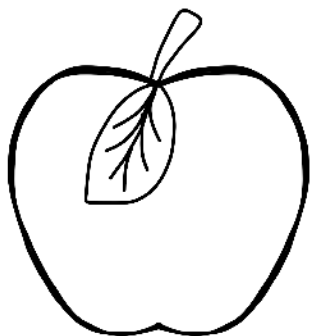

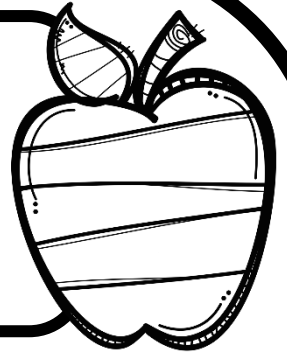
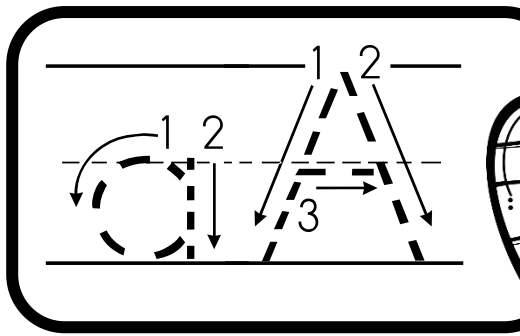

o o o o o o o

A A A A A A A

o o

A A

o o o o o

o o



Colour the pictures that match the first one.

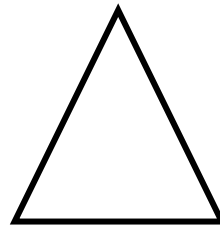
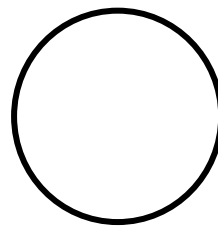
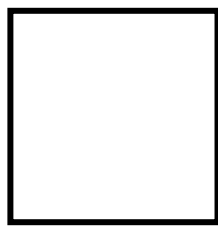
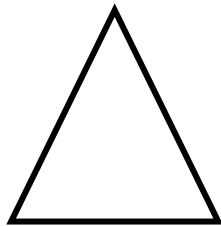
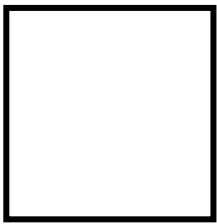
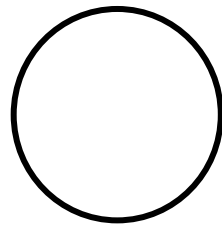
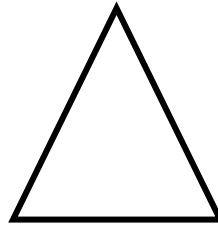
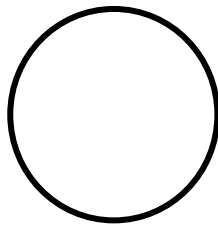
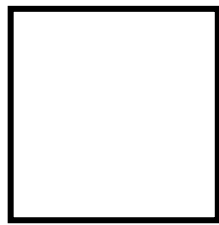
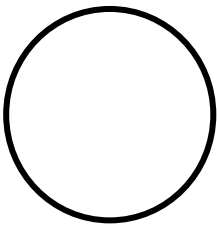
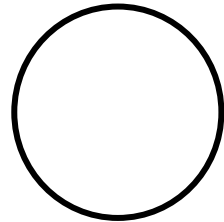
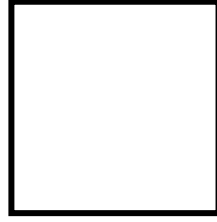
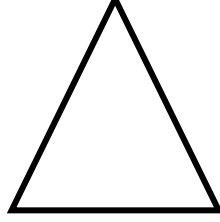
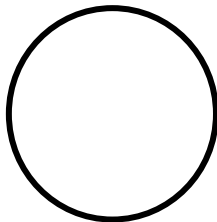
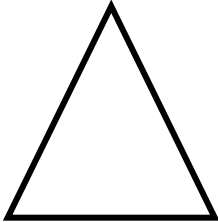
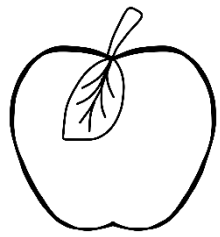
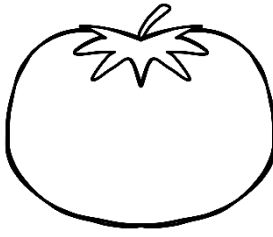
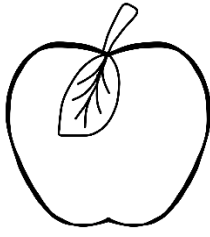
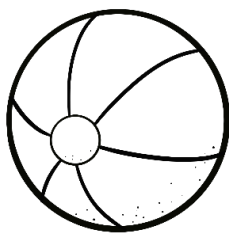
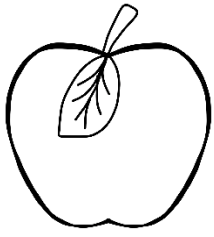

a

a

d

b

a

g

a

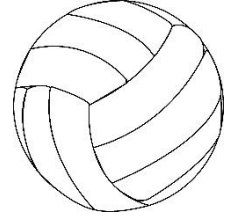
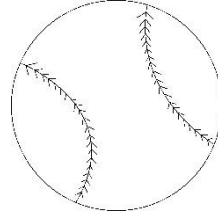
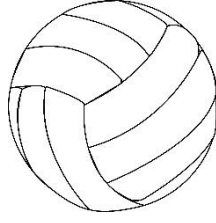
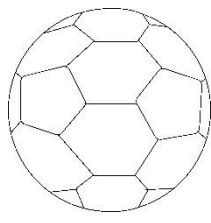
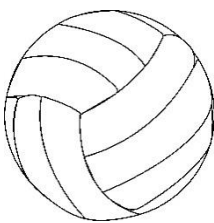

Colour the letter. 1 - pink

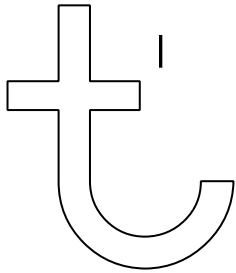

Read the words.

tent	tip	top	tea
ten	tin	tap	tractor

Trace the letter.

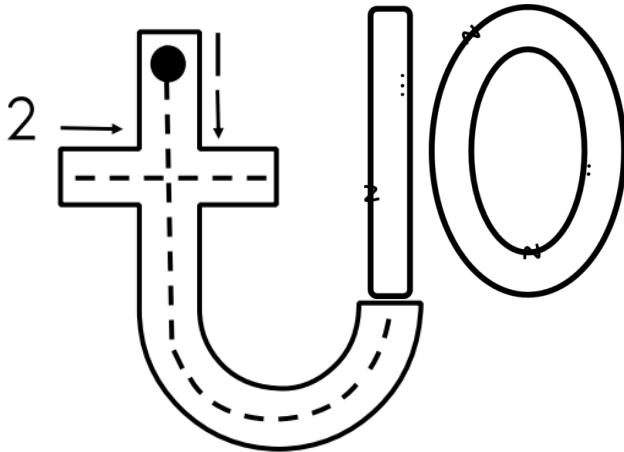

Circle the "t" letters.

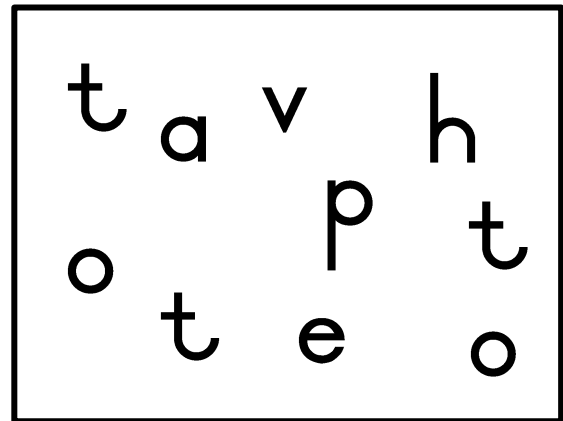

Practice writing the letter.

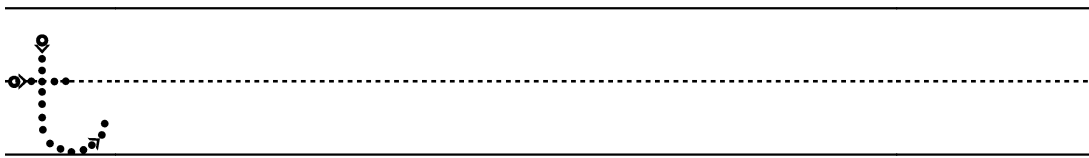

Complete the "t" sound in the words.

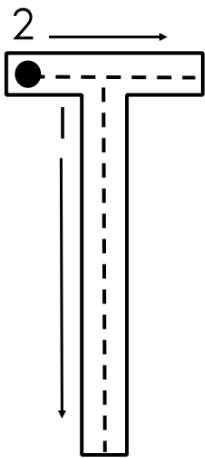

__en

__in

__ent

__ap

Practice writing the capital letter.

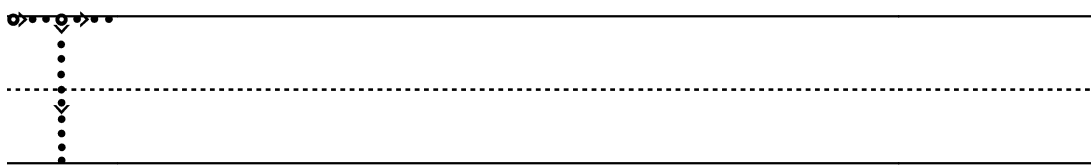

"t" sound

Colour all the pictures that start with the "t" sound.

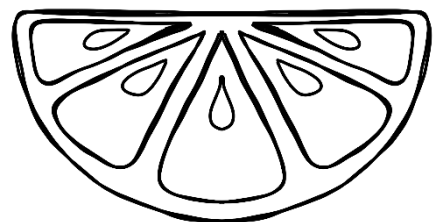
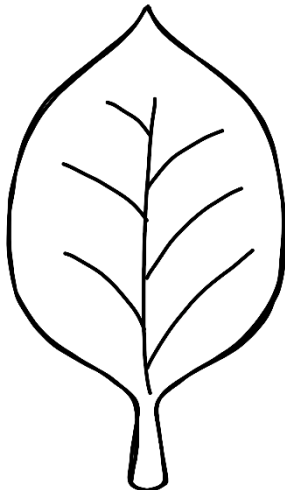
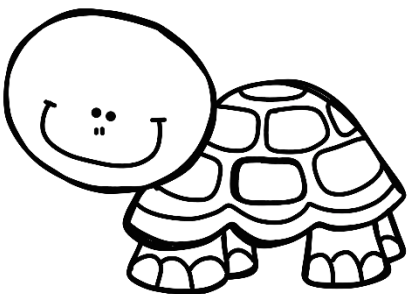
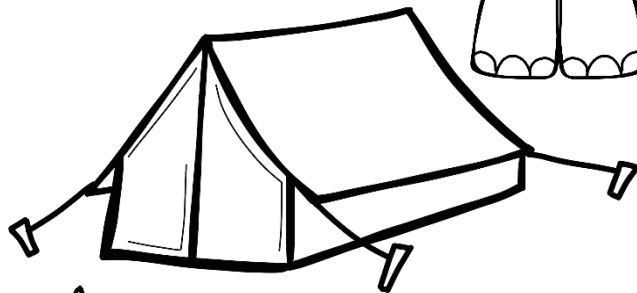
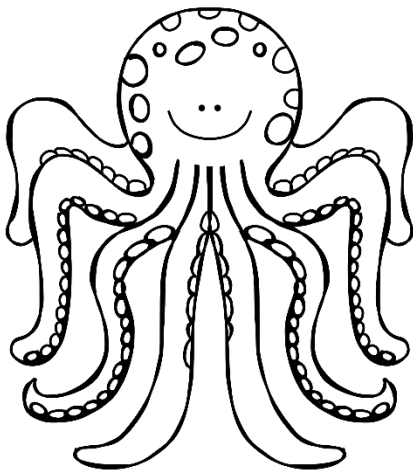
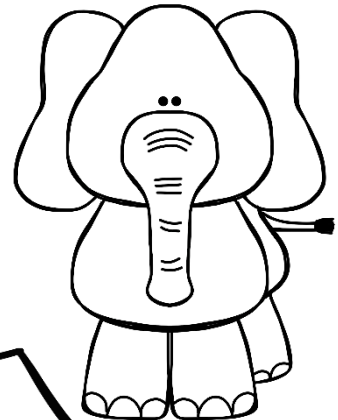
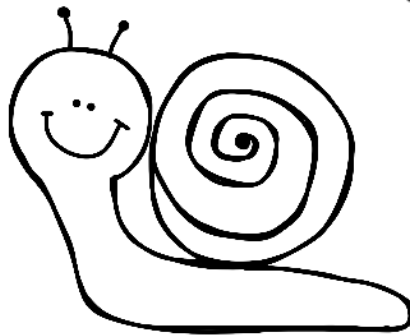
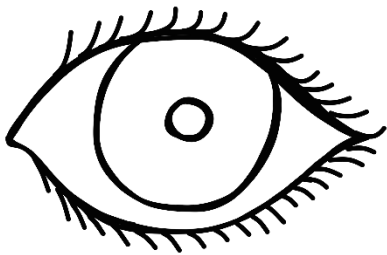
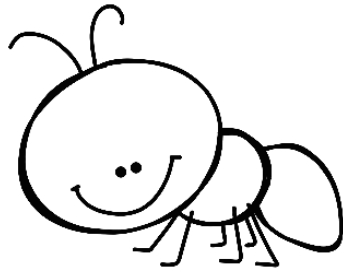
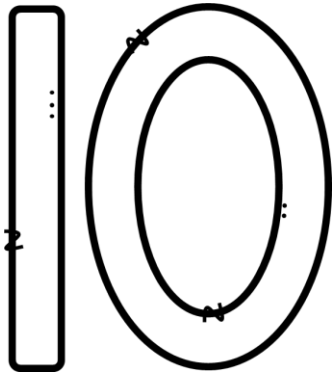

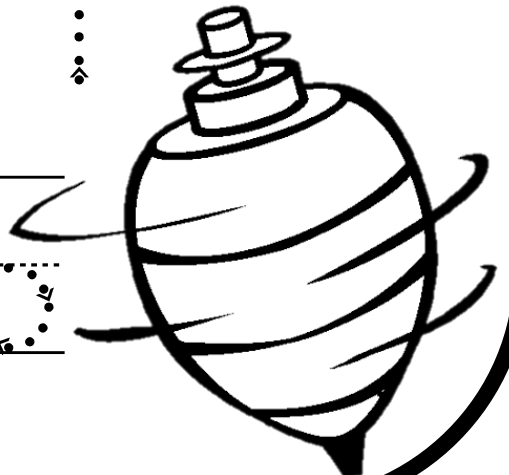
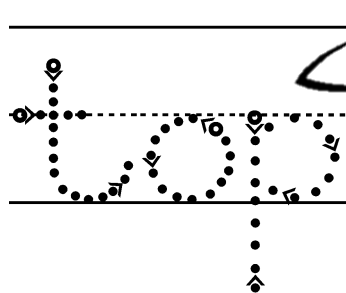
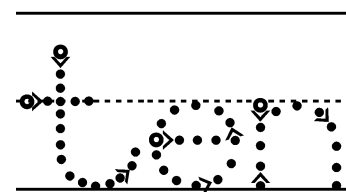
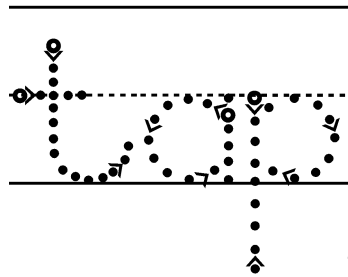
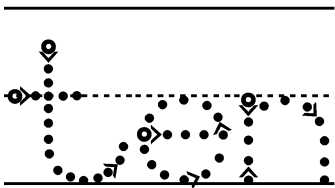
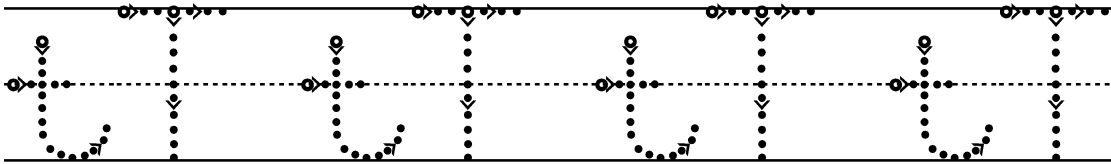
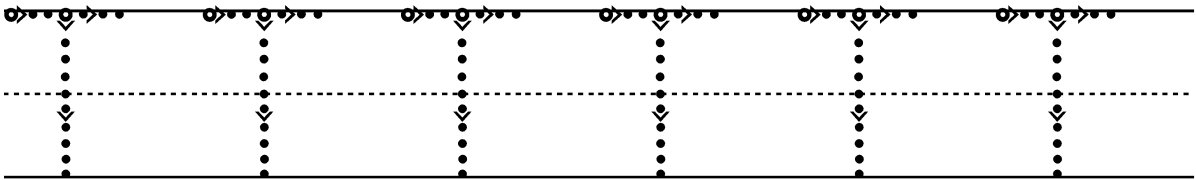
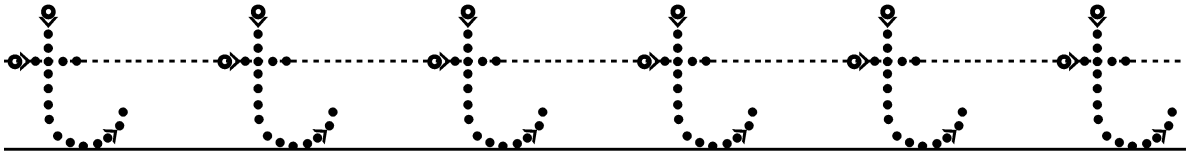
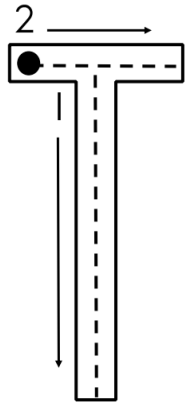
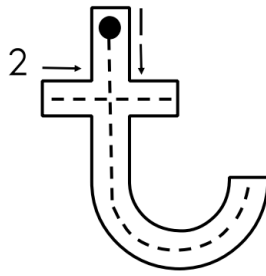
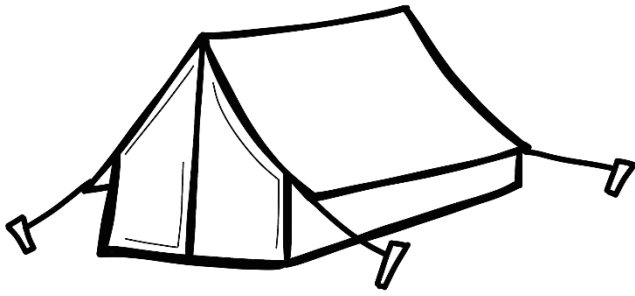

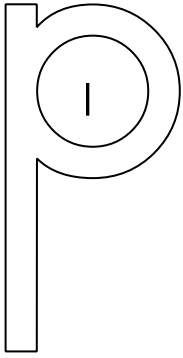

Colour the letter.

l - orange

Read the words.

pet	pot	pig
pup	pen	pan

Trace the letter.

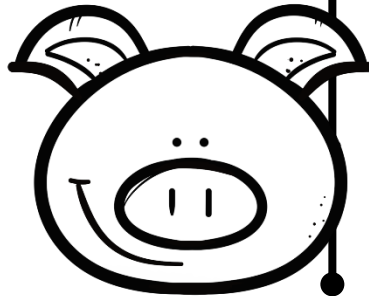
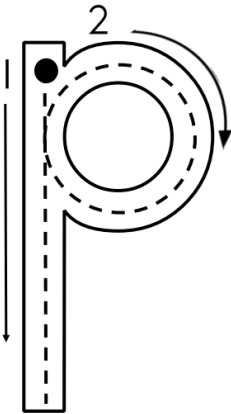

Circle all the "p" sounds.

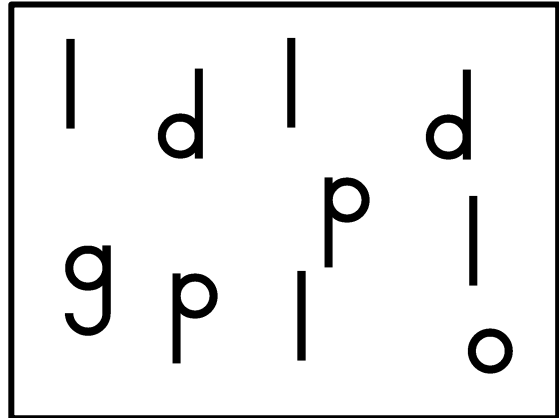

Practice writing the letter.

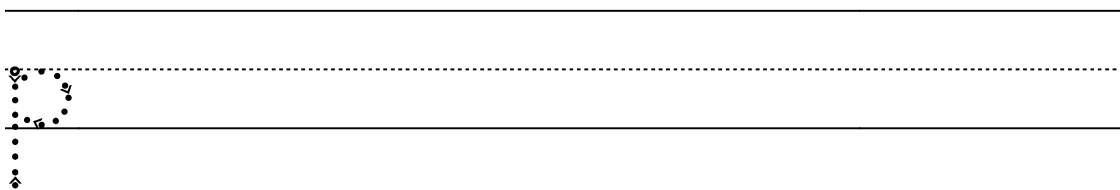

Complete the "p" sound in the words.

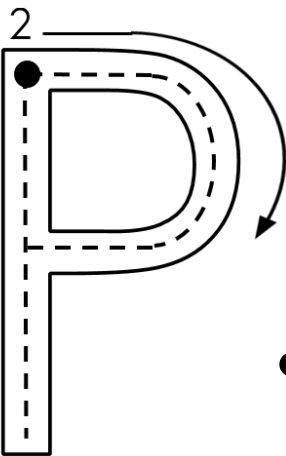

__ig

__en

__aint

__encil

Practice writing the capital letter.

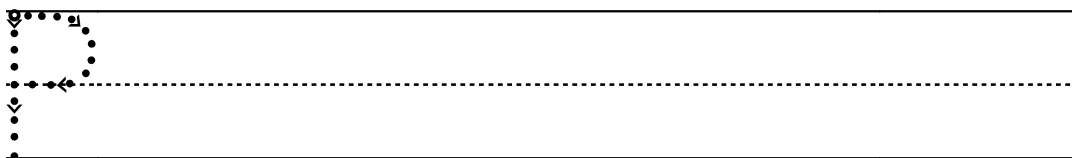

"p" sound

Colour all the pictures that start with the "p" sound.

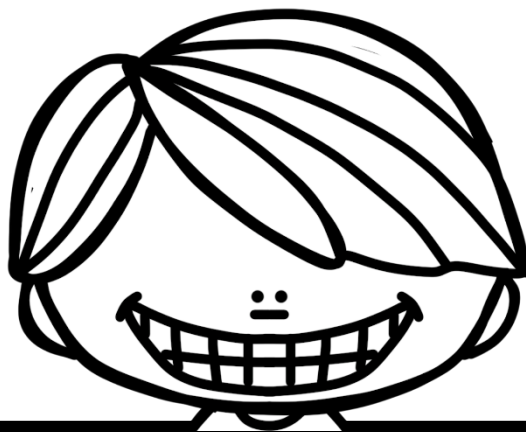
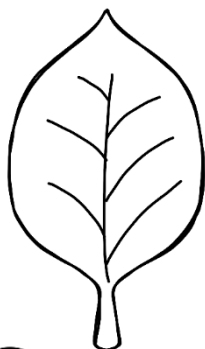
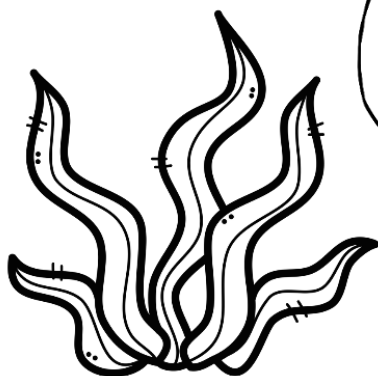
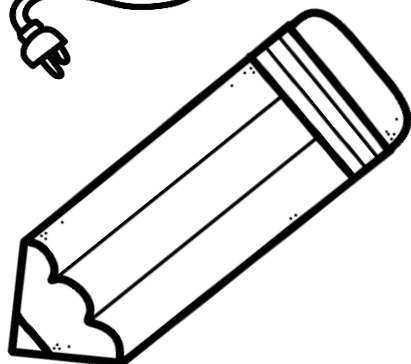
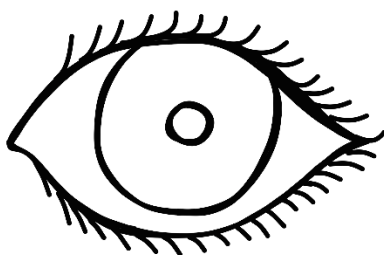
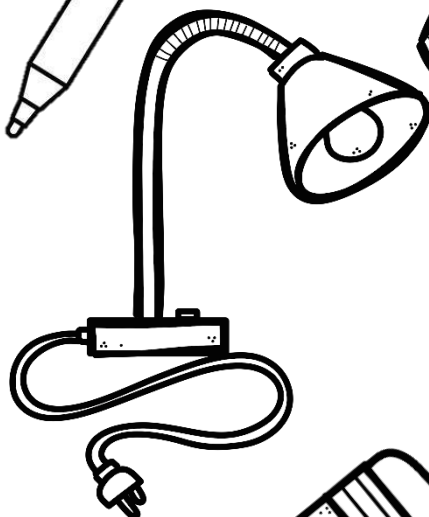
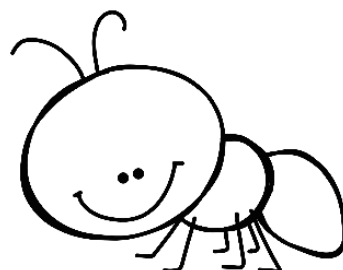
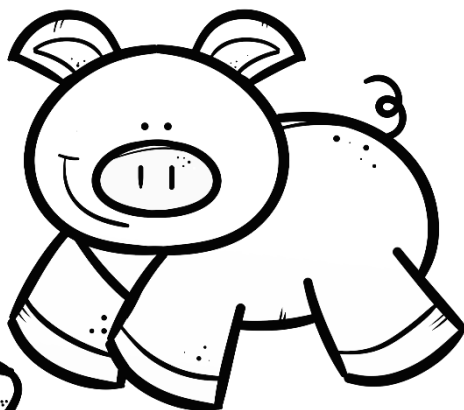
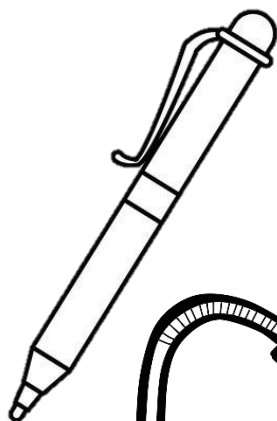

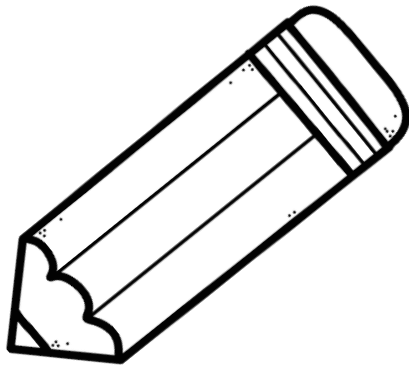
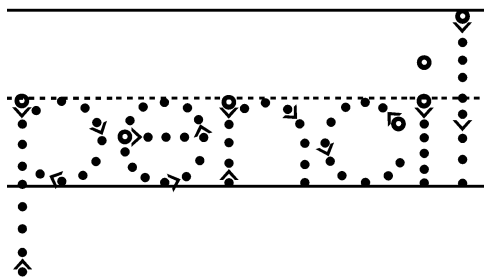
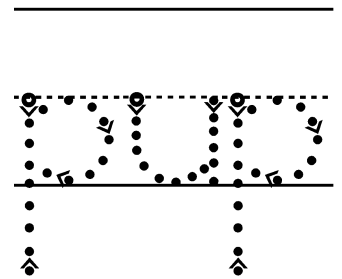
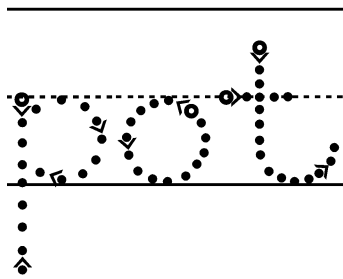
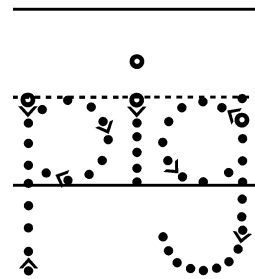
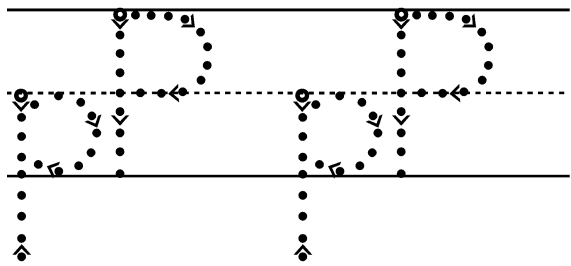
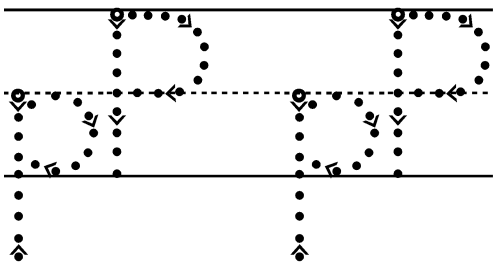
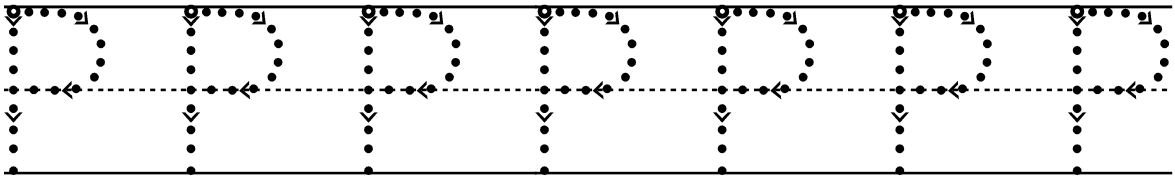
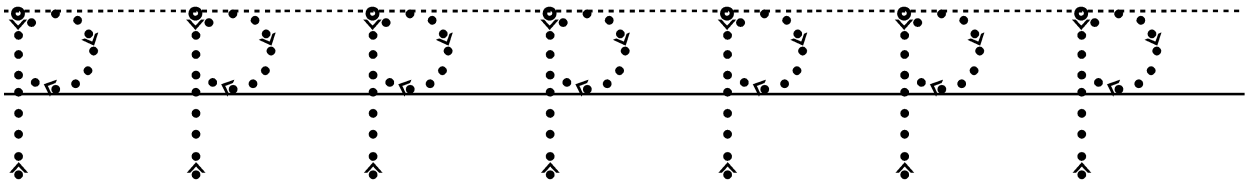
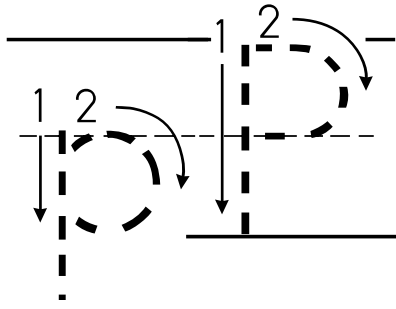
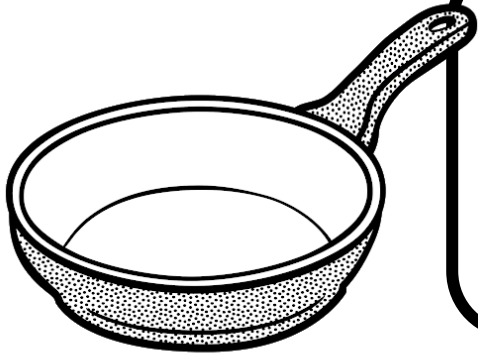

2
○

Colour the letter.



1 - purple

2 - green

Read the words.

it	is	in
sit	tin	his
milk	fish	zip

Trace the letter.

2
○

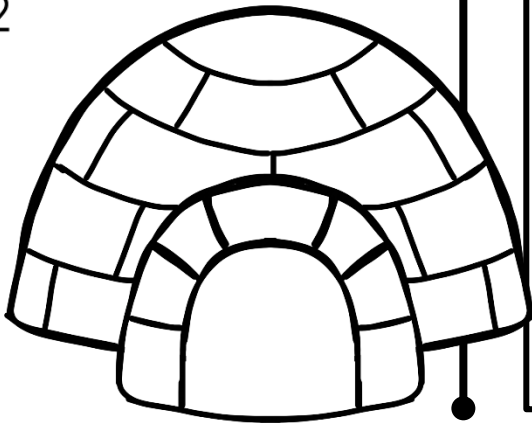

Circle all the "i" sounds.

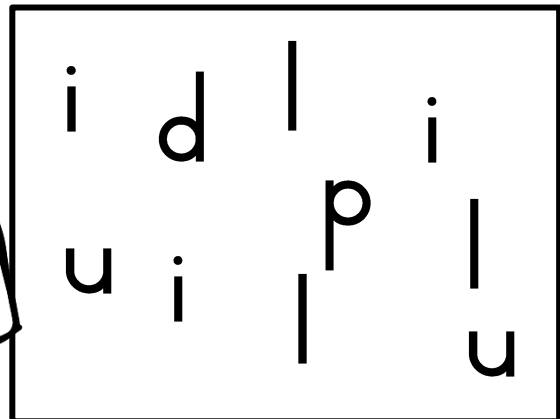

Practice writing the letter.

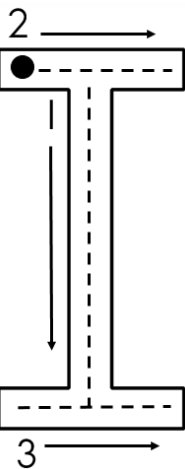
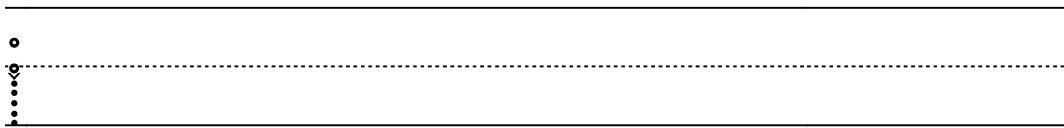

Complete the "i" sounds in the words.

__nsect

__nk

__gloo

__ce

Practice writing the capital letter.

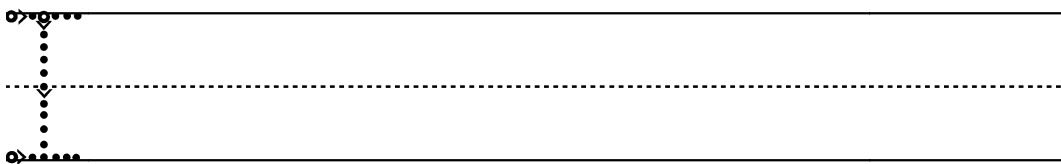

"i" sound

Colour all the pictures that start with the "i" sound.

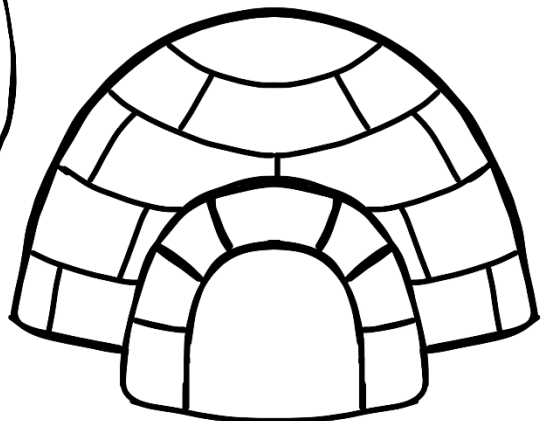
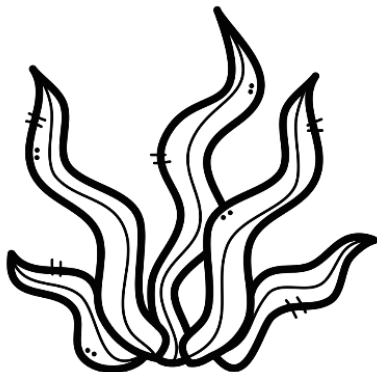
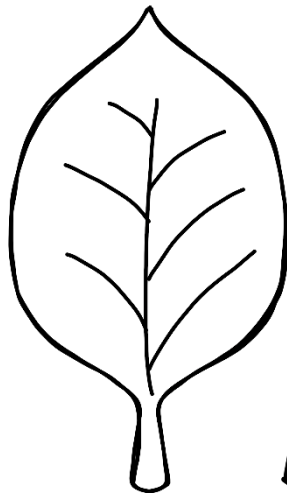
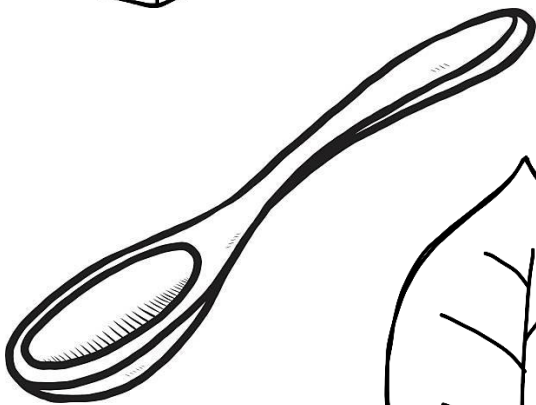
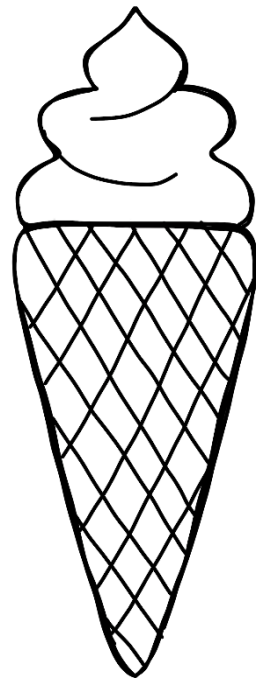
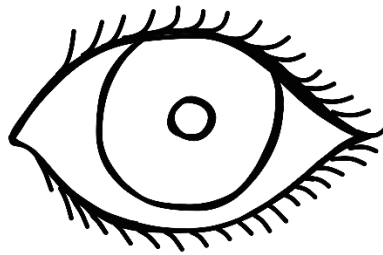
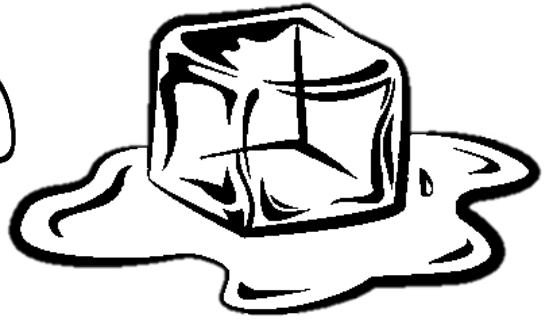
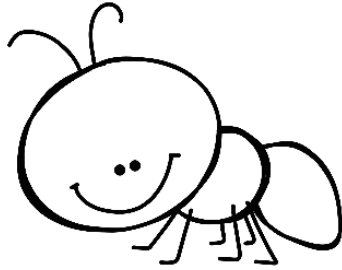

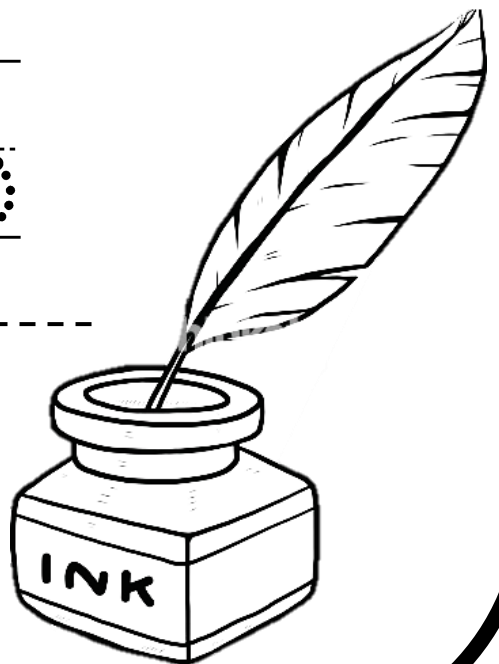
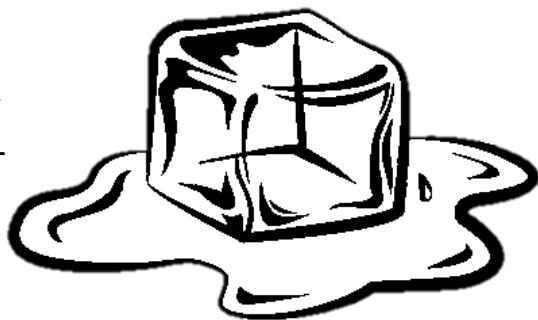
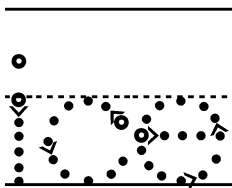
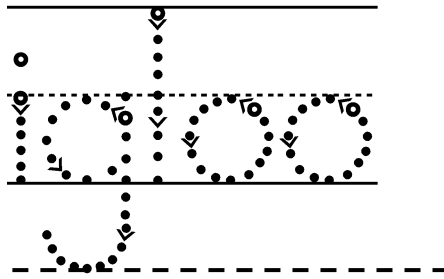
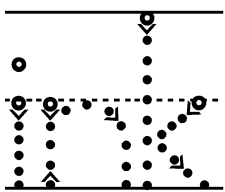
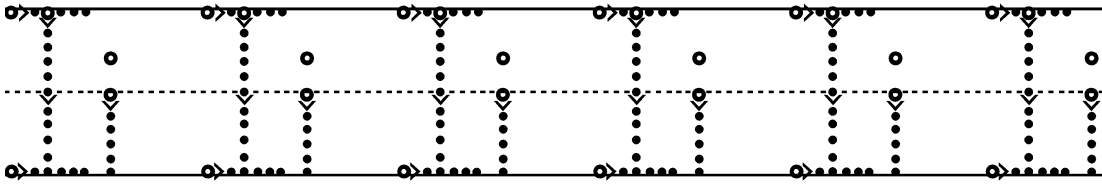
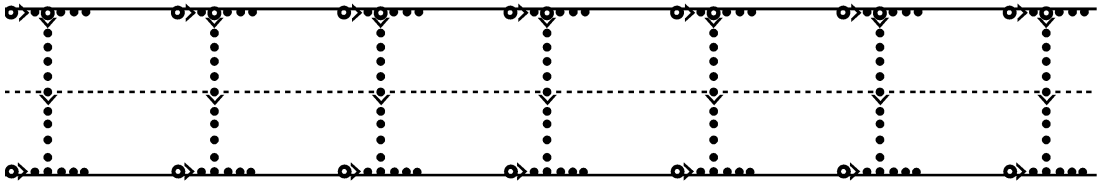
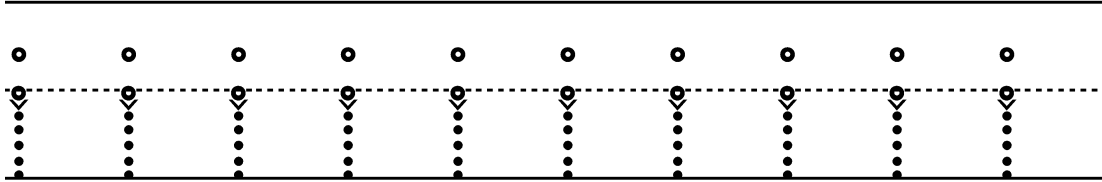
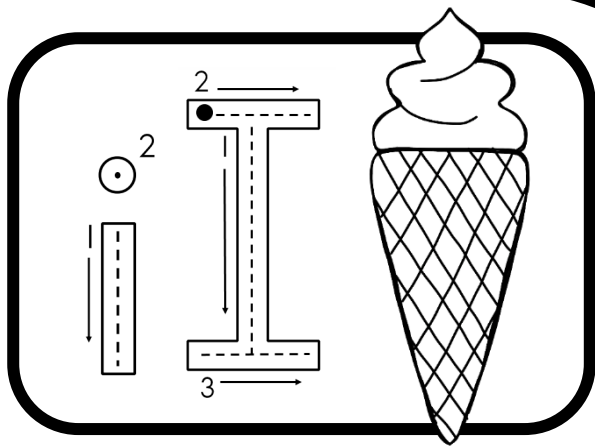

Colour the letter.

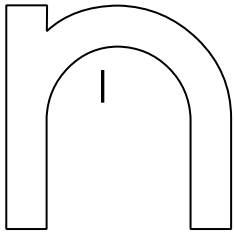

1 - grey

Read the words.

no	net	Ann
nap	nun	not

Trace the letter.

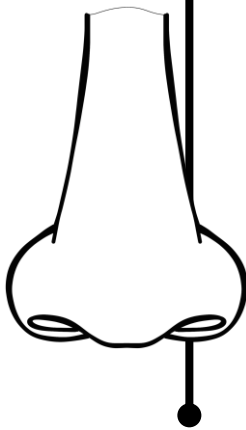
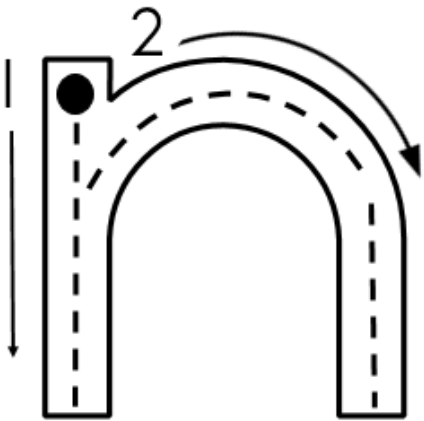

Circle all the "n" sounds.

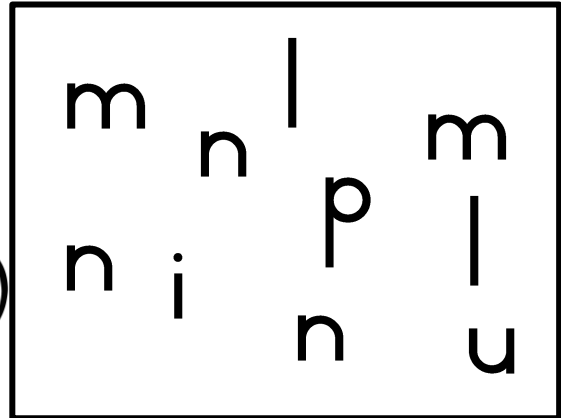

Practice writing the letter.

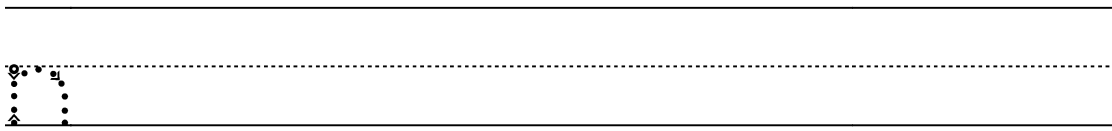

Complete the "n" sounds in the words.

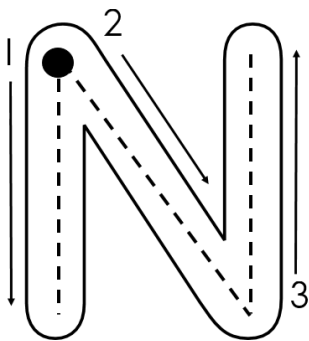

__et

__est

__ap

__urse

Practice writing the capital letter.

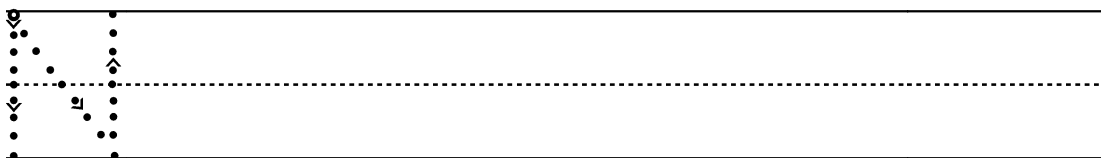

"n" sound

Colour all the pictures that start with the "n" sound.



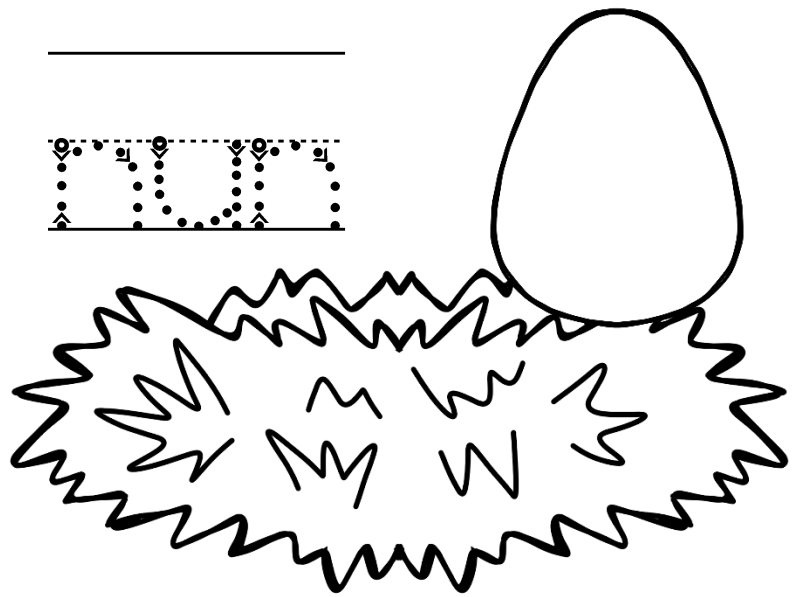
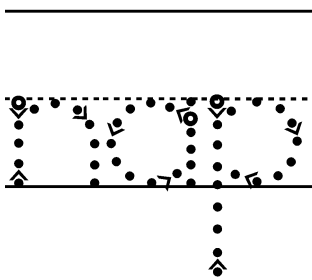
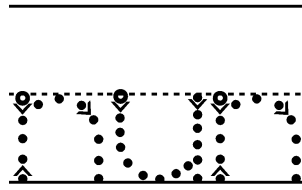
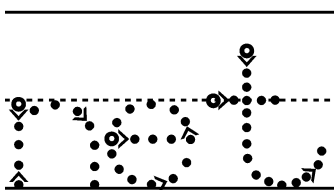
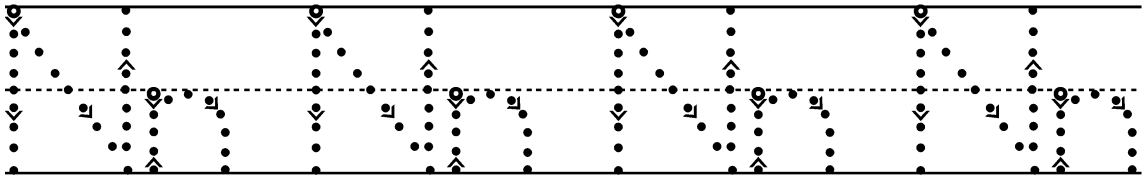
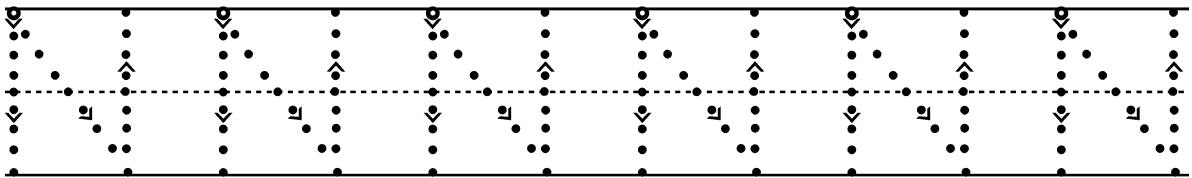
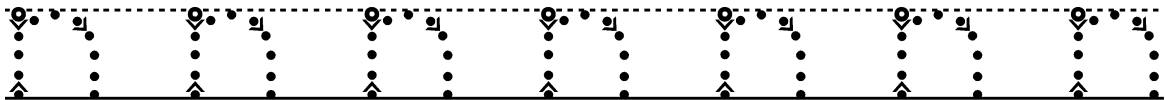
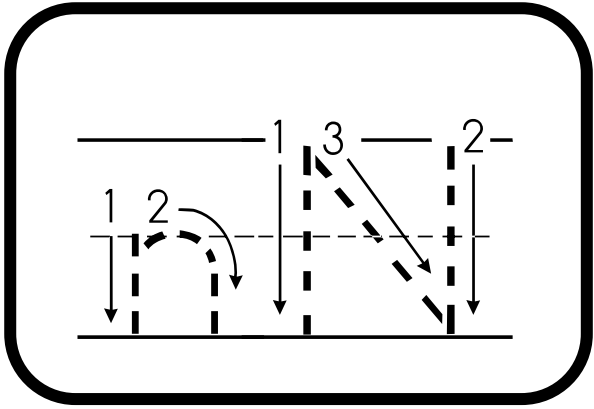

Colour the letter.

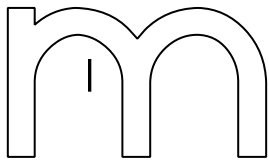

1 - purple

Read the words.

mom	mum	man
mad	my	Sam

Trace the letter.

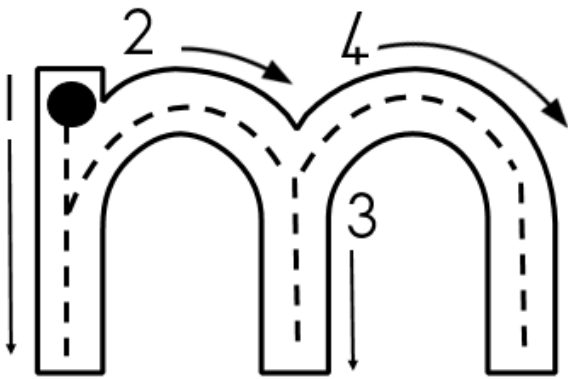

Circle all the "m" sounds.

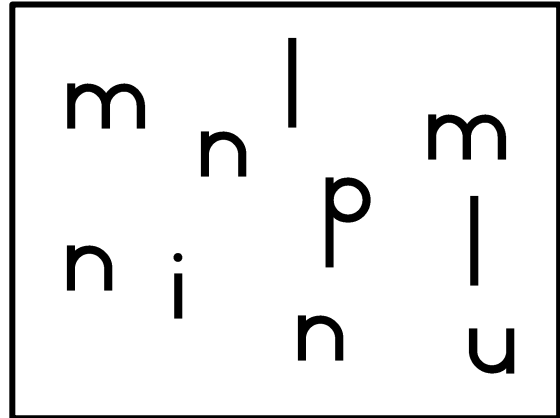

Practice writing the letter.

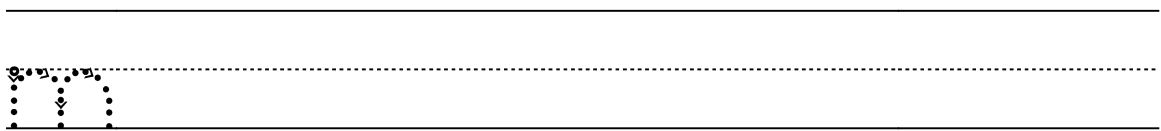

Complete the "m" sounds in the words.

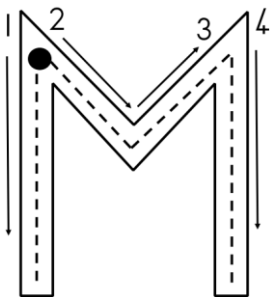

__y | __um | __onkey
Sa__ | __an | __ouse

Practice writing the capital letter.

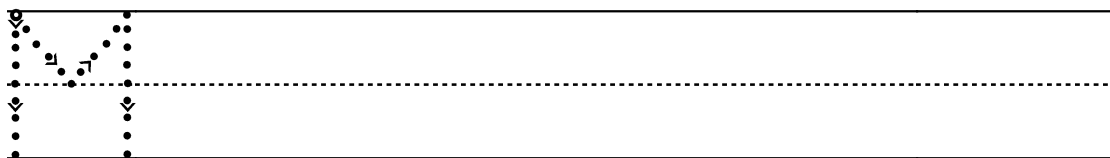

"m" sound

Colour all the pictures that start with the "m" sound.

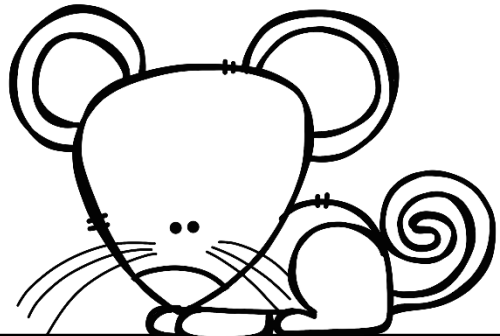
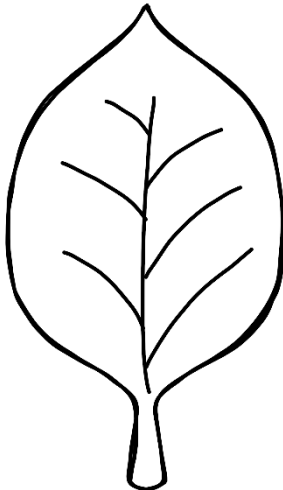
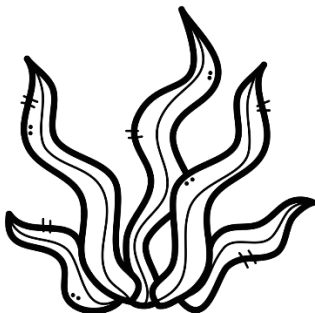
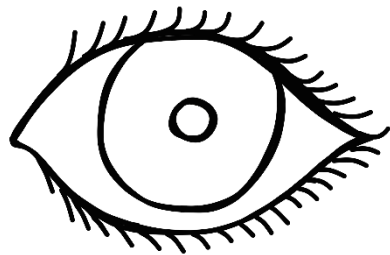
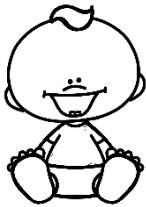
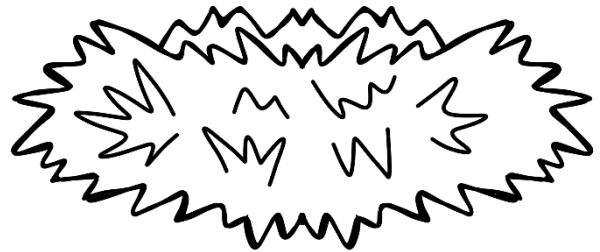
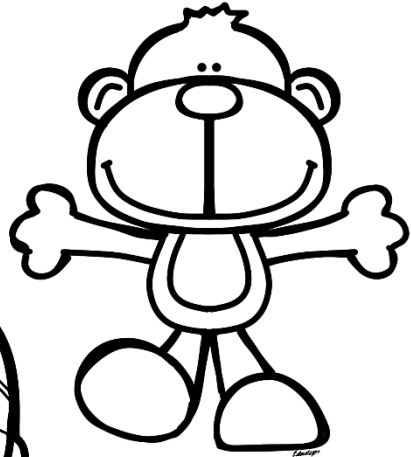
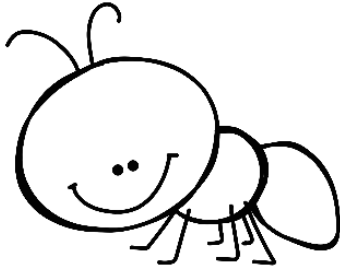
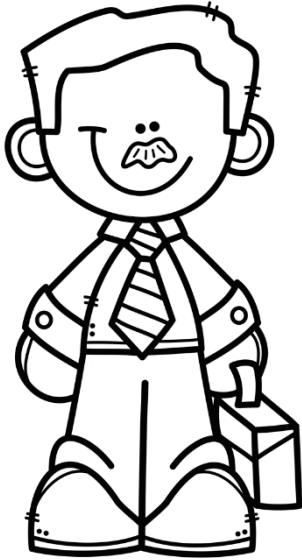

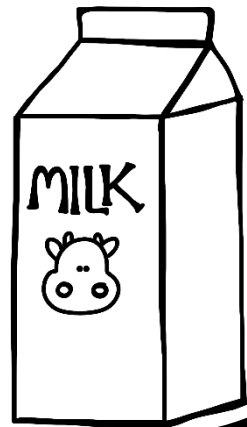
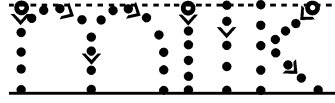
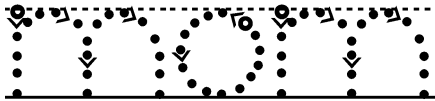
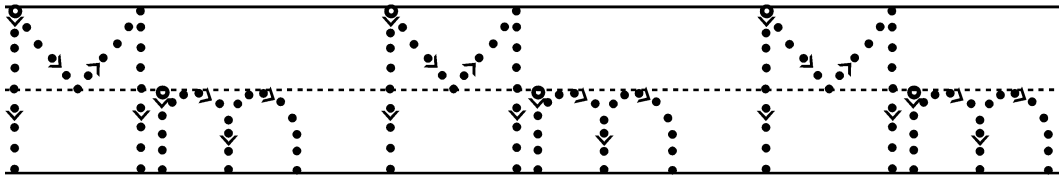
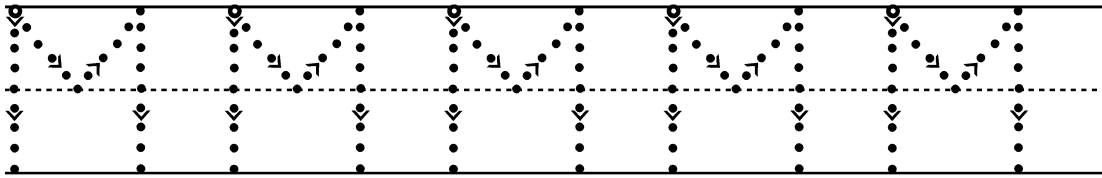
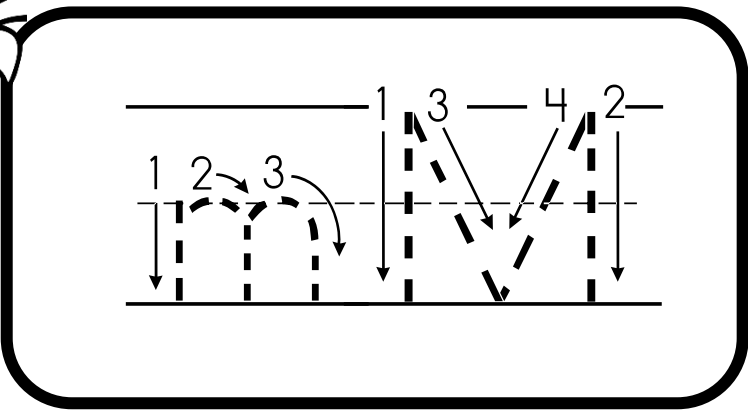
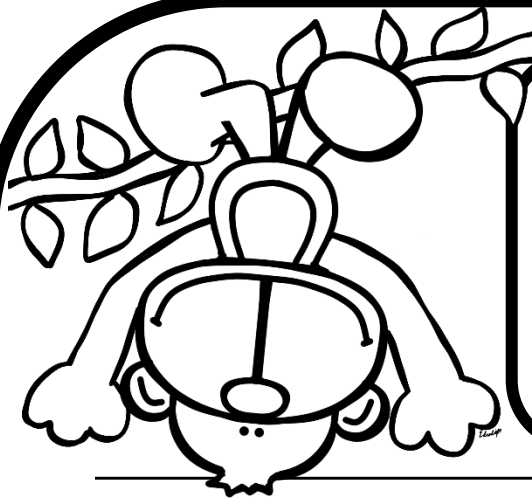

Colour the letter.

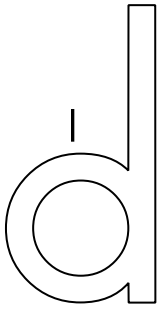

1 - blue

Read the words.

did	dad	duck
dog	dig	dug
desk	doll	door

Trace the letter.

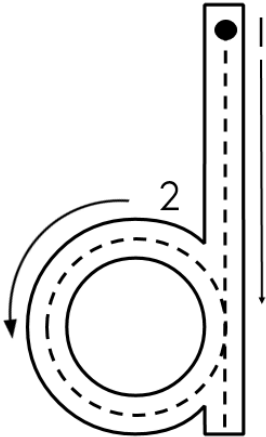

Circle all the "d" sounds.

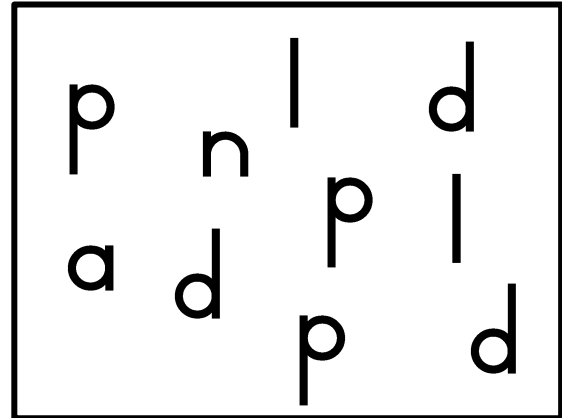

Practice writing the letter.

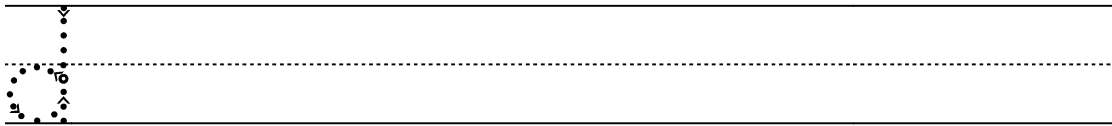

Complete the "d" sounds in the words.

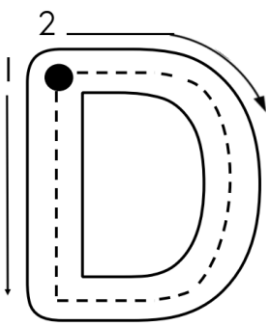

__og | __uck | __oll
__ig | __oor | __esk

Practice writing the capital letter.

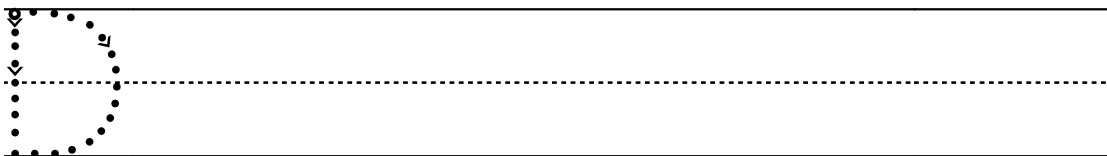

"d" sound

Colour all the pictures that start with the "d" sound.

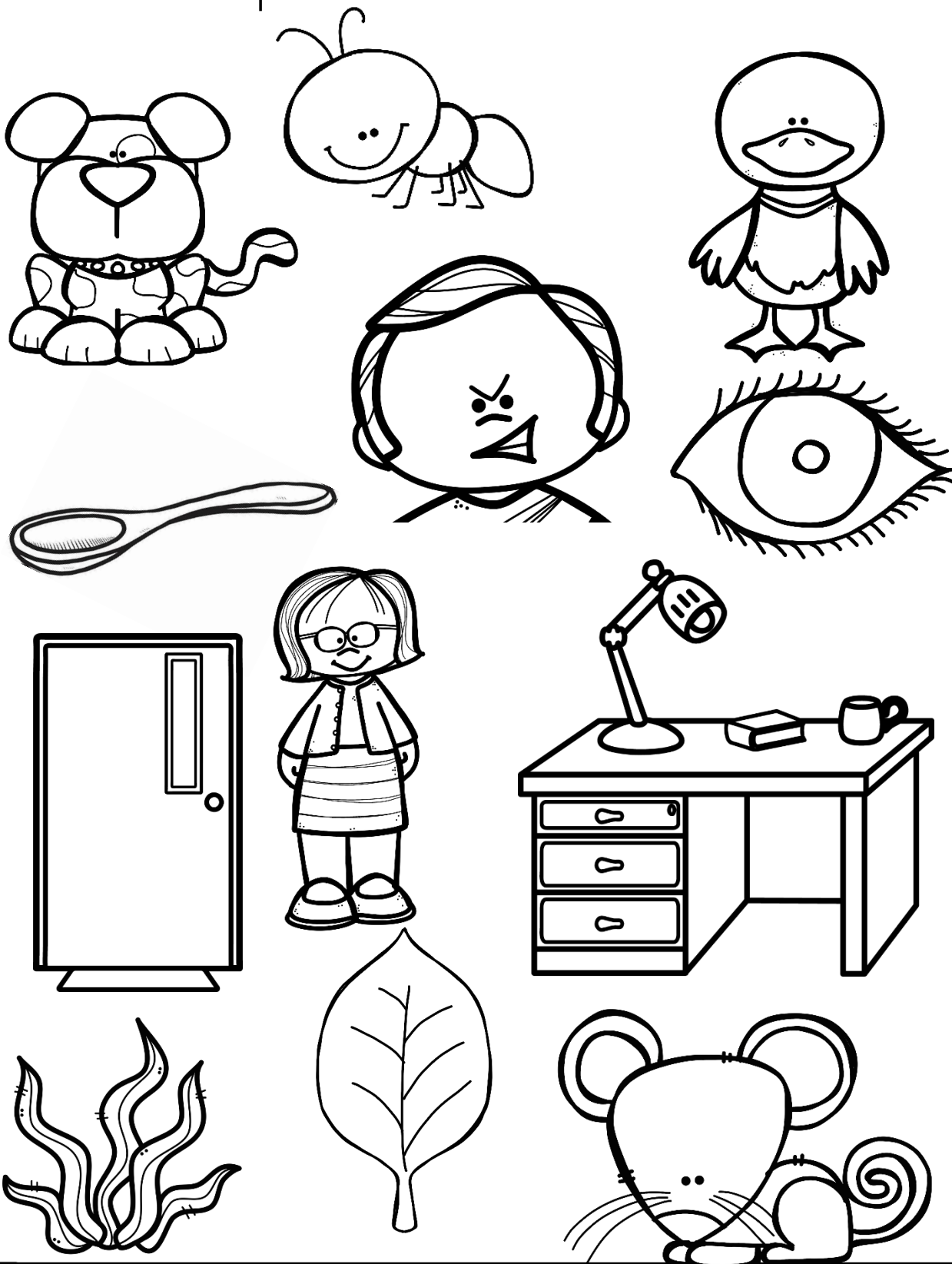

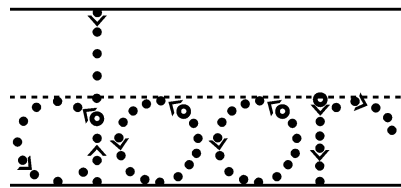
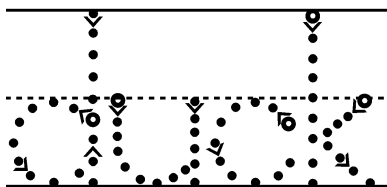
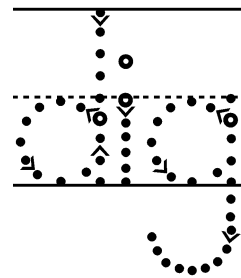
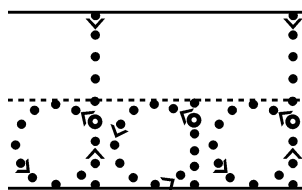
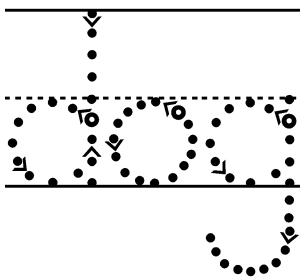
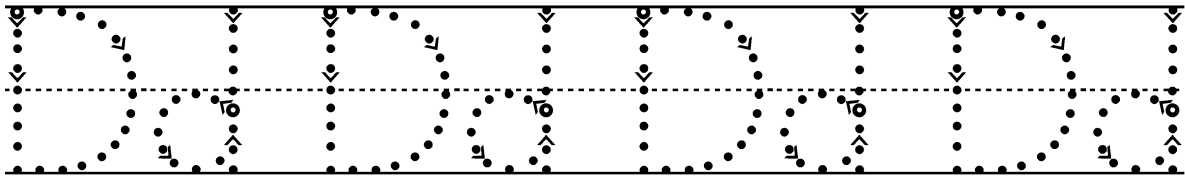
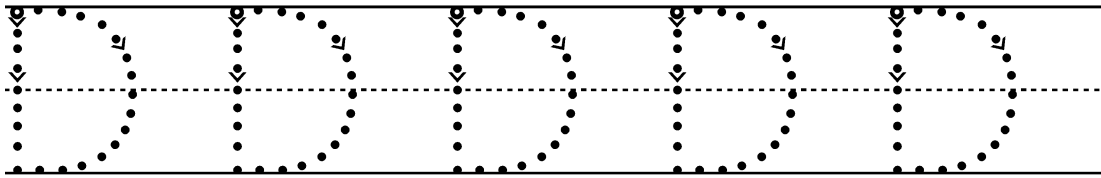
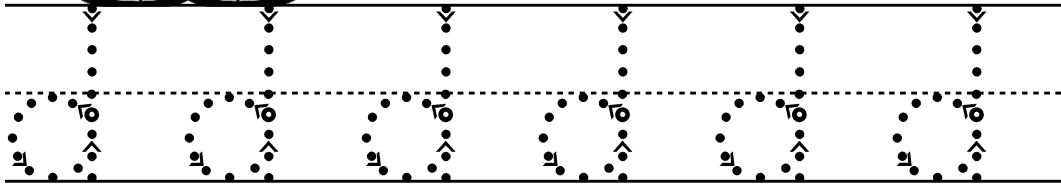
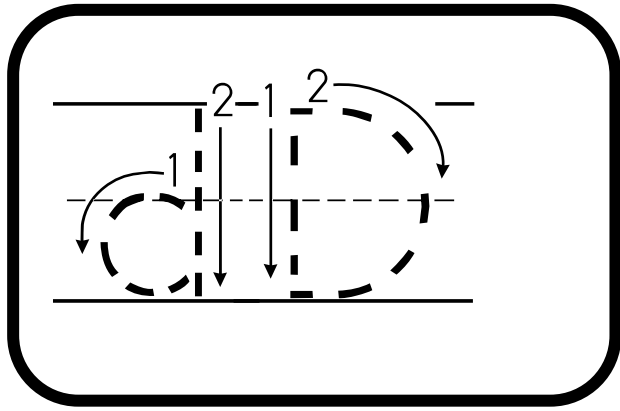
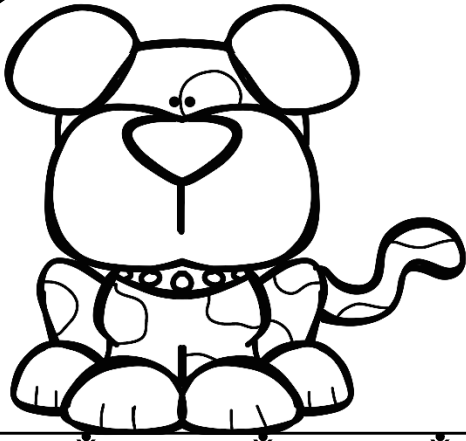

Colour the letter.

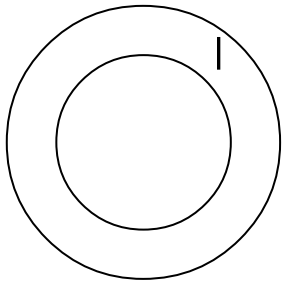

o - blue

Read the words.

hot	not	dog
top	on	fox
doll	box	sock

Trace the letter.

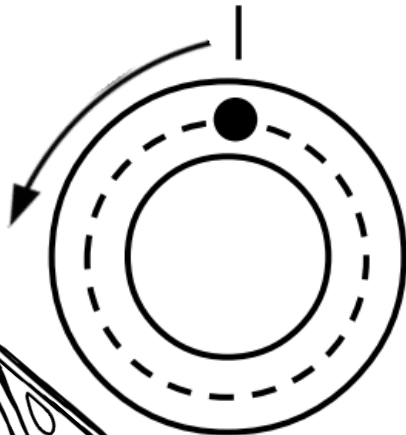

Circle the "o" letters.

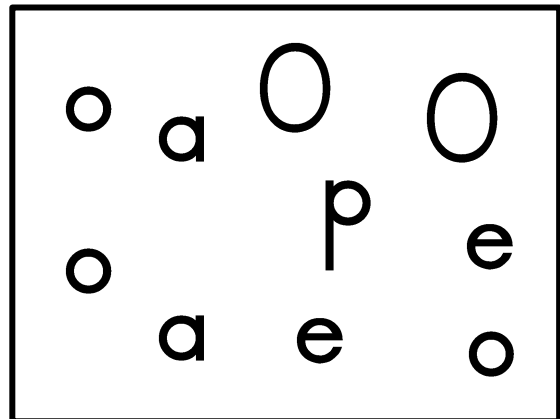

Practice writing the letter.

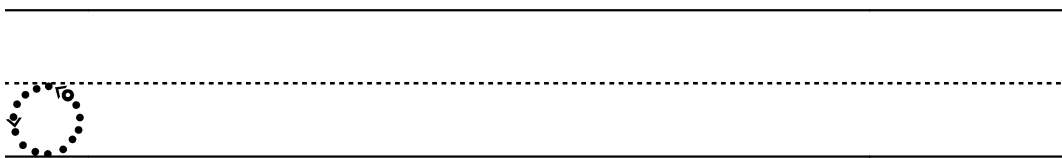

Complete the "o" sound in the words.

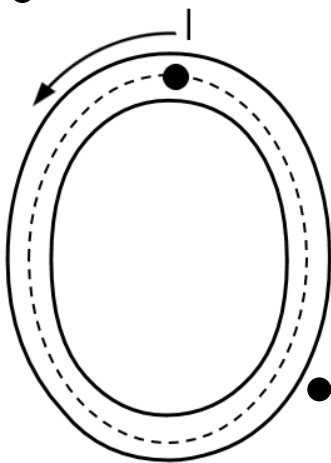

__range

d__ts

s__cks

__ctopus

Practice writing the capital letter.

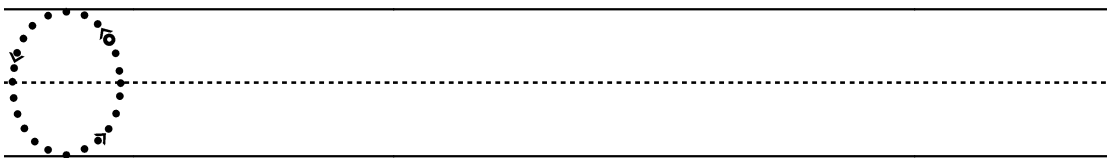

"o" sound

Colour all the pictures that start with the "o" sound.

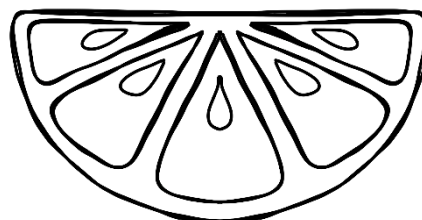
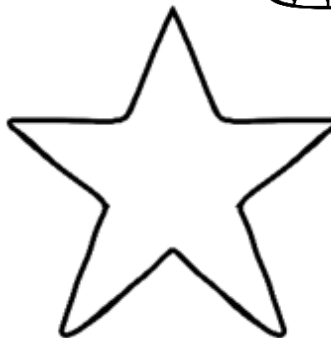
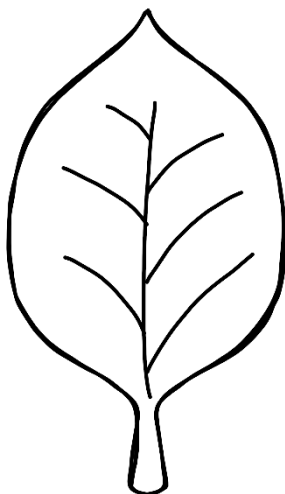
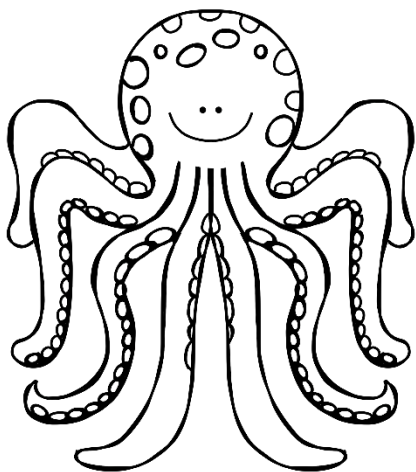
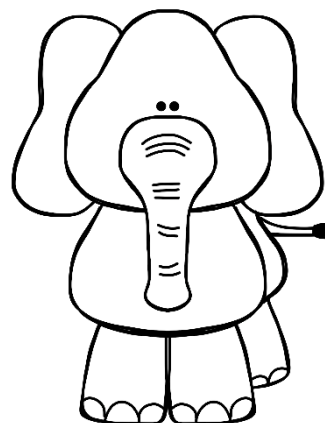
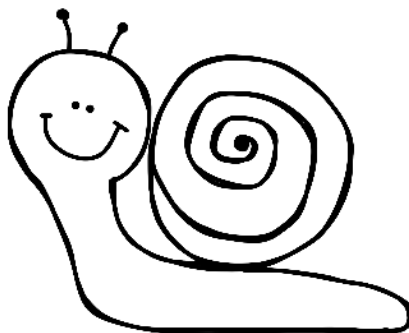
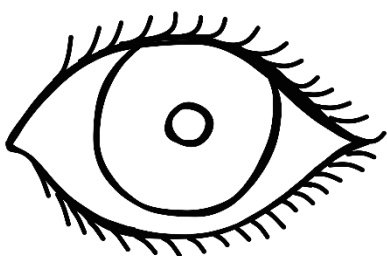
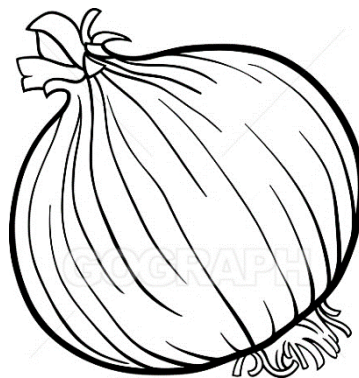
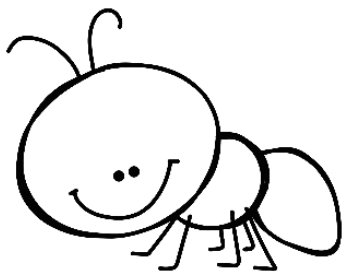

Complete the words.

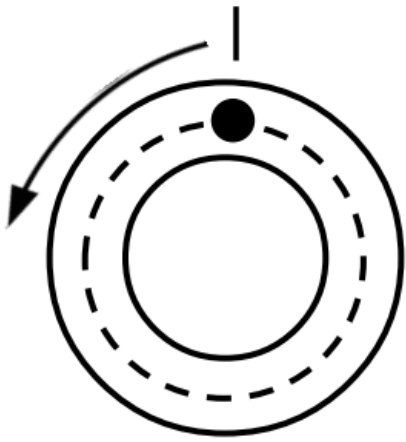

b__x	f__x	h__t
d__ts	s__cks	d__g
n__t	t__p	d__ll

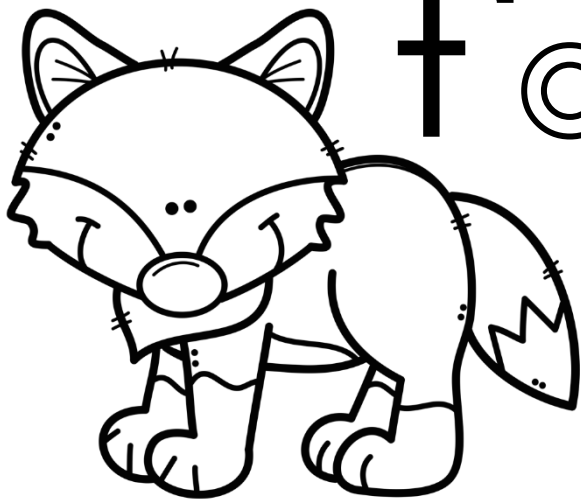

fox

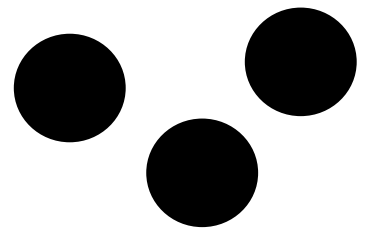

dots



socks

box

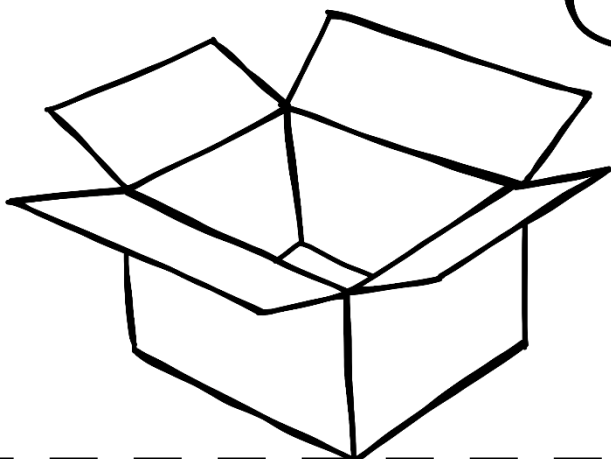

hot



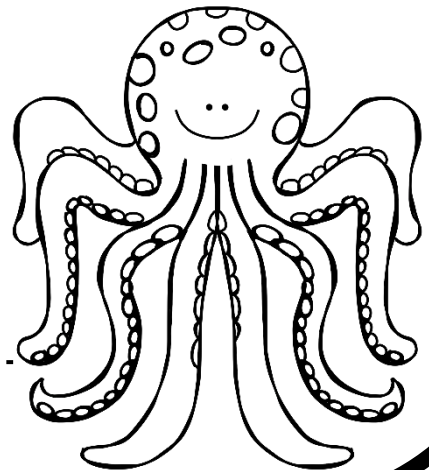
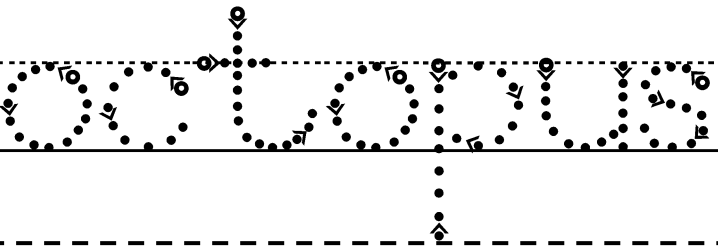
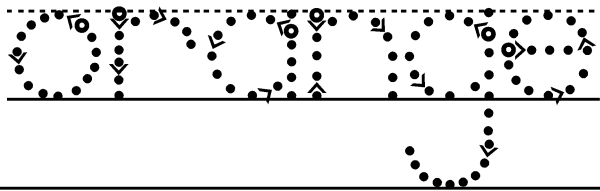
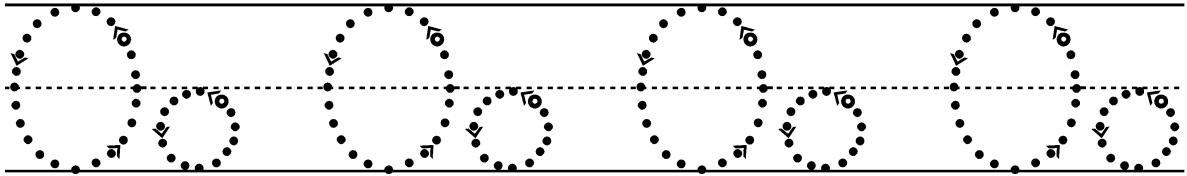
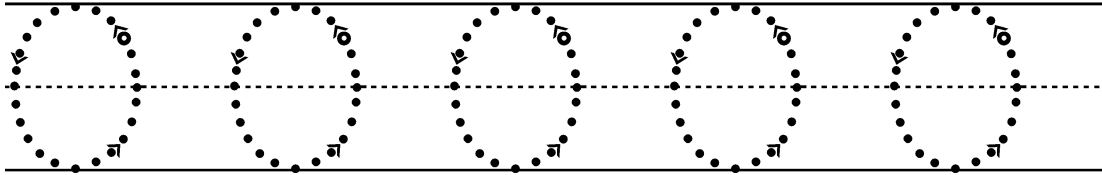
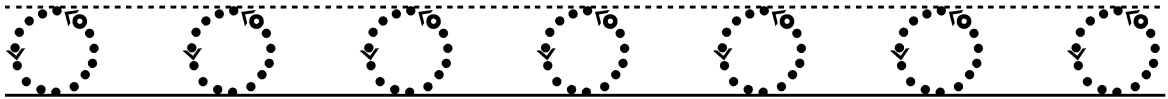
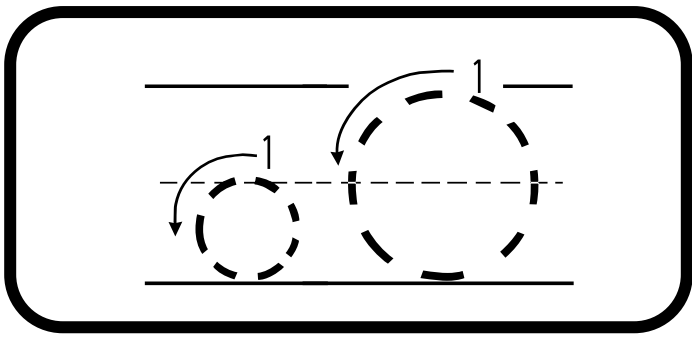

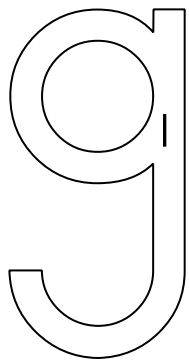

Colour the letter.

l - green

Read the words.

get	got	gum	go
mug	jug	bug	rug

Trace the letter.

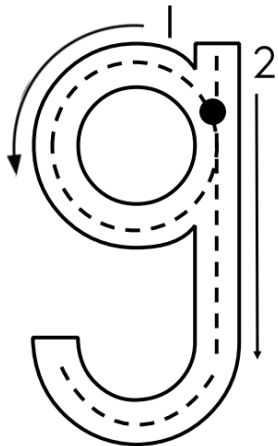
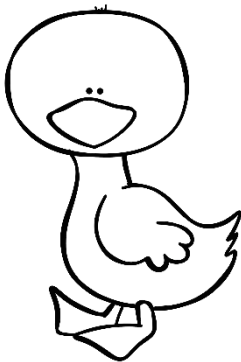

Circle the "g" sound.

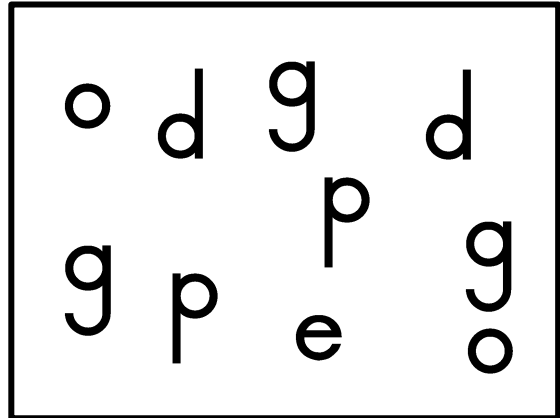

Practice writing the letter.

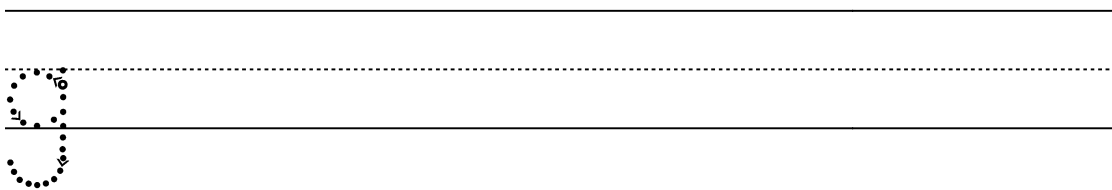

Complete the "g" sound in the words.

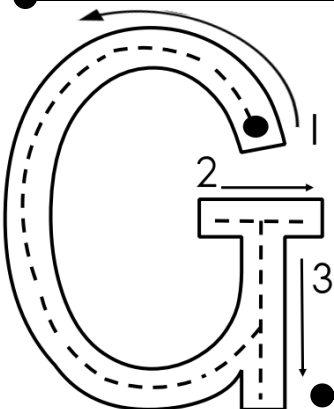

__ oat | __ ate
 __ rass | __ lass

Practice writing the capital letter.

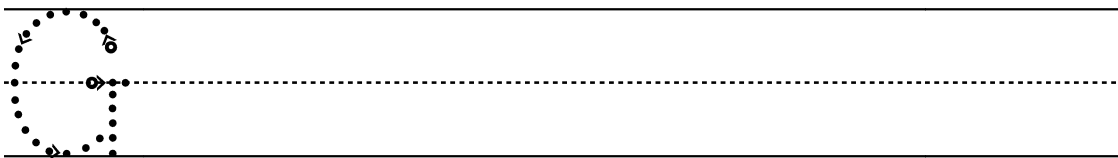

"g" sound

Colour all the pictures that start with the "g" sound.

