

Grade /  
English  
First Additional Language

Term /



h h h

h h h h h

o o

o o o o o

A A

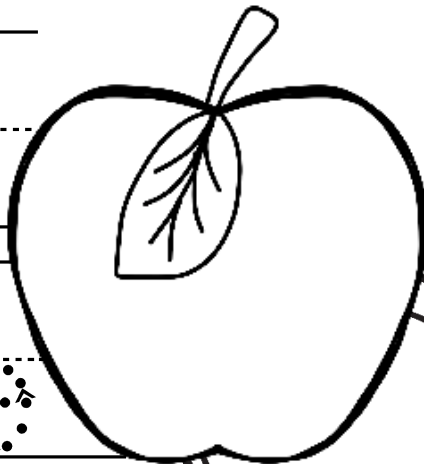

a a a

Name:

My name is:

\_\_\_\_\_

-----

\_\_\_\_\_

Draw the candles on the cake to show how old you are.

The first letter of my name is:

A J D B  
G L O I E  
Q F C K H  
U M S N P  
Z X V W Y  
T R

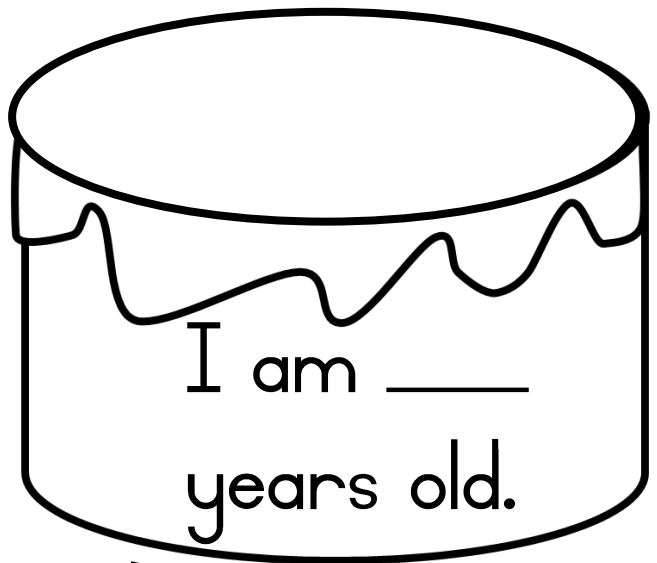

My favourite colour is:

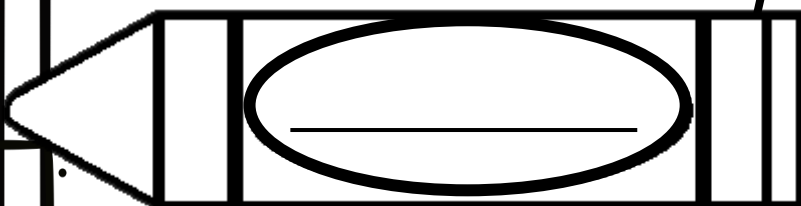

My fingerprint



# My family

sister

brother

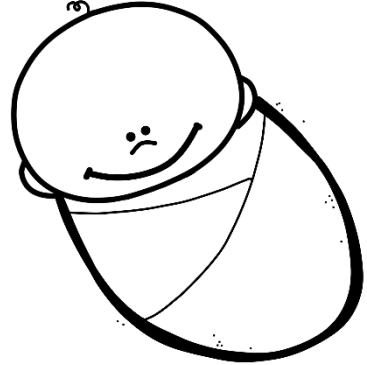
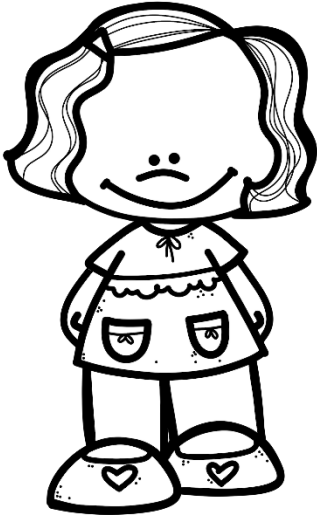

baby

mother

grandmother

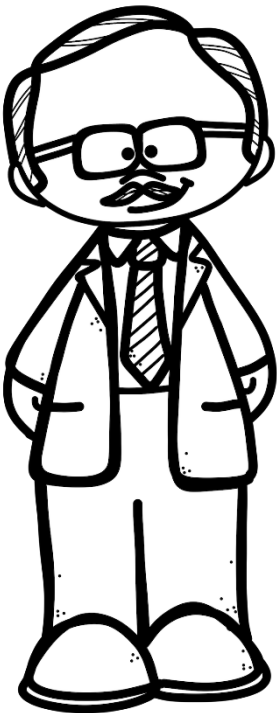

father

grandfather

# My family

Draw a picture of your family.

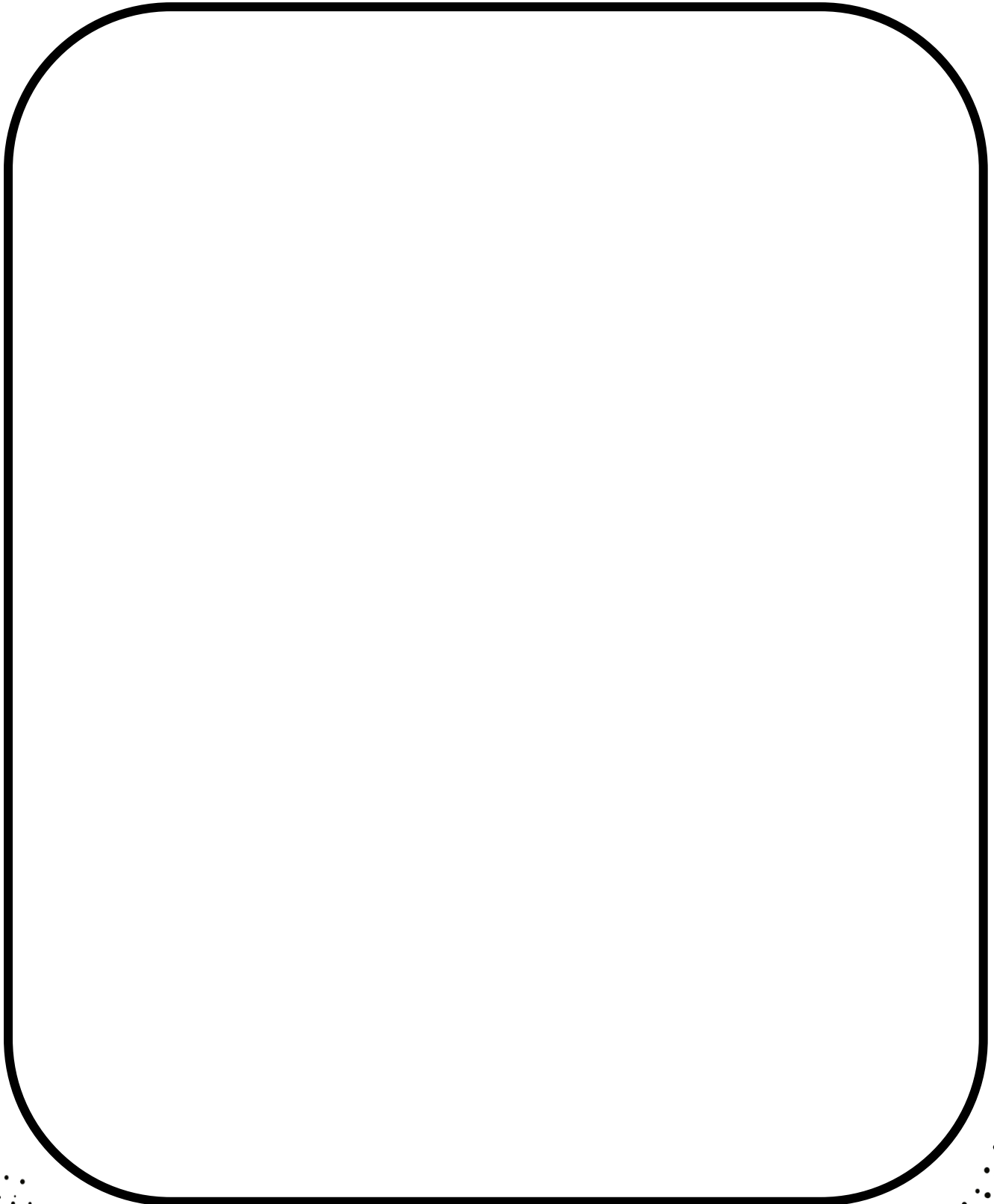

# My body

hair

head

eyes

arms

legs

stomach

big

toes

foot

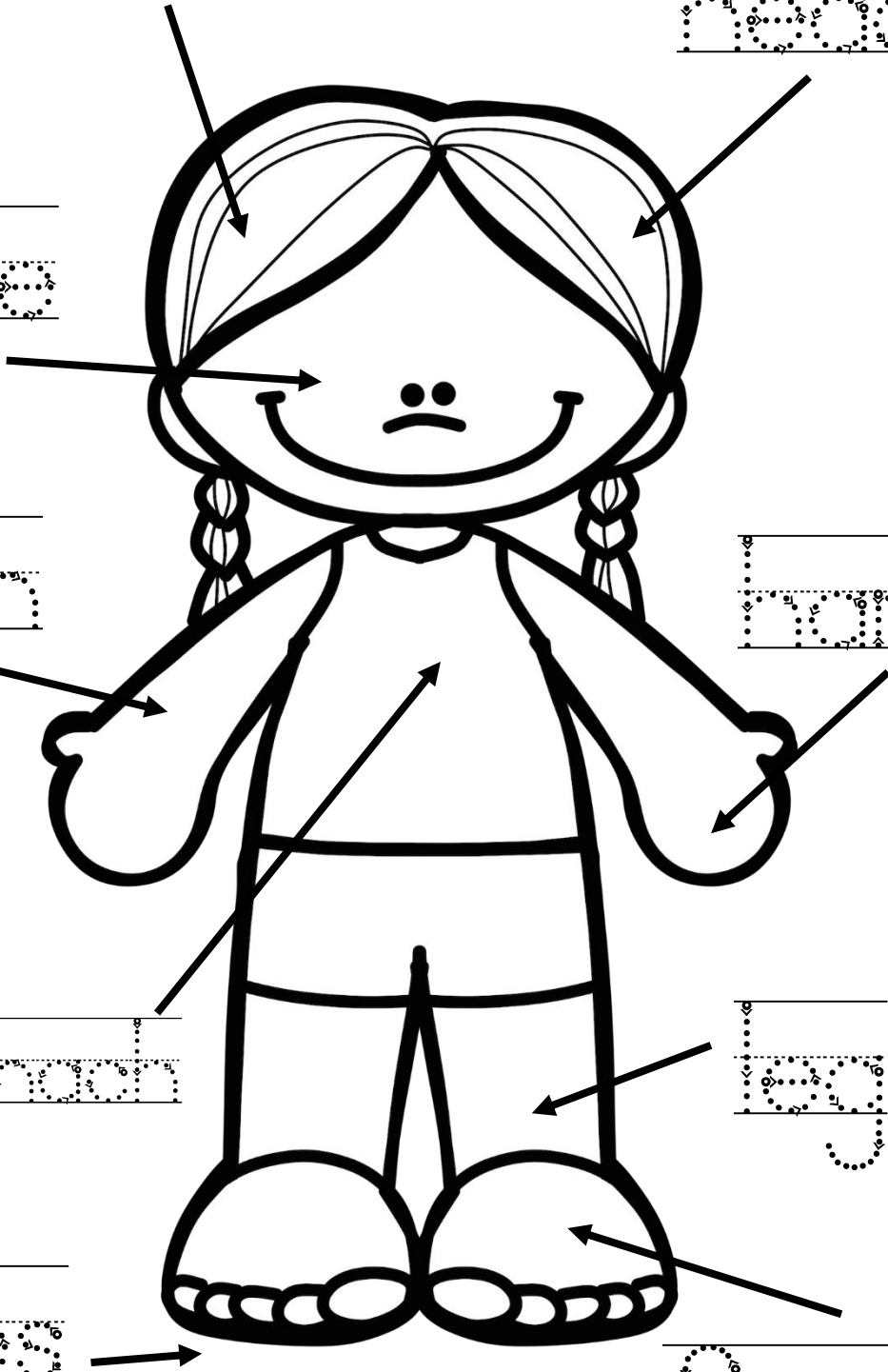

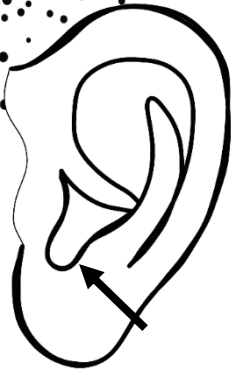

ear

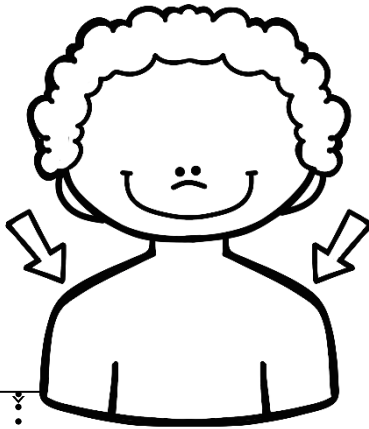

shoulders

foot

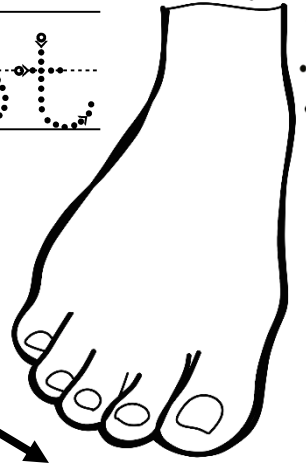

toes

finger



thumb

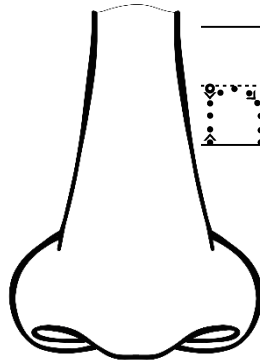

nose

arm

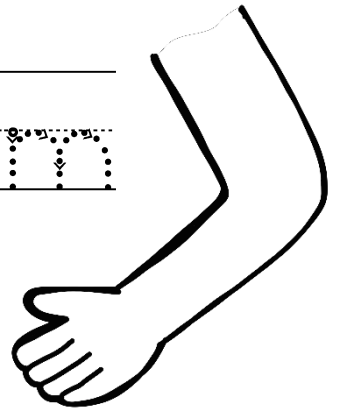

eye

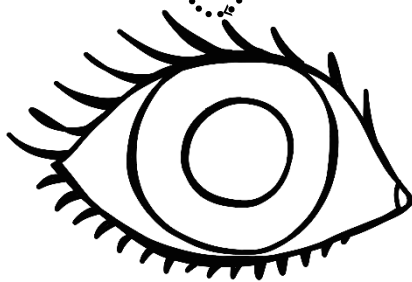

tooth

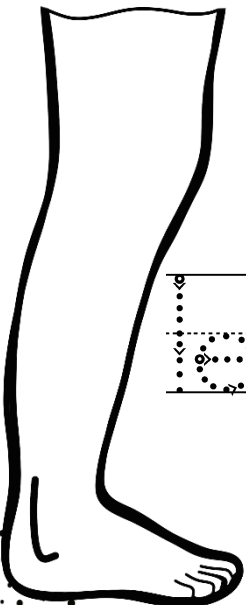

leg

mouth

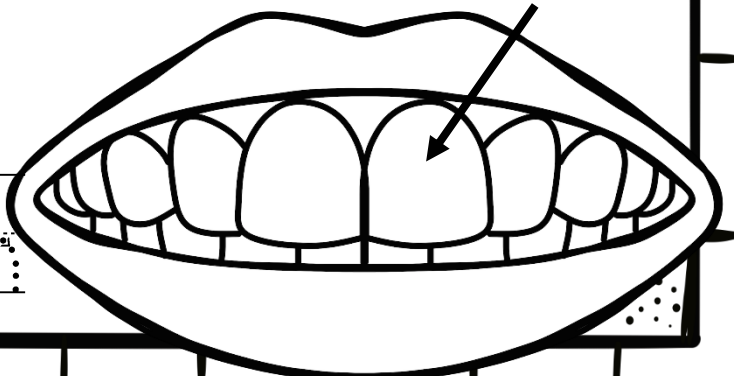

# Numbers 1 to 10

1

one

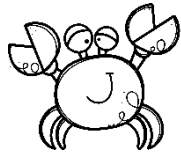

2

two

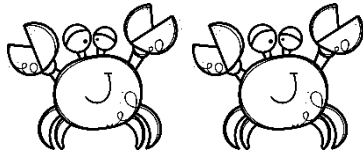

3

three

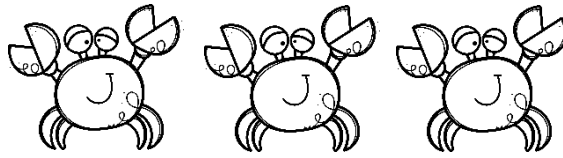

4

four

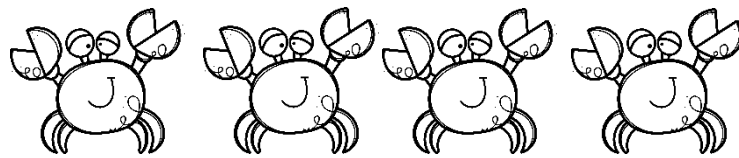

5

five



6

six



7

seven



8

eight



9

nine



10

ten



Complete the numbers in the sea stars.

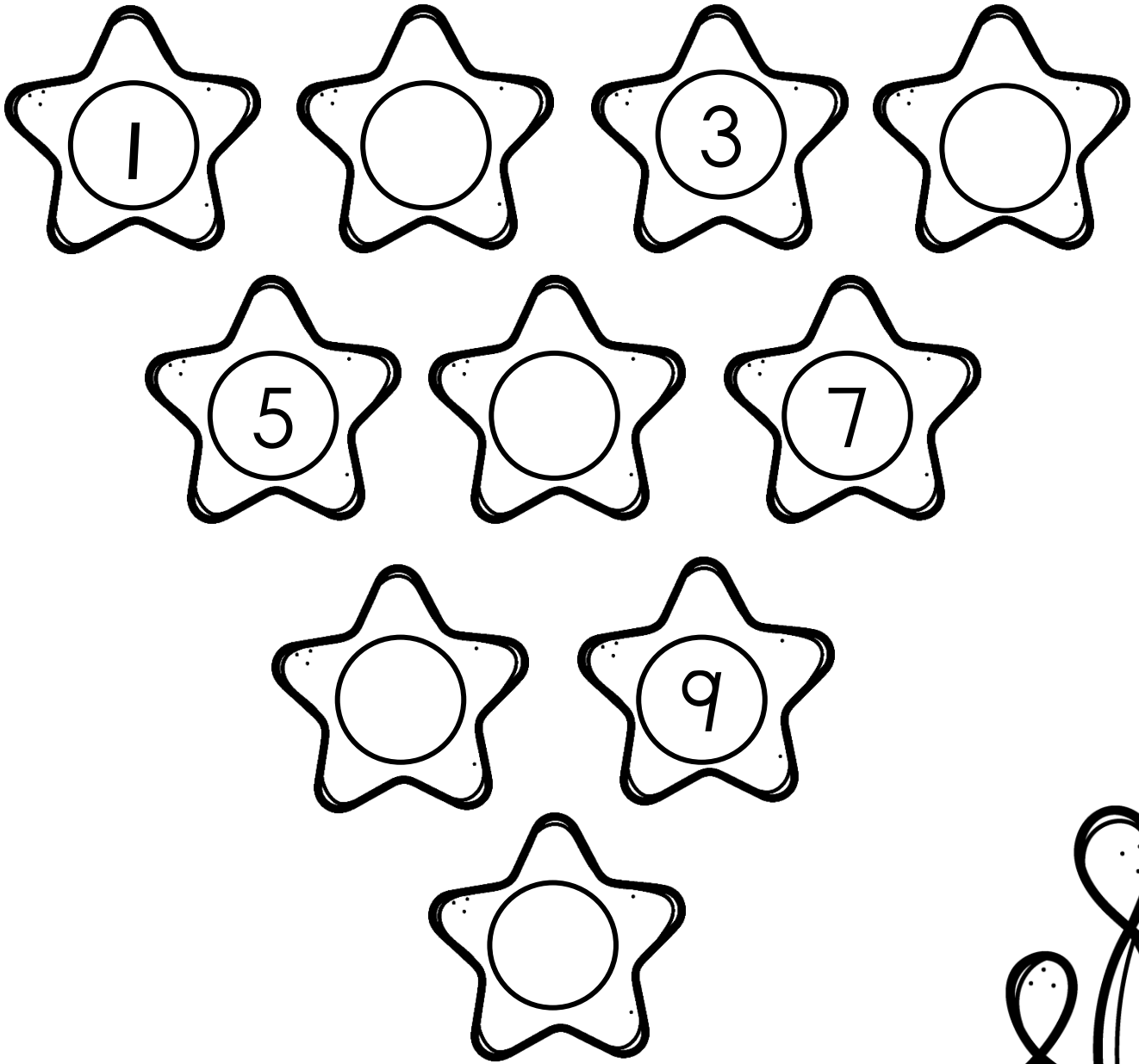

Practice the words.

|     |       |       |      |      |
|-----|-------|-------|------|------|
| one | two   | three | four | five |
| six | seven | eight | nine | ten  |

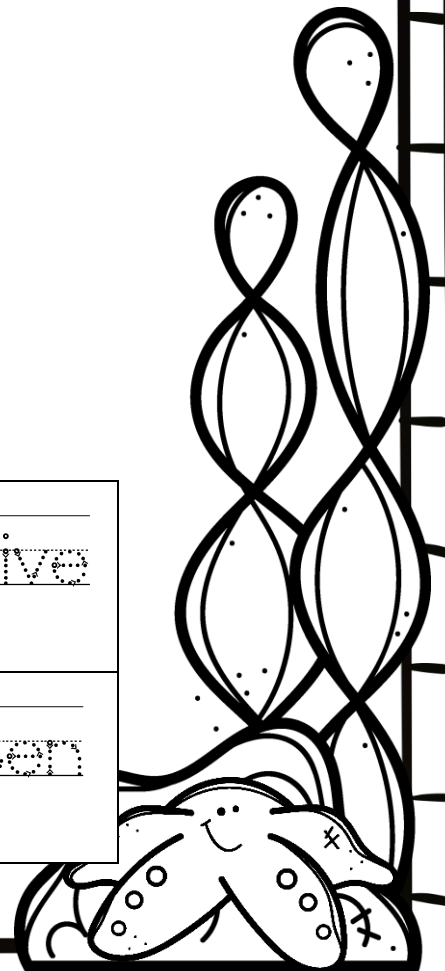



Match the number with the correct amount of pictures by drawing a line.

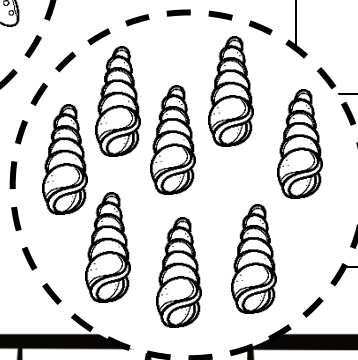
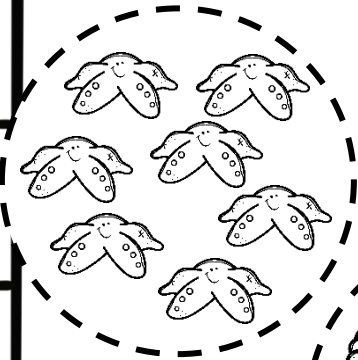
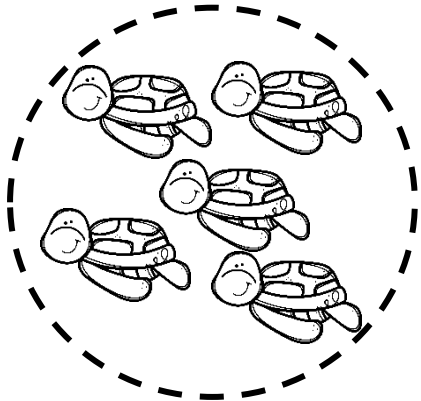
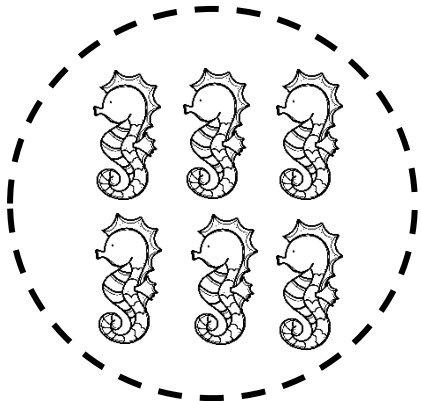
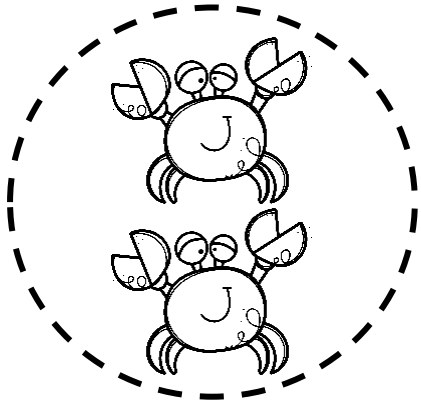

|    |
|----|
| 1  |
| 2  |
| 3  |
| 4  |
| 5  |
| 6  |
| 7  |
| 8  |
| 9  |
| 10 |

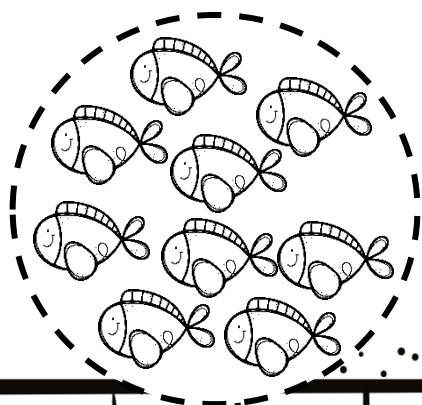
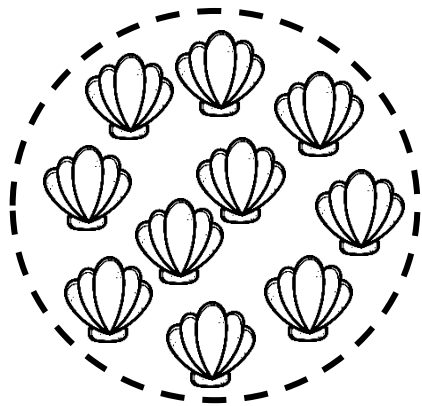
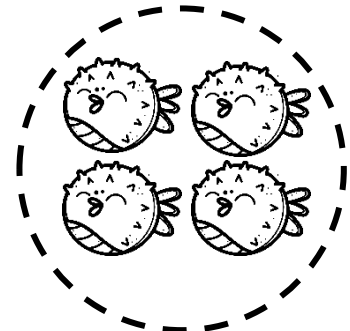
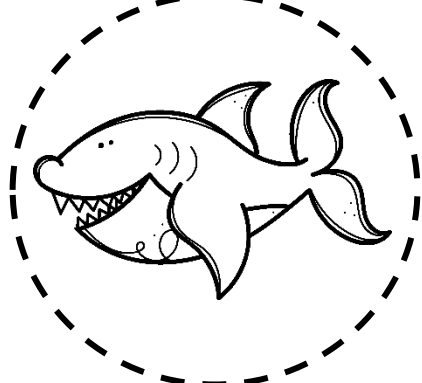
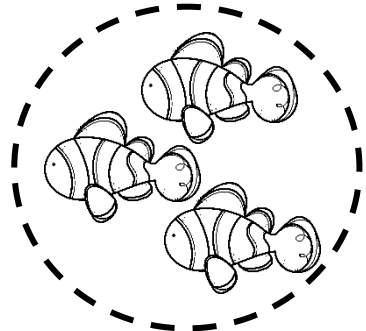

Trace and read the words.  
Colour the pictures the correct colour.

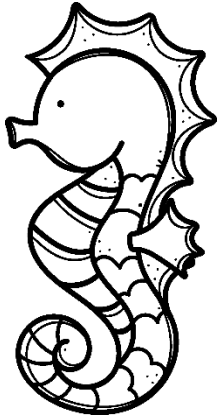

seahorse

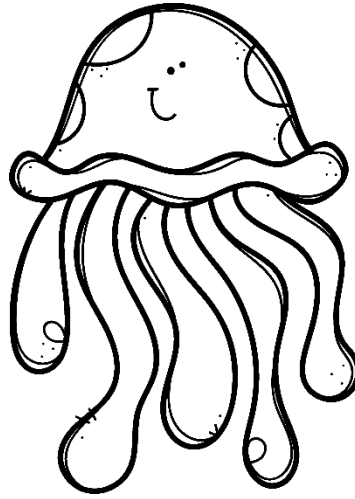

jellyfish

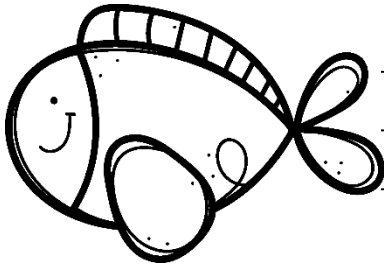

clownfish



pufferfish

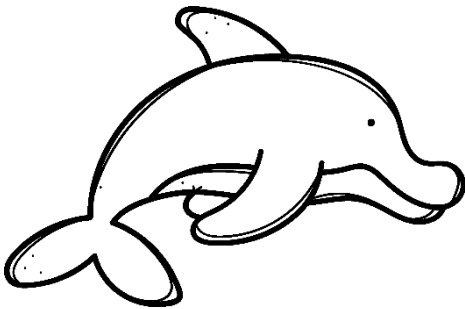

dolphin

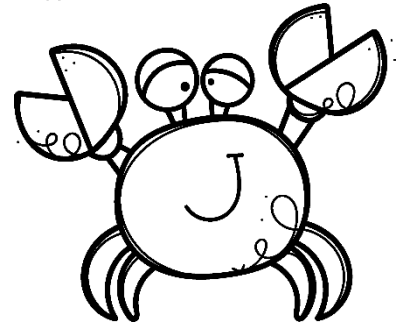

crab

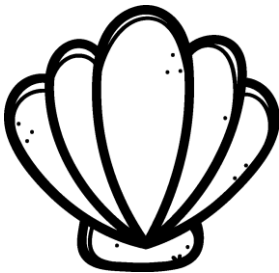

seashell



squid

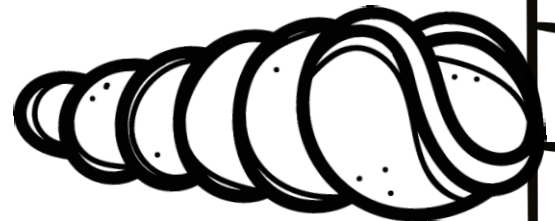

nautilus

# Insect fun

Help the insects to get to the flower.

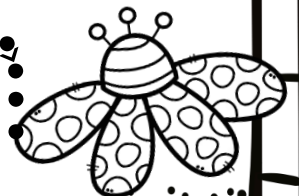
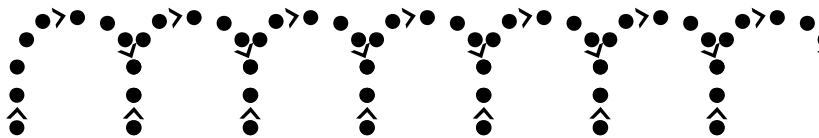
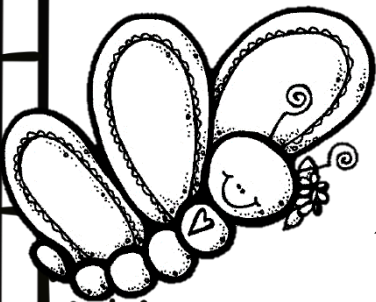
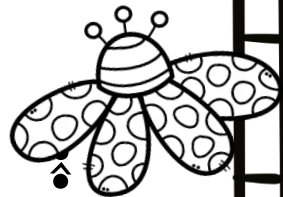
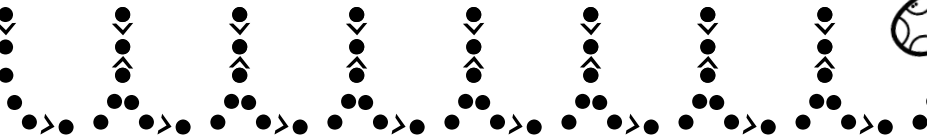
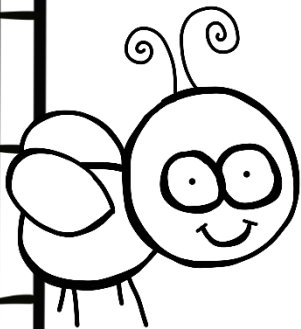
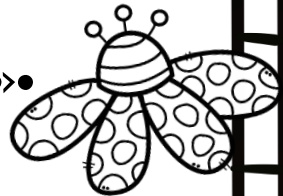
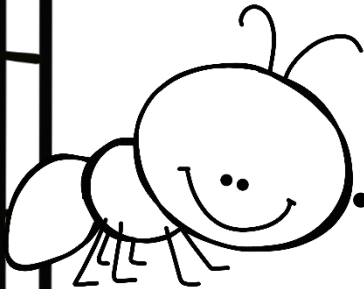
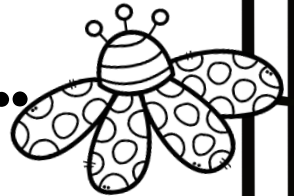
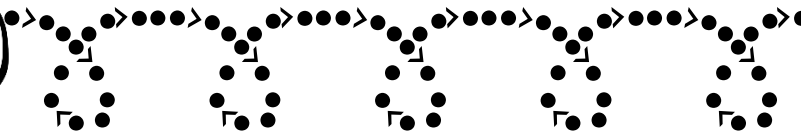
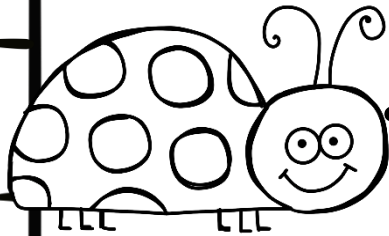
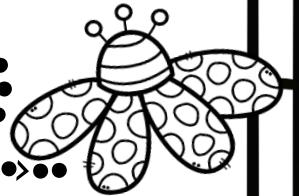
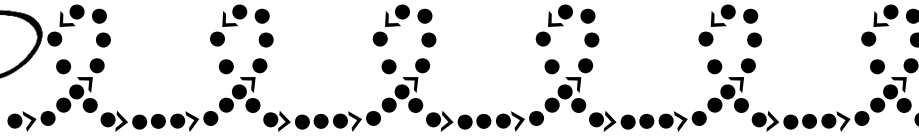
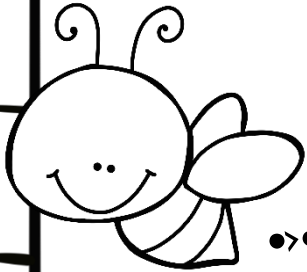



Hop like a rabbit to reach the carrot.

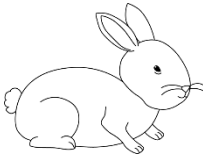
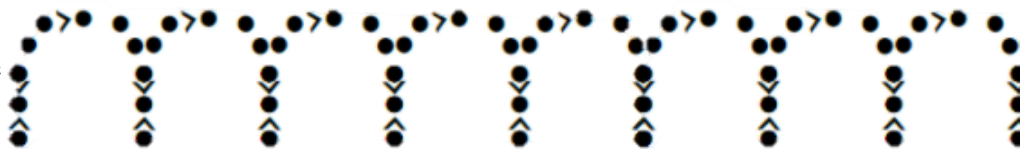
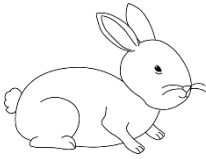
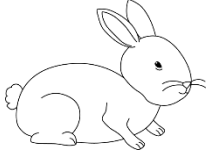

Hop like a frog.

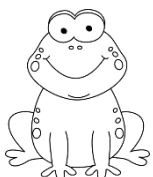
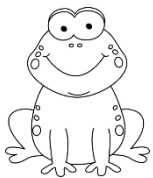
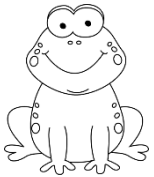
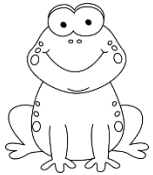



Swim like a dolphin  
over the waves.

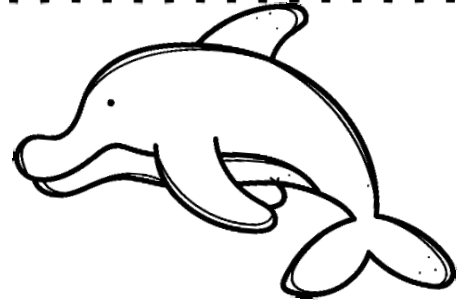

---

Complete the rest of the line with waves.



Gallop like a horse.



---

Complete the rest of the line.

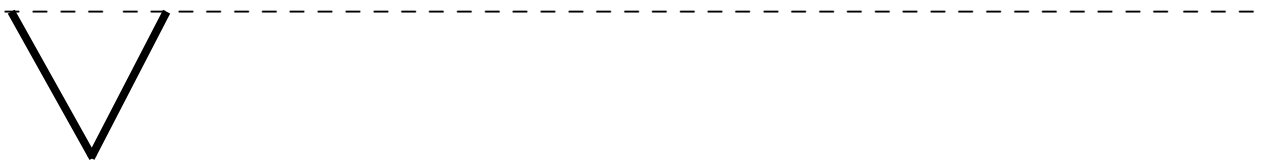

# Monkey swing

Show the monkey how to swing by completing the pattern.

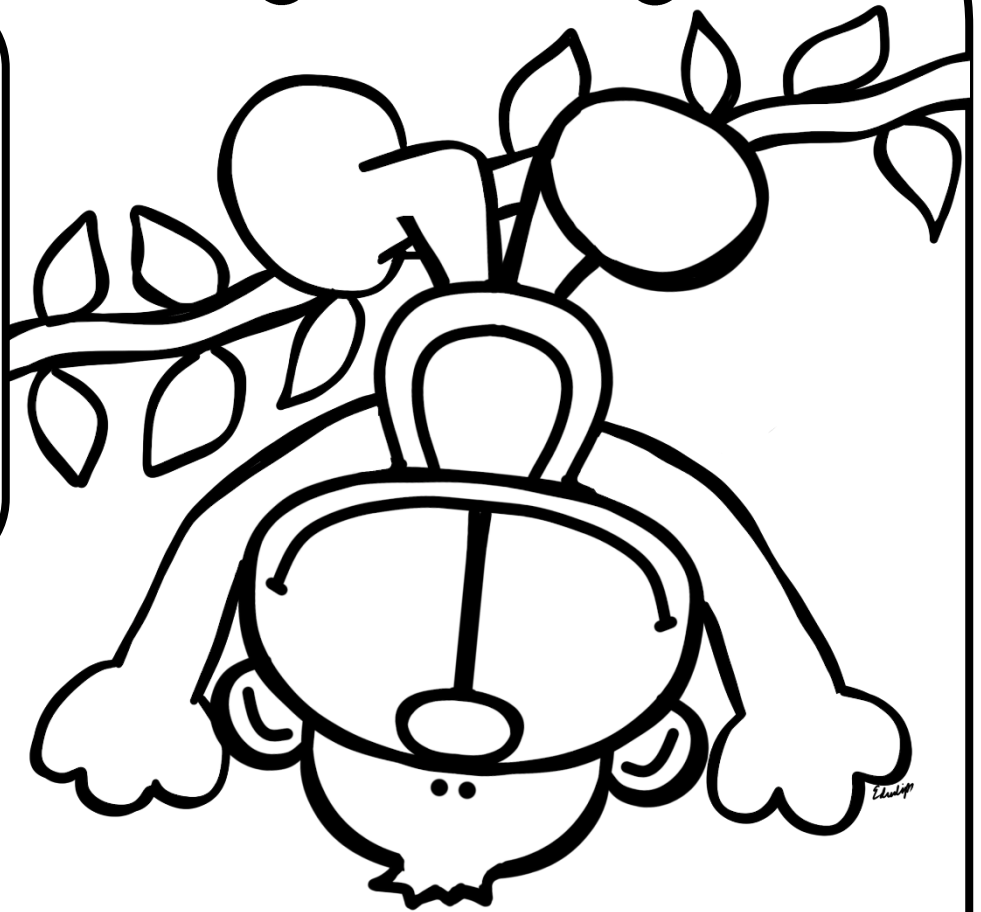

Swing with Tarzan  
through the woods.





Colour the pictures that begins with the sound.

a

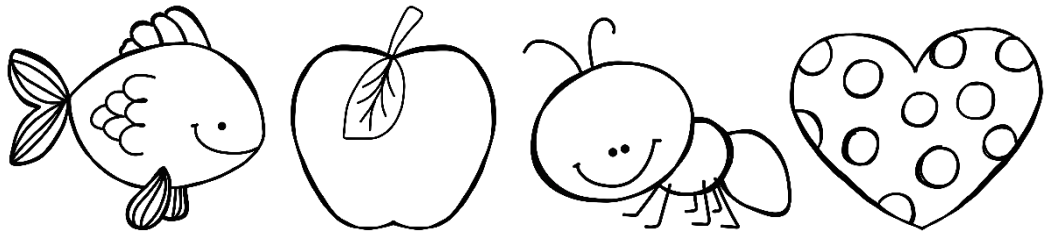

s

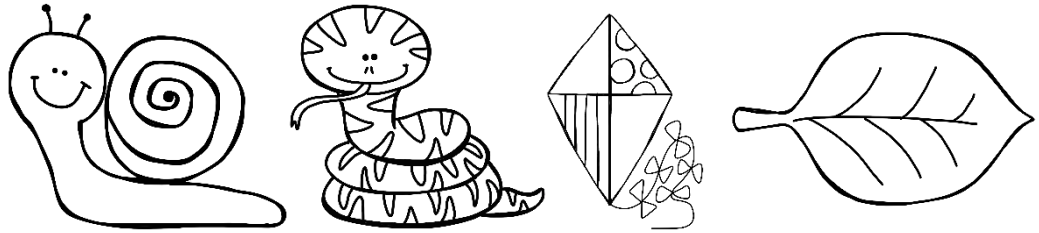

b

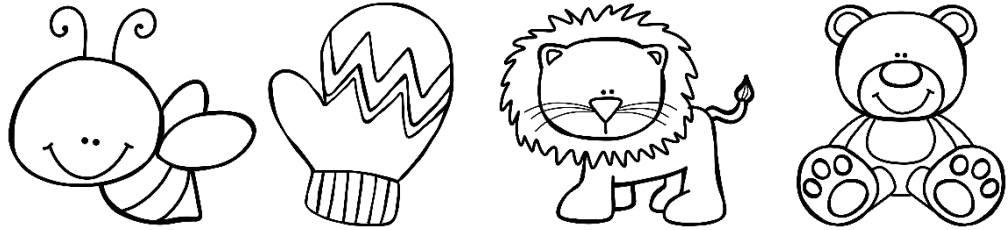

m

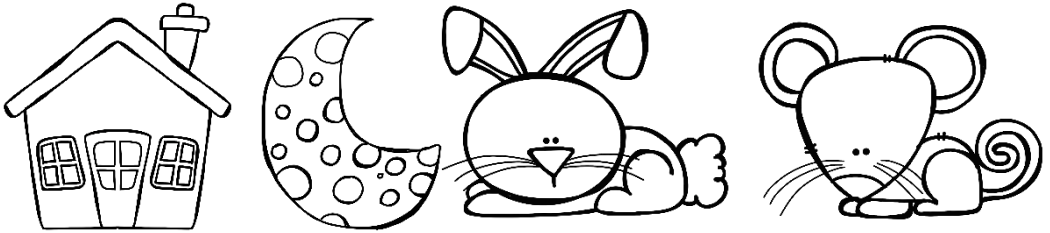

k

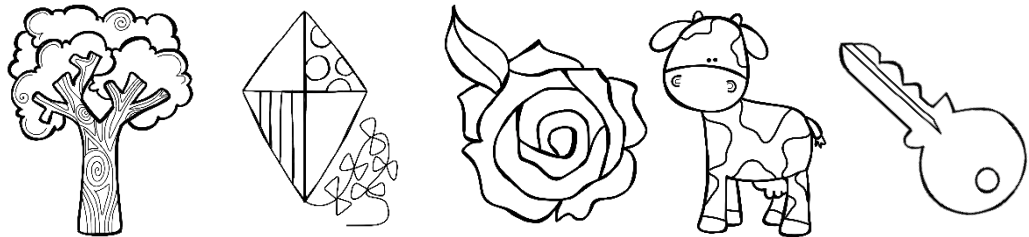

e

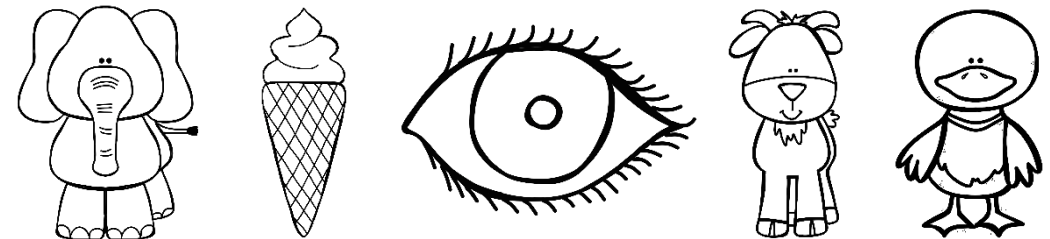

a

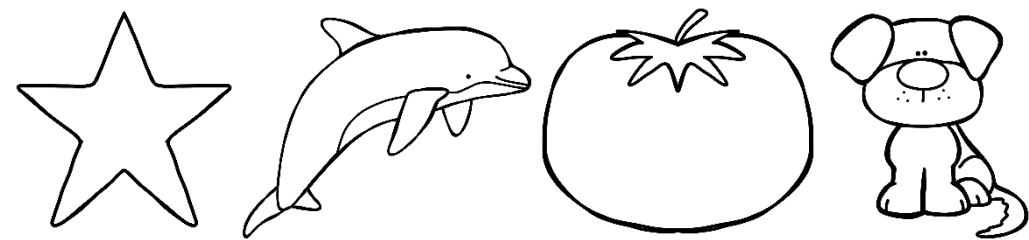

# Beginning sound

With which letter do the following words begin?

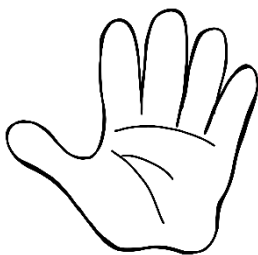
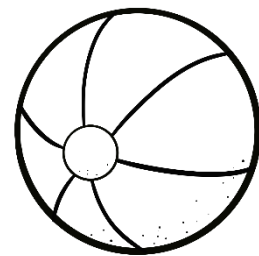
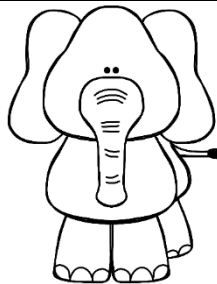
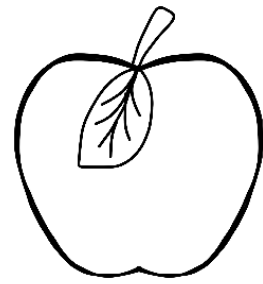
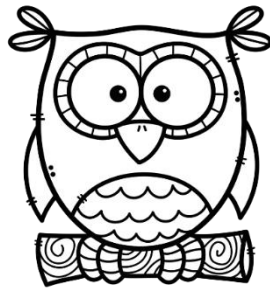
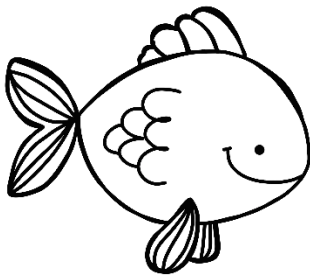
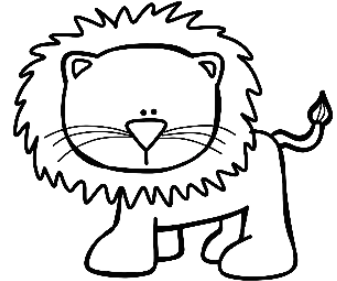
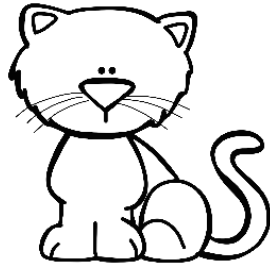

Colour the letter. 1 - red

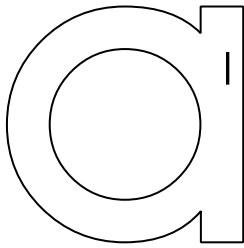

Read the words.

ant

apple

ape

anchor

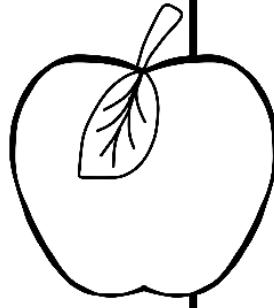
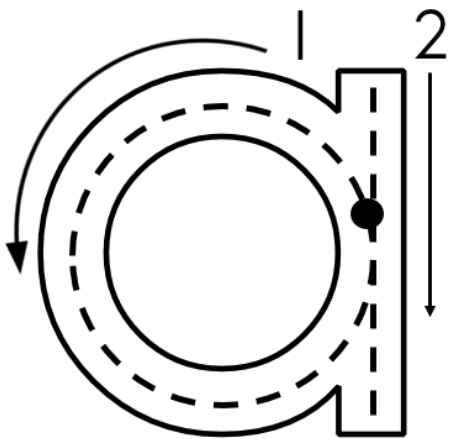

Circle all the "a" letters.

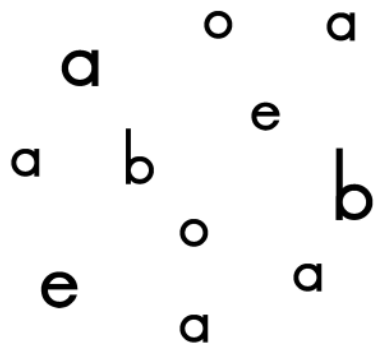

Practice writing the letter.

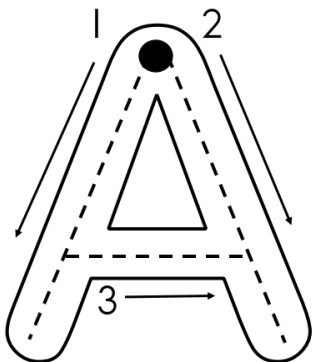
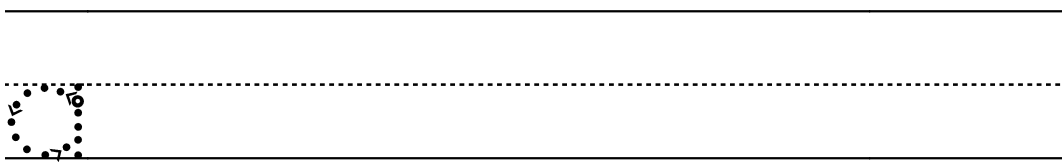

Practice writing the capital letter.

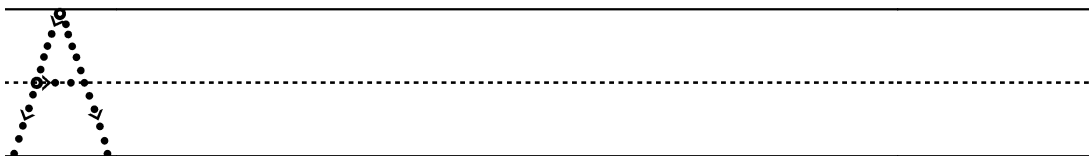

# "a" sound

Colour all the pictures that start with the "a" sound.

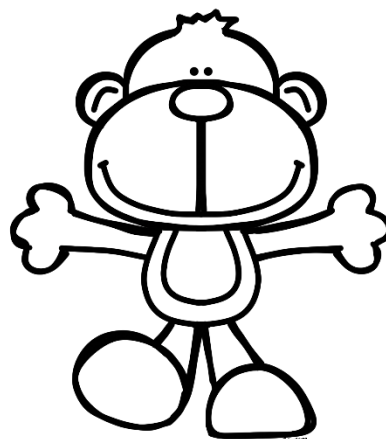
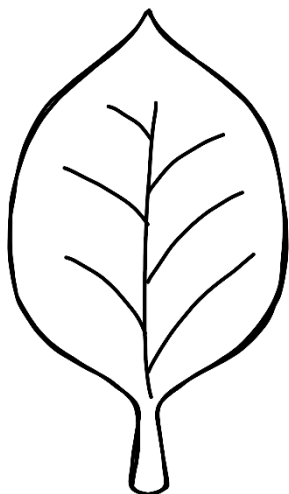
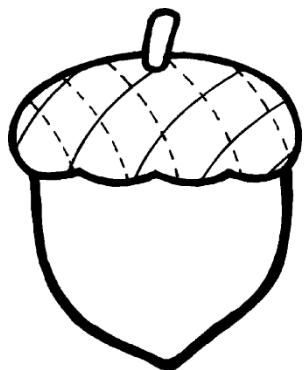
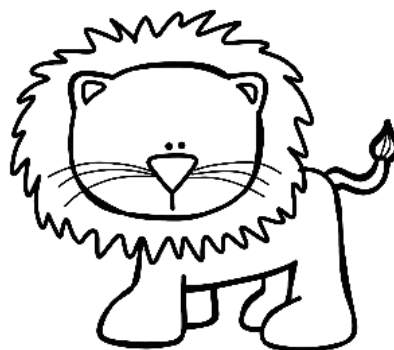
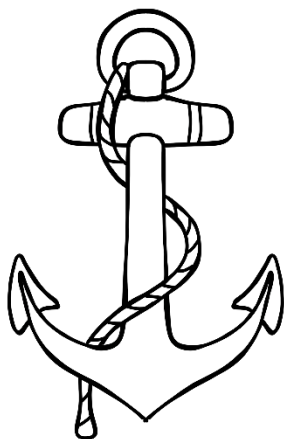
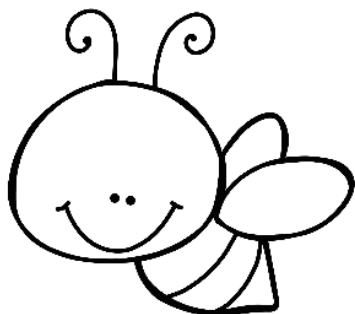
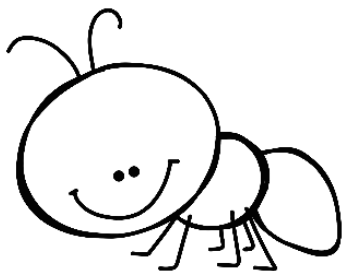
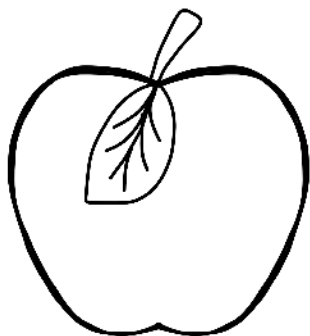

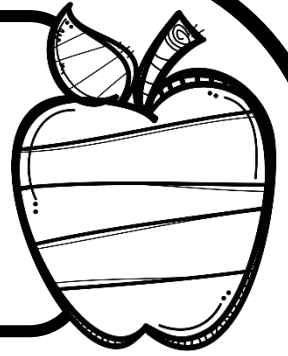
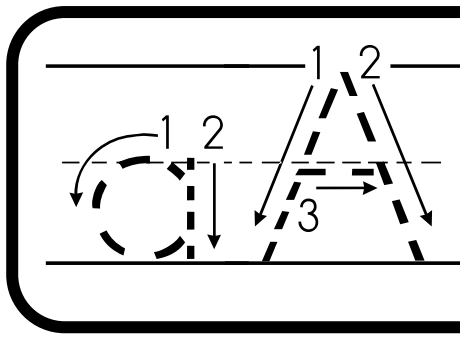

\_\_\_\_\_

o o o o o o o

A A A A A A

o A o A o A

o A o A o A

o A o A



Colour the pictures that match the first one.

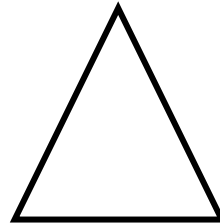
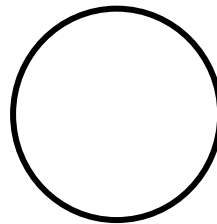
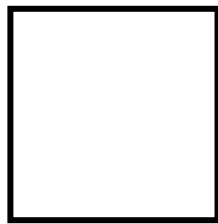
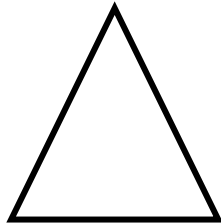
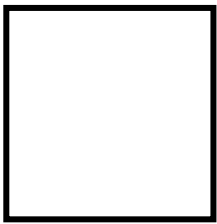
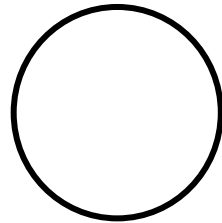
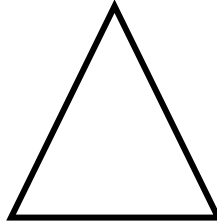
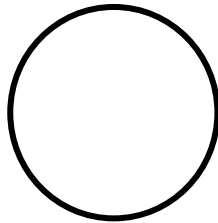
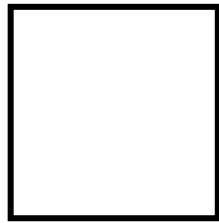
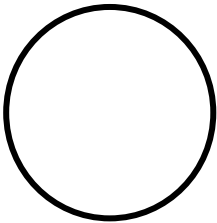
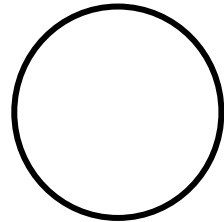
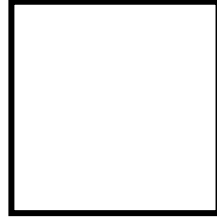
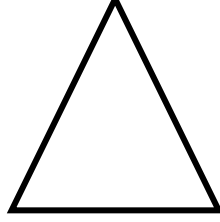
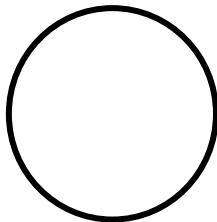
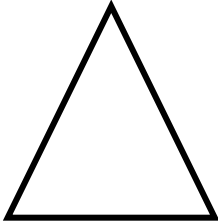
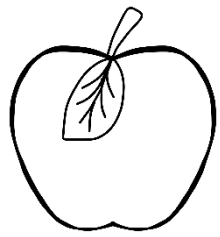
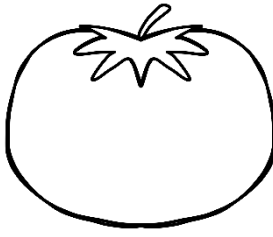
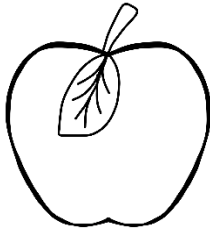
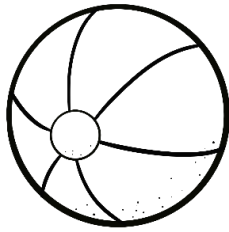
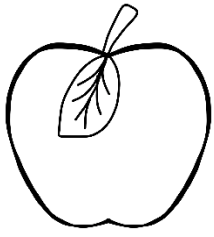

a

a

d

b

a

g

a

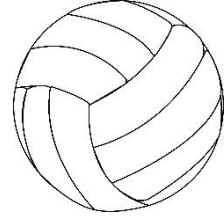
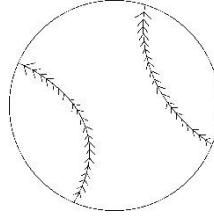
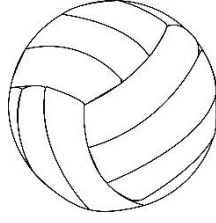
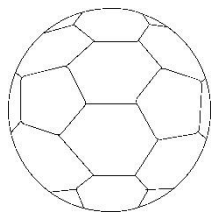
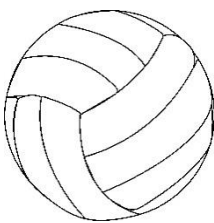

Colour the letter.

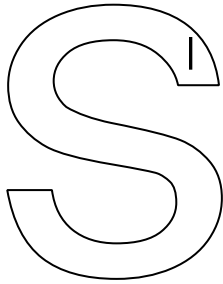

l - purple

Read the words.

|     |       |       |      |
|-----|-------|-------|------|
| say | sea   | see   | sad  |
| sun | snail | snake | star |

Trace over the letter.



Circle all the "s" letters.

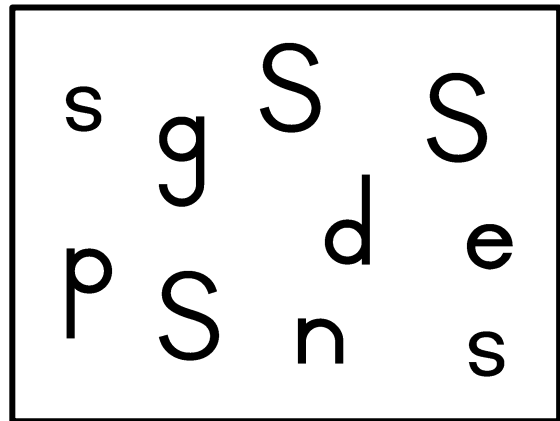

Practice writing the letter.

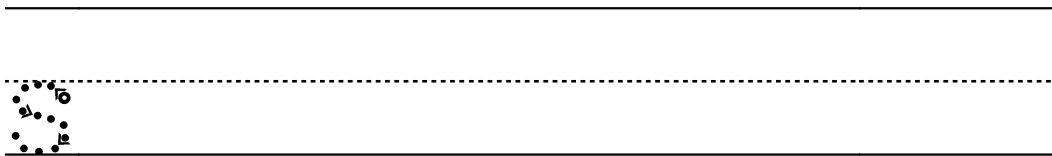

Trace the words.

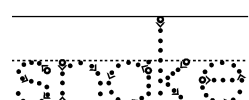
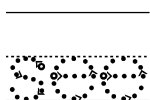
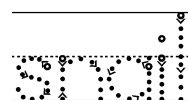
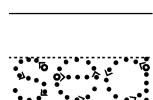
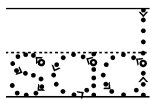

Practice writing the capital letter.

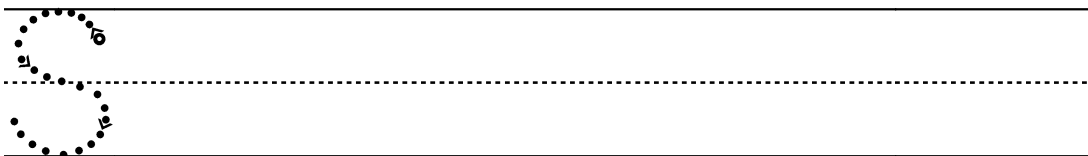

# "s" sound

Colour all the pictures that start with the "s" sound.

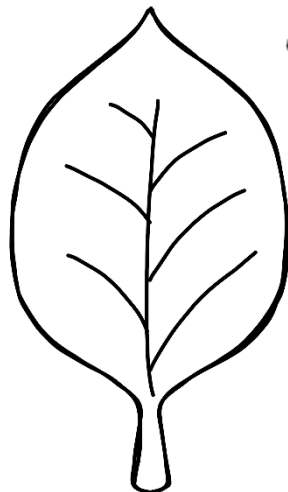
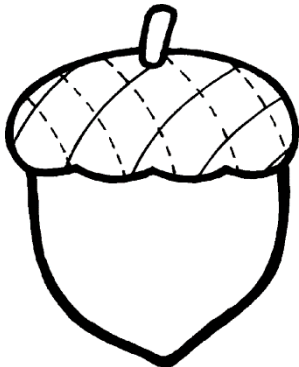
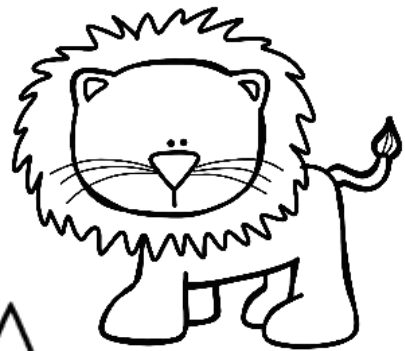
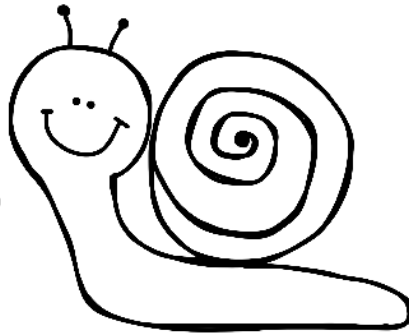
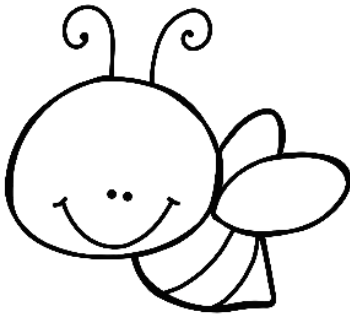
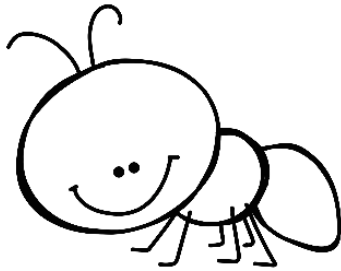
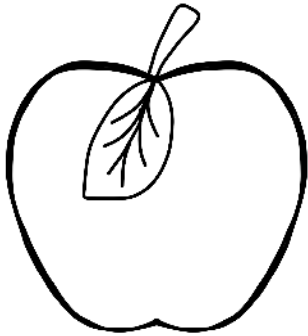



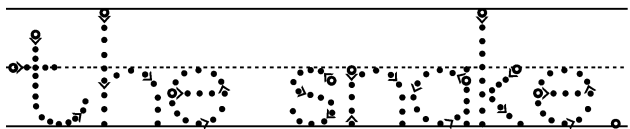
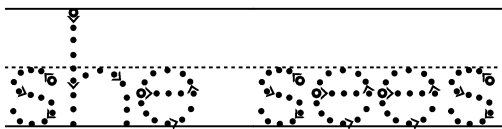
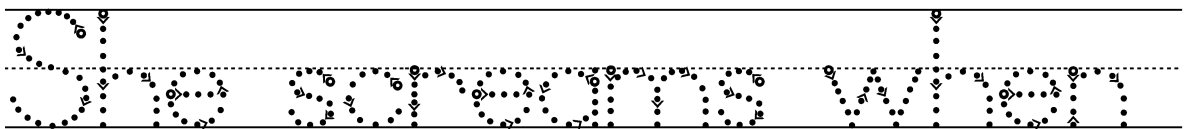
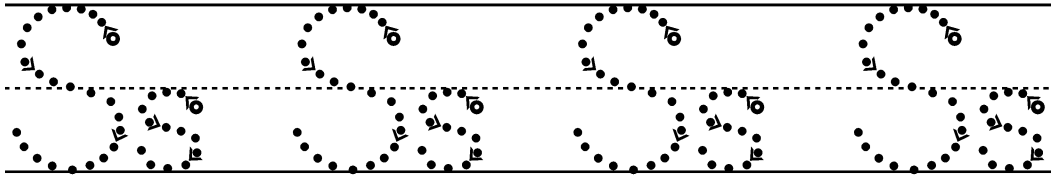
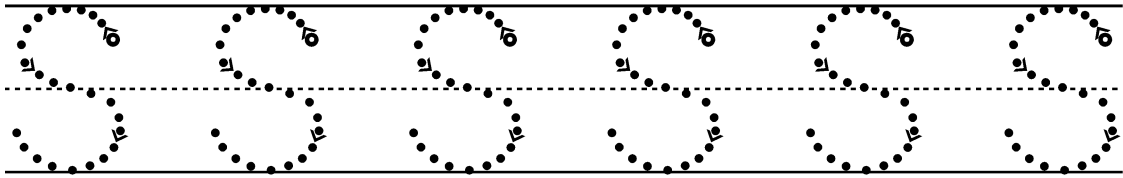
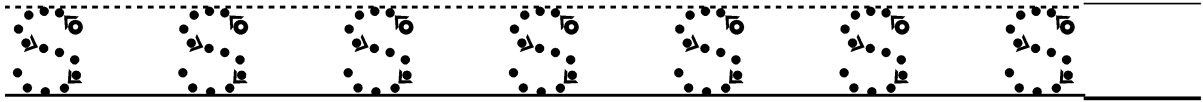
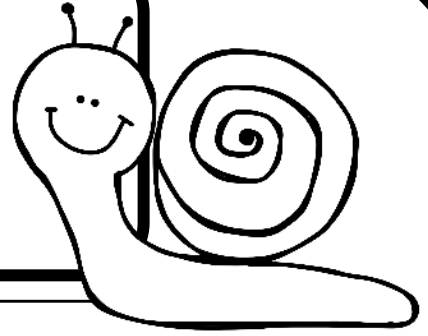
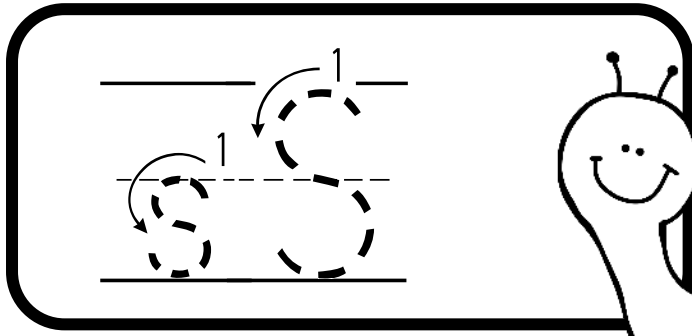

Colour the letter. | - blue

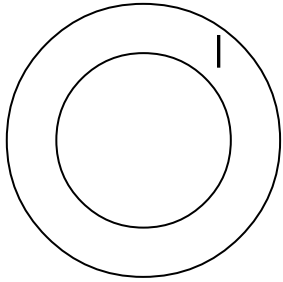

Read the words.

|        |         |       |
|--------|---------|-------|
| out    | owl     | onion |
| orange | octopus |       |

Trace the letter.

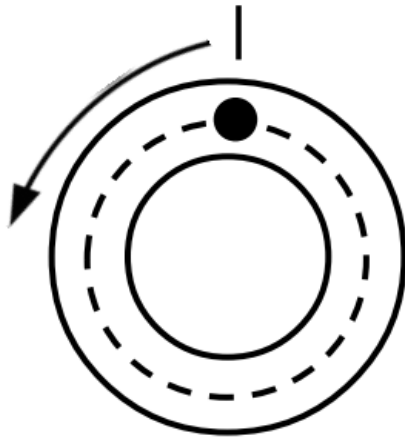

Circle the "o" letters.

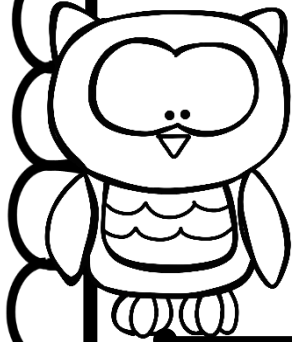
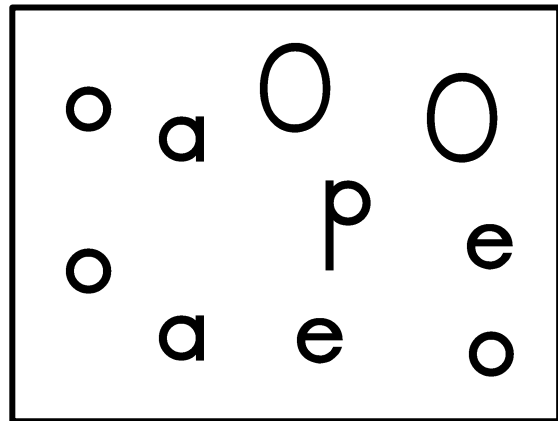

Practice writing the letter.

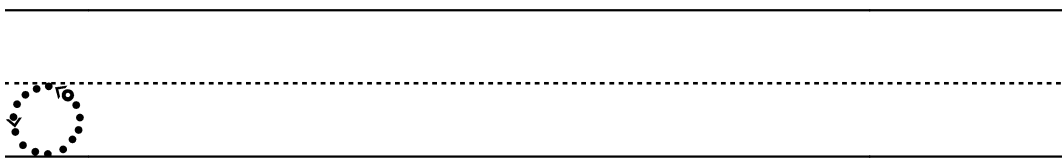

Complete the "o" sound in the words.

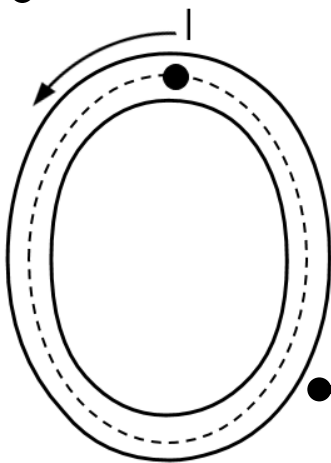

\_\_wl  
\_\_nion

d\_\_lphin  
\_\_ctopus

Practice writing the capital letter.

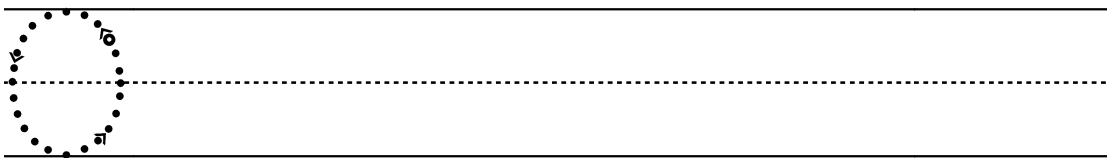

# "o" sound

Colour all the pictures that start with the "o" sound.

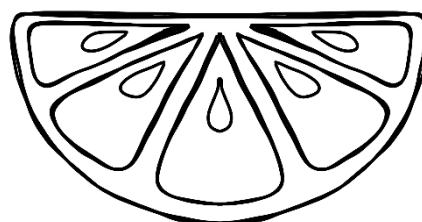
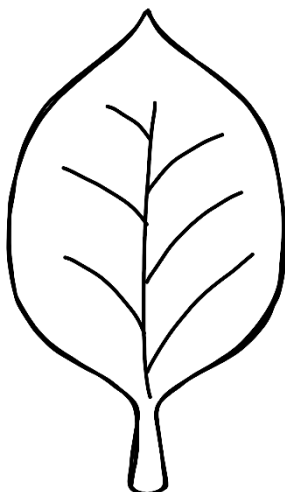
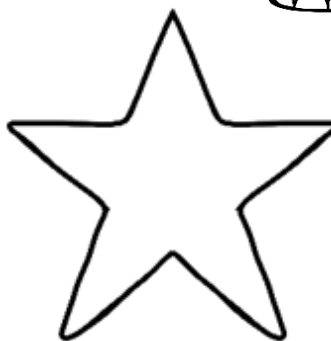
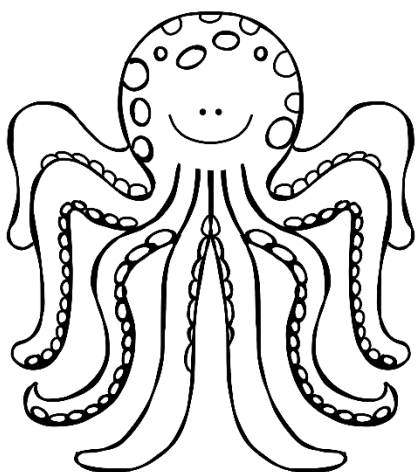
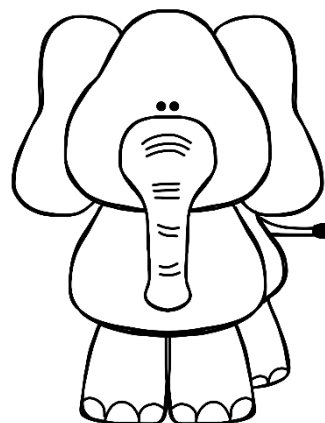
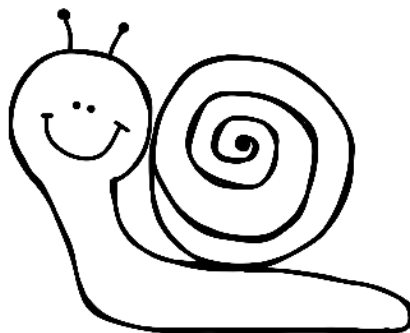
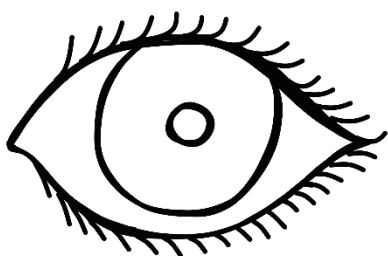
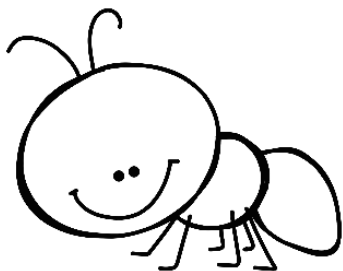
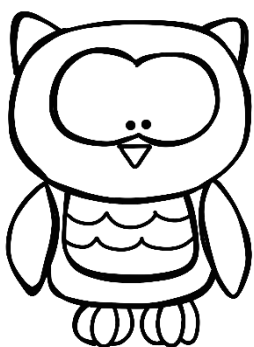

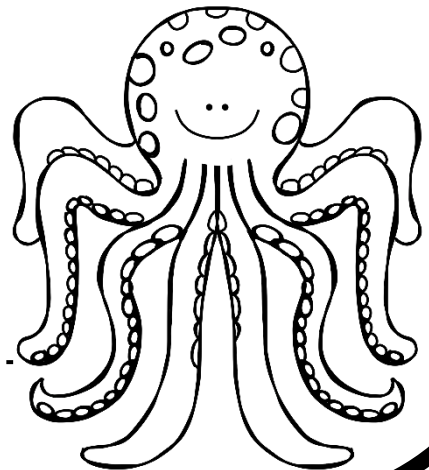
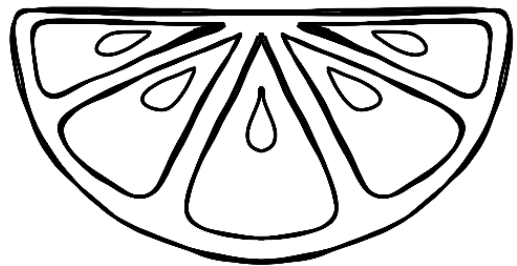
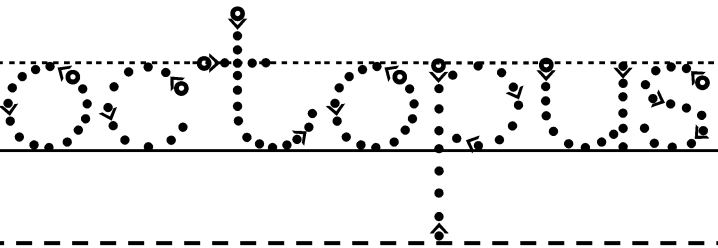
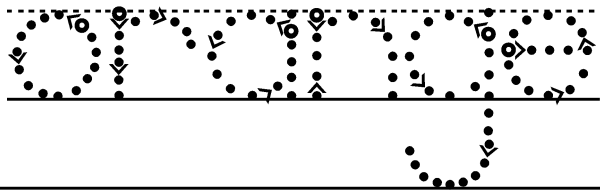
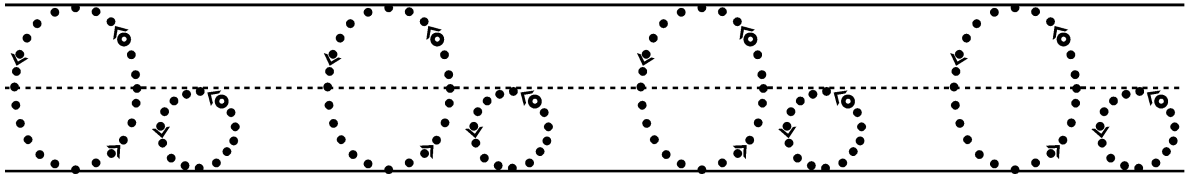
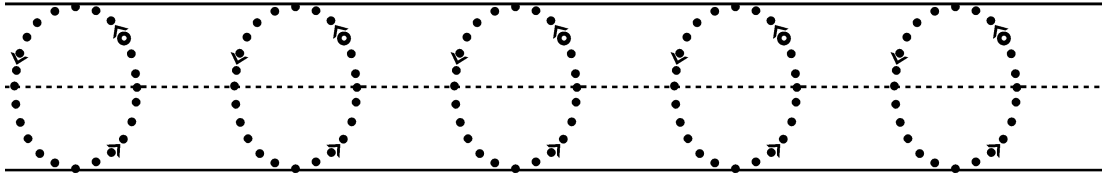
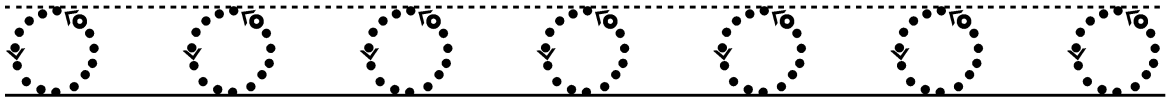
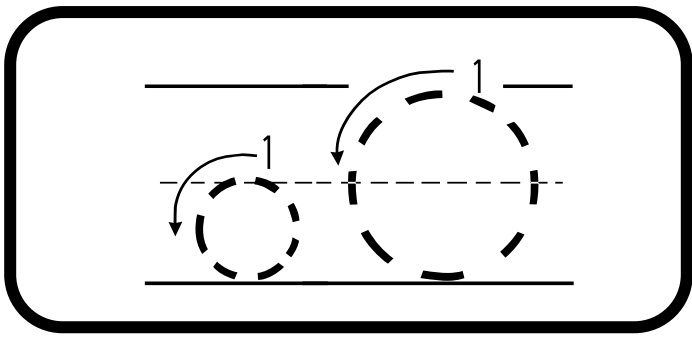

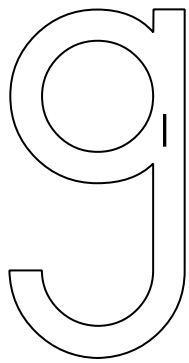

Colour the letter.

l - green

Read the words.

|       |       |       |        |
|-------|-------|-------|--------|
| grass | glass | green | glue   |
| goose | goat  | girl  | grapes |

Trace the letter.

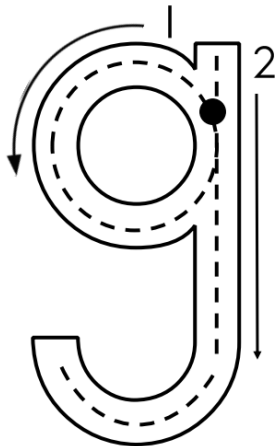
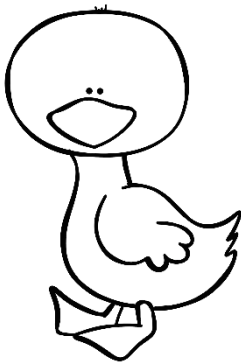

Circle the "g" sound.

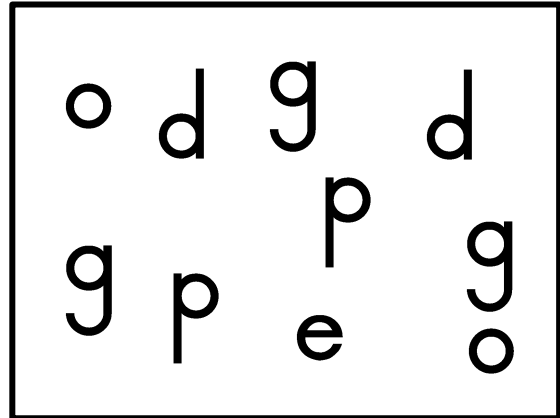

Practice writing the letter.

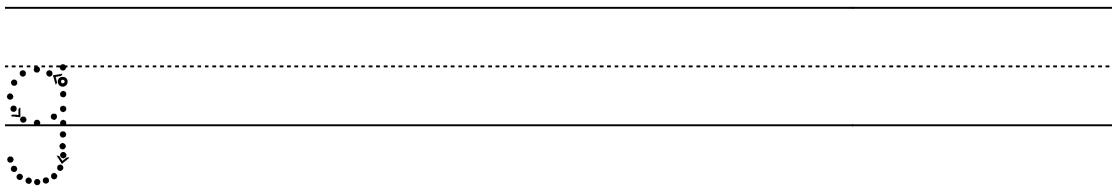

Complete the "g" sound in the words.

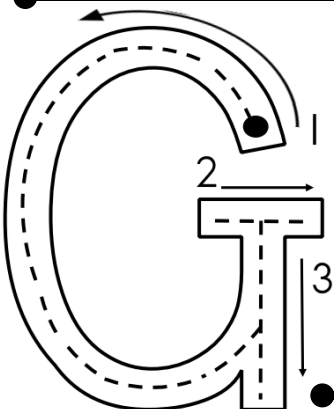

\_\_reen | \_\_rapes  
 \_\_rass | \_\_lass

Practice writing the capital letter.

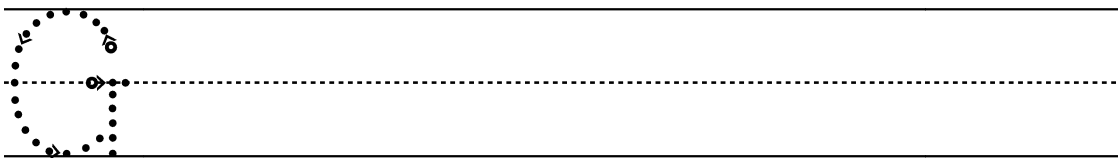

# "g" sound

Colour all the pictures that start with the "g" sound.

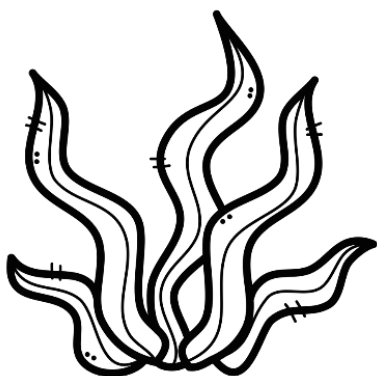
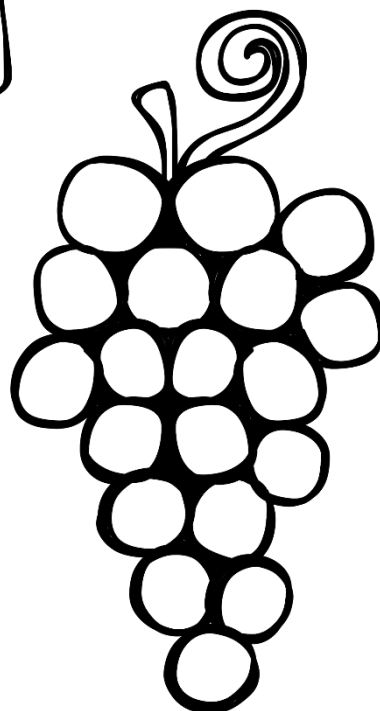
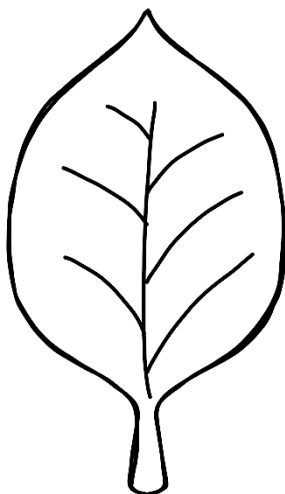
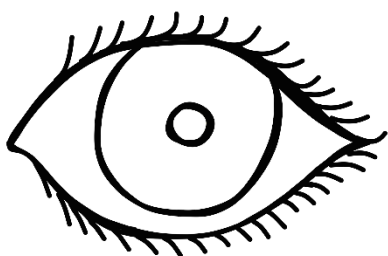
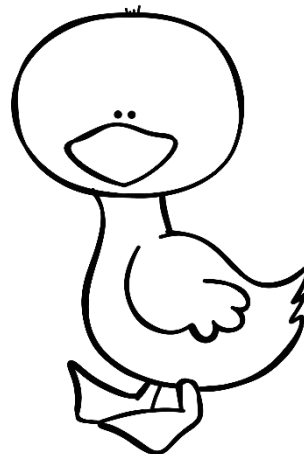
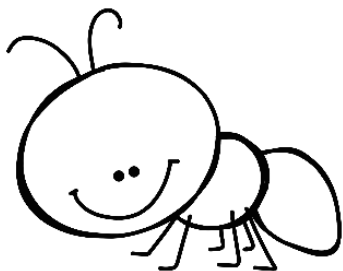
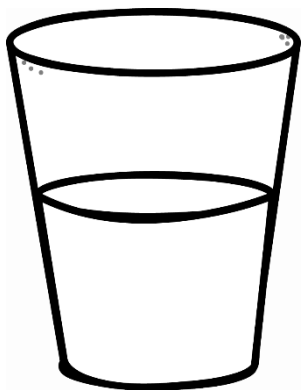

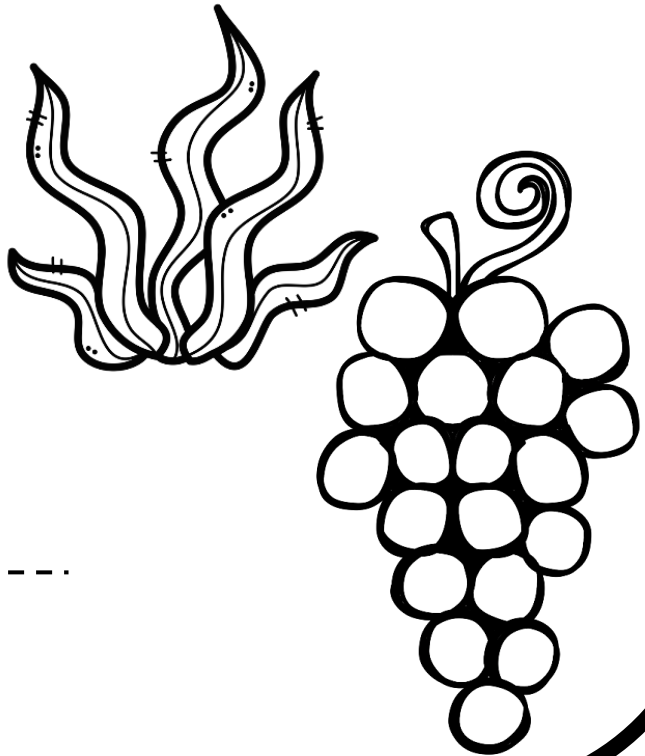
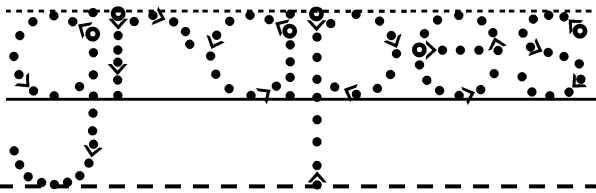
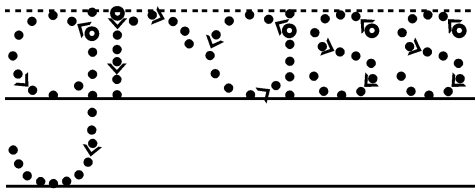
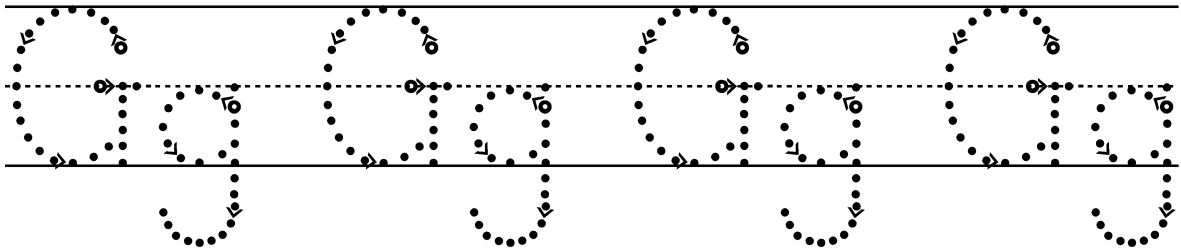
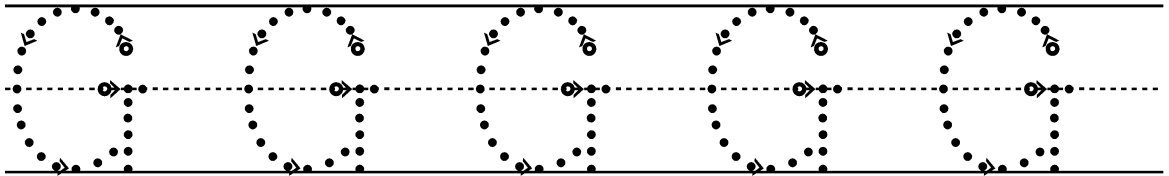
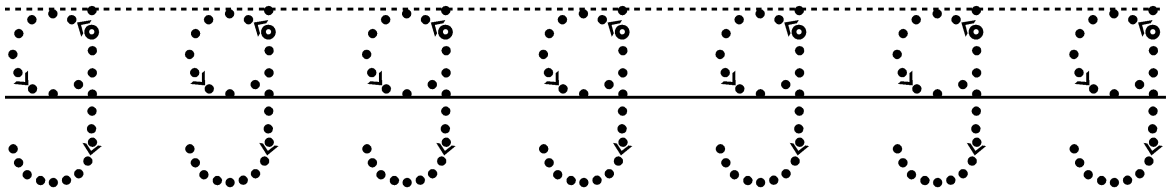
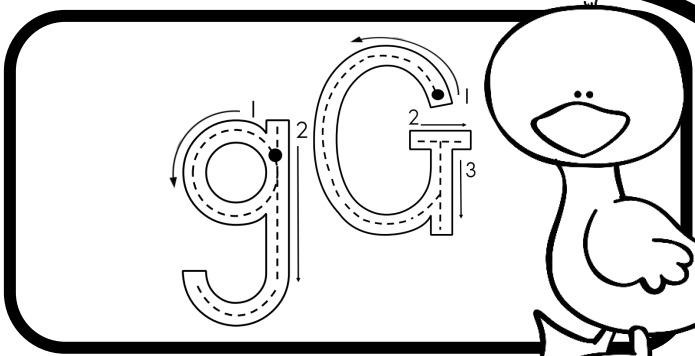

Colour the letter.



l - yellow

Read the words.

|       |       |      |      |
|-------|-------|------|------|
| leg   | lion  | leaf | lamp |
| laugh | light | lip  | lamb |

Trace the letter.

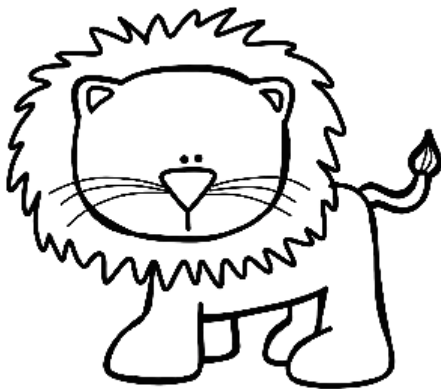

Circle all the "l" sounds.

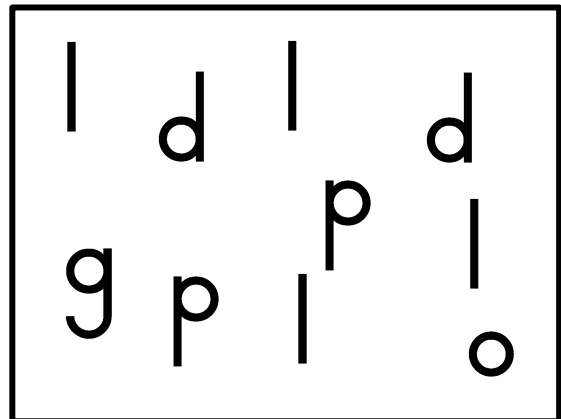

Practice writing the letter.

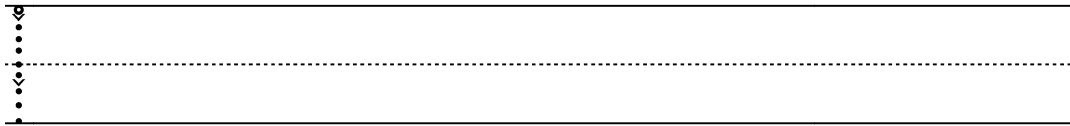

Complete the "l" sound in the words.

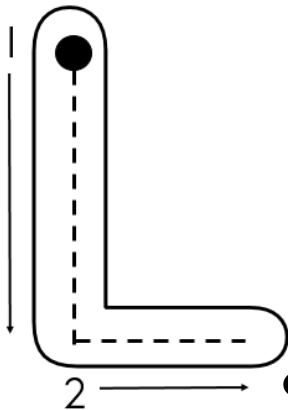

\_\_amp

\_\_eg

\_\_ion

\_\_eaf

Practice writing the capital letter.

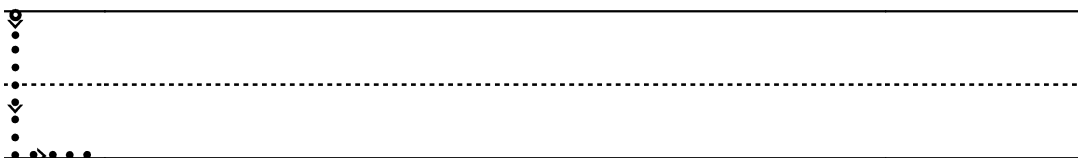



# "l" sound

Colour all the pictures that start with the "l" sound.

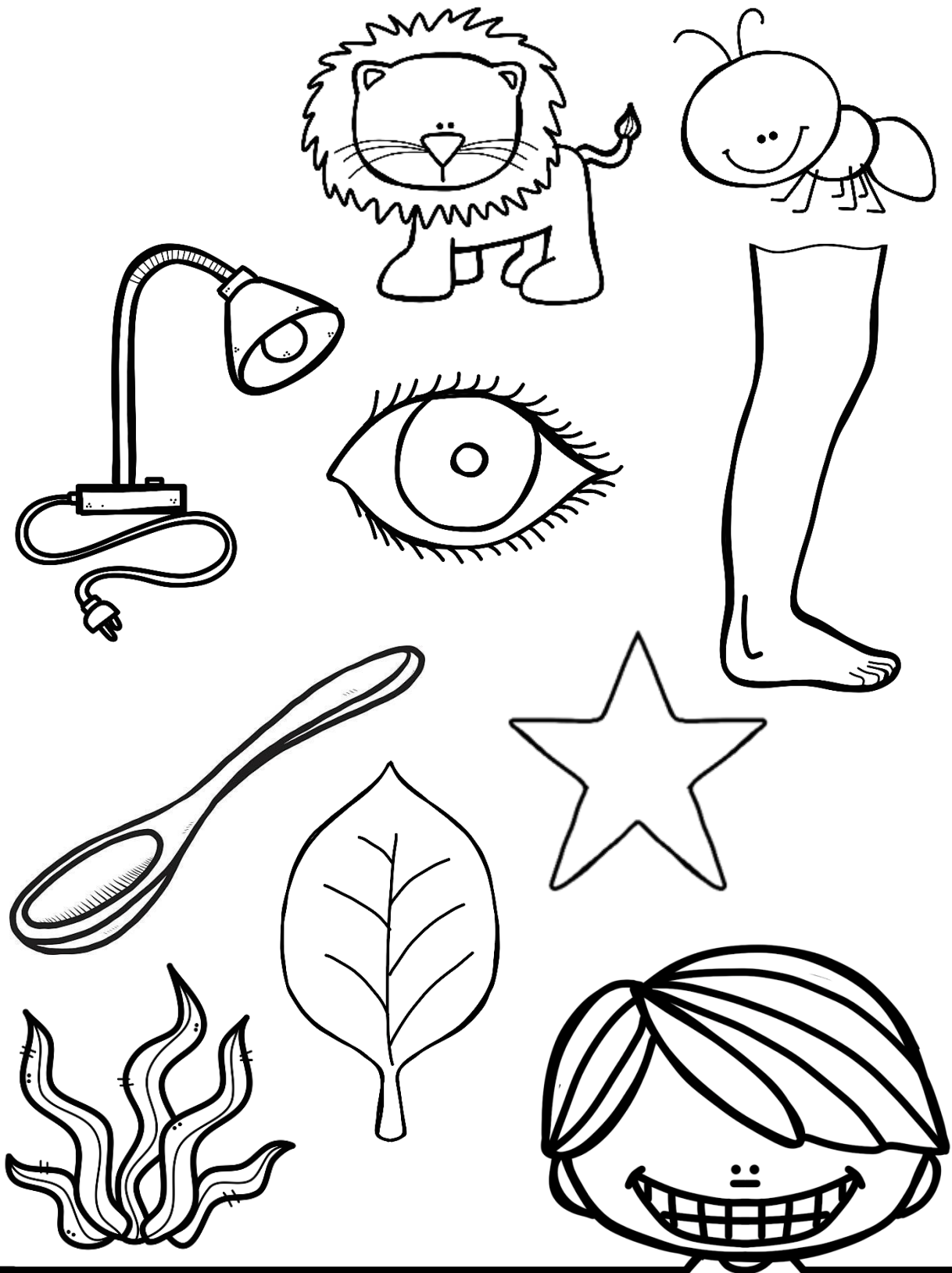

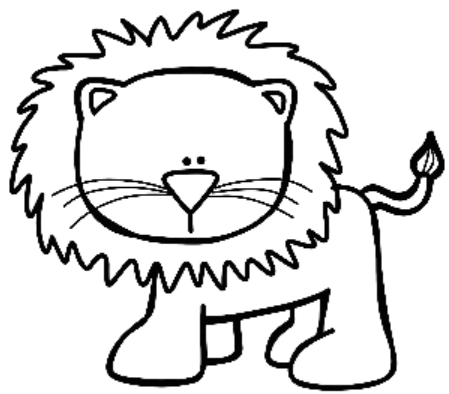
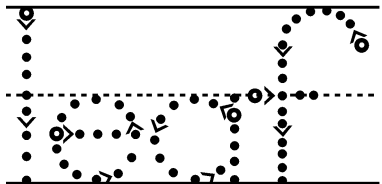
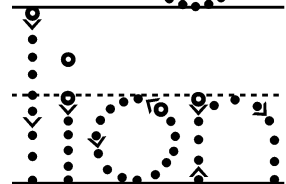
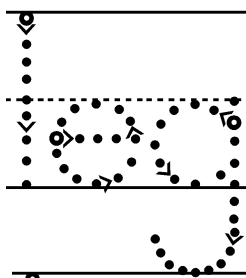
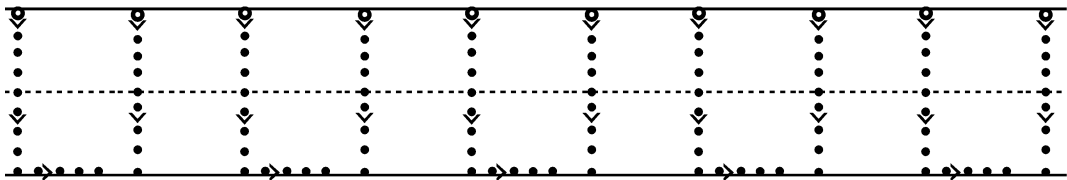
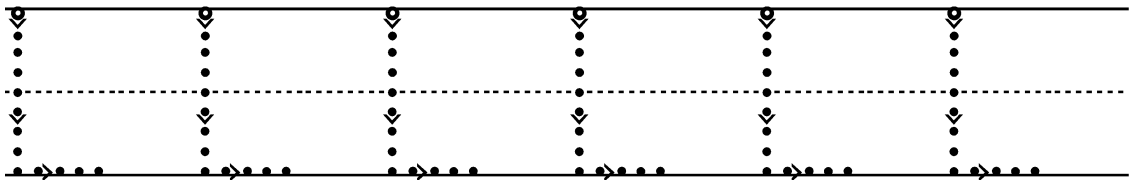
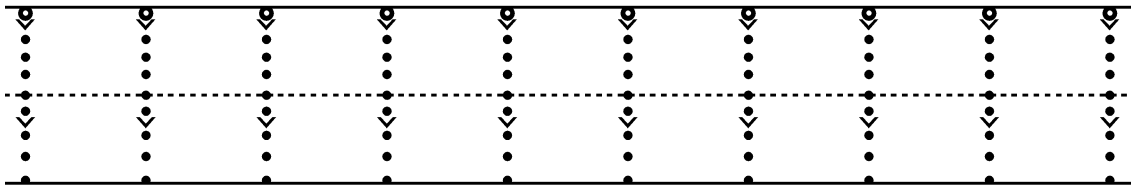
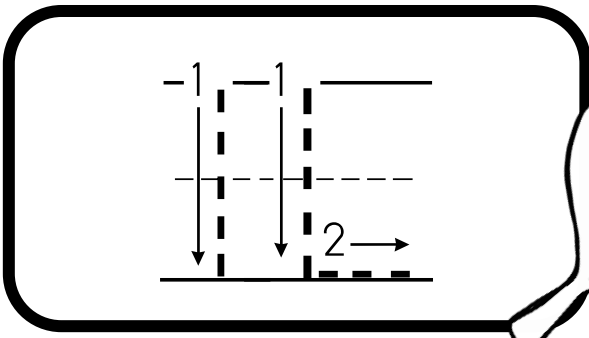

Colour the letter. l - pink

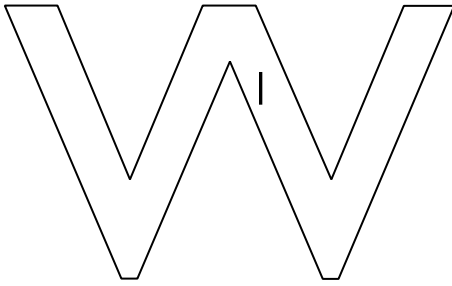

Read the words.

|       |       |            |      |
|-------|-------|------------|------|
| we    | who   | where      | why  |
| when  | whale | worm       | wool |
| water | wagon | watermelon |      |

Trace the letter.



Circle all the "w" sounds.

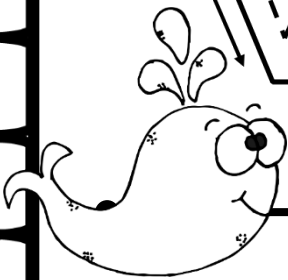
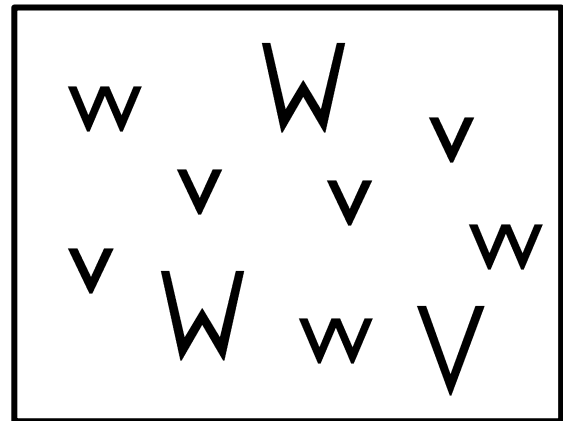

Practice writing the letter.

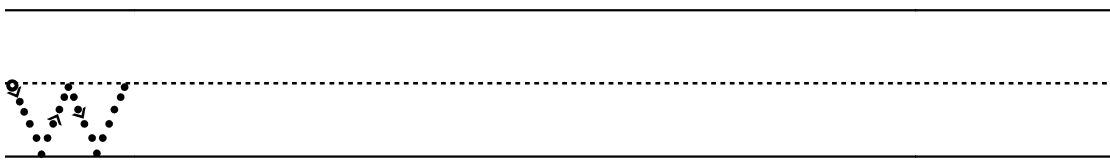

Complete the words by filling in the "w" sound.

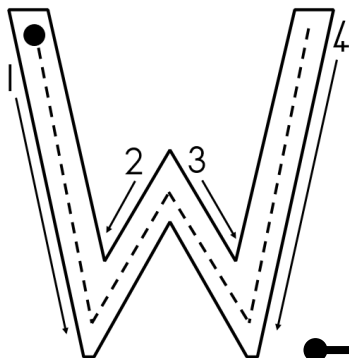

|        |  |        |
|--------|--|--------|
| __hale |  | __orm  |
| __ater |  | __here |
| __ool  |  | __hy   |

Practice writing the capital letter.

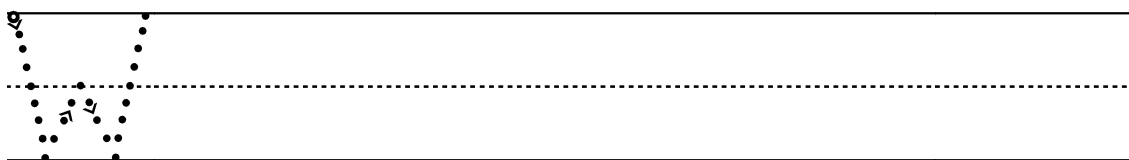

# "w" sound

Colour all the pictures that start with the "w" sound.

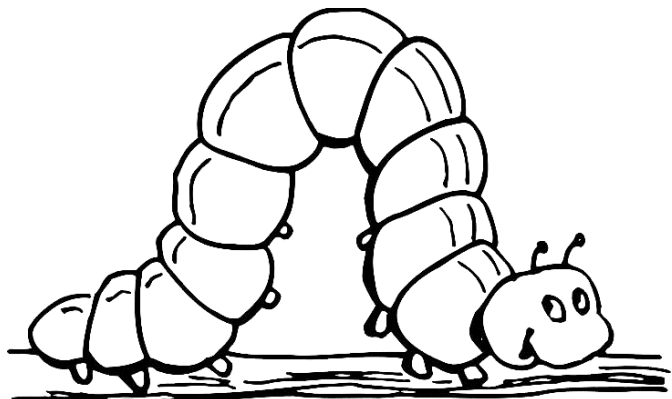
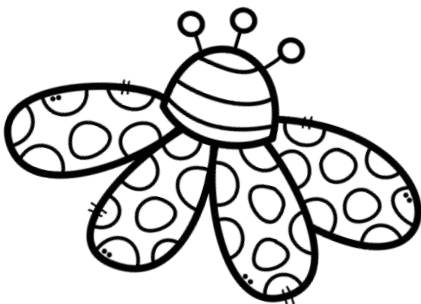
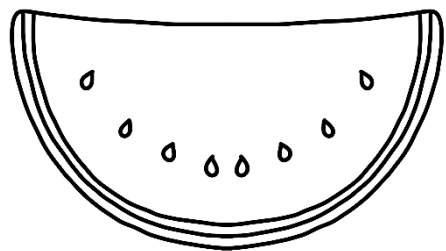
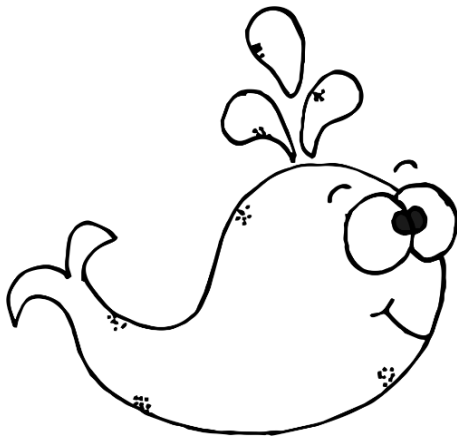
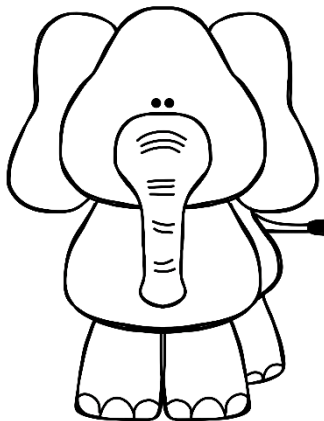
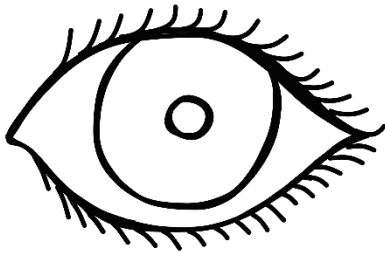
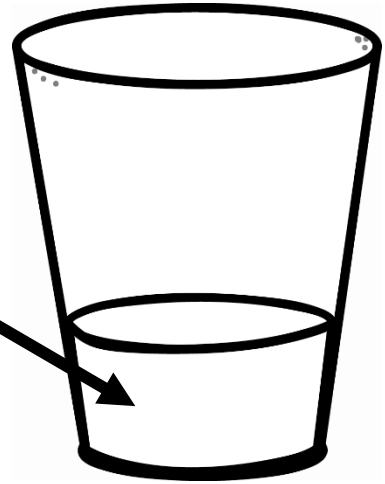
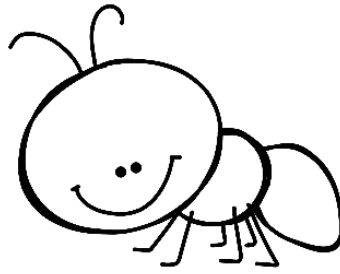
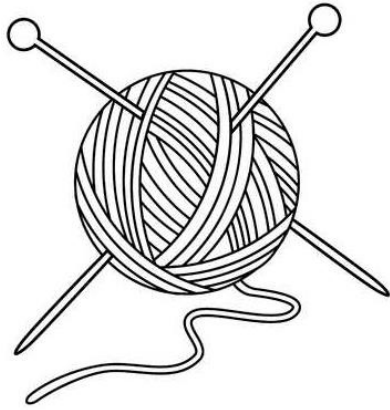

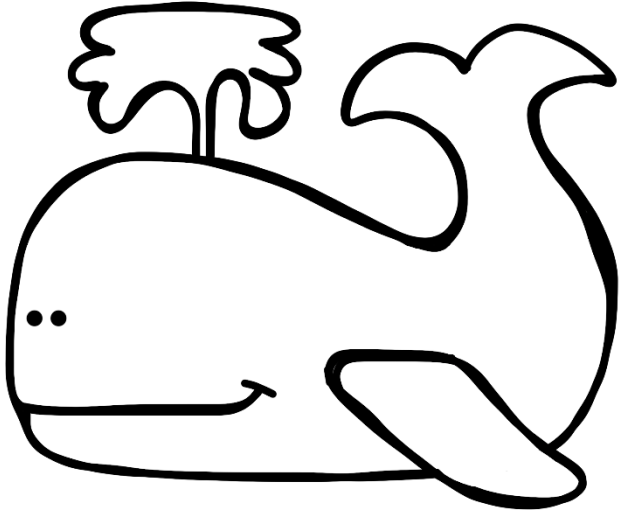
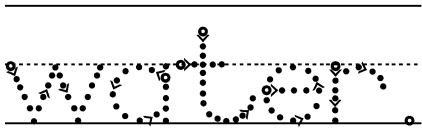
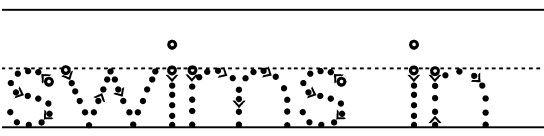
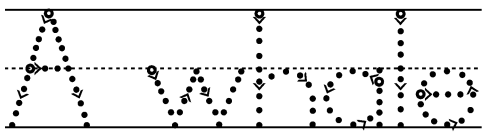
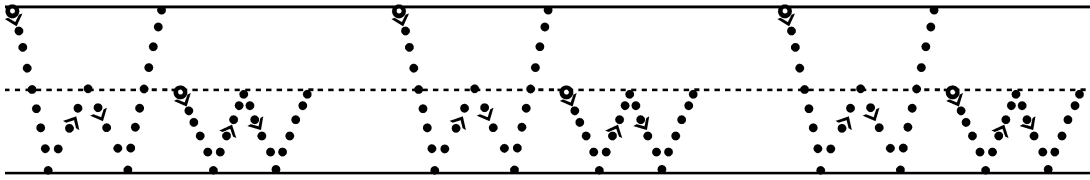
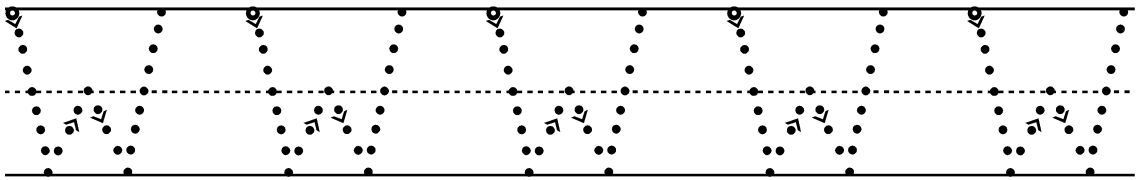
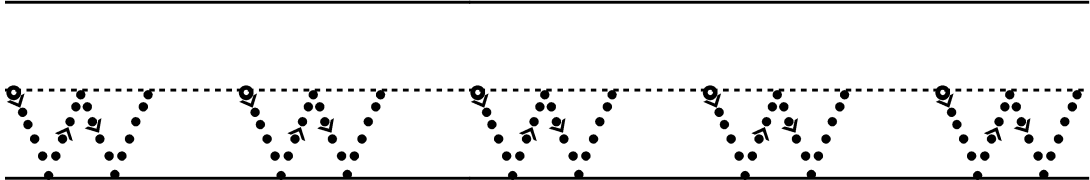
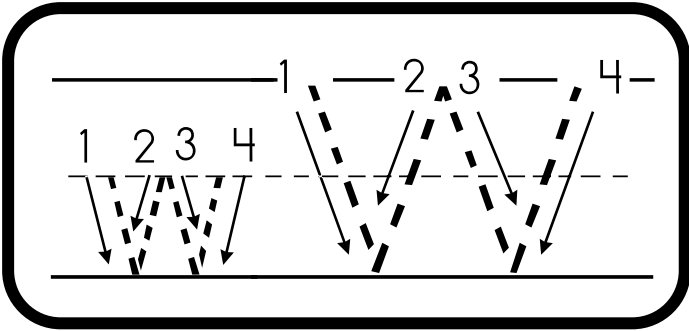

2  
○

Colour the letter.



1 - purple

2 - green

Read the words.

|           |        |     |
|-----------|--------|-----|
| ink       | igloo  | ice |
| ice cream | insect |     |

Trace the letter.

2  
○

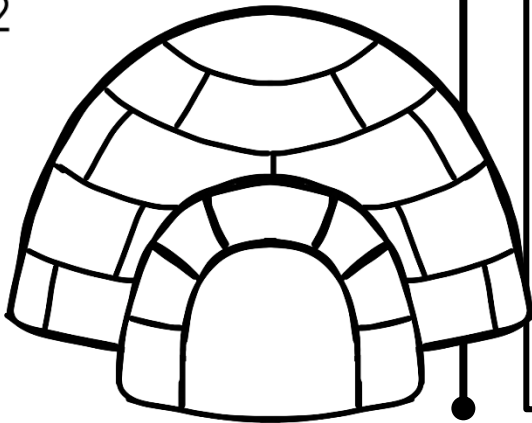

Circle all the "i" sounds.

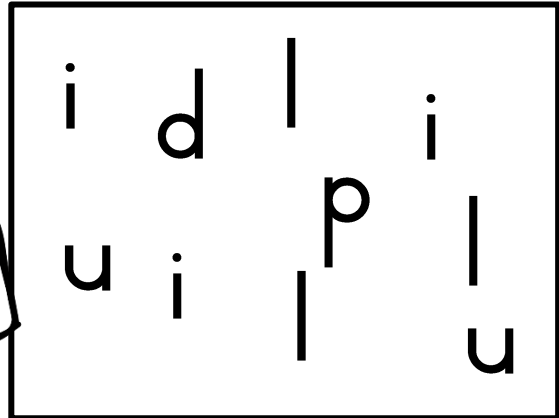

Practice writing the letter.

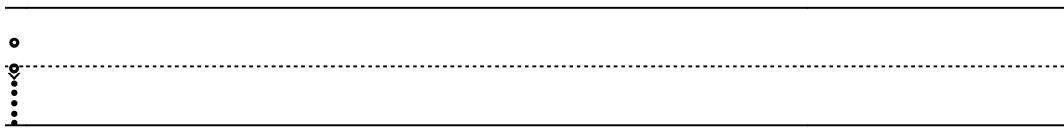

Complete the "i" sounds in the words.

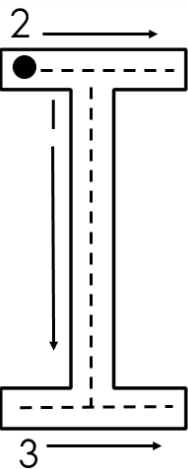

\_\_nsect

\_\_nk

\_\_gloo

\_\_ce

Practice writing the capital letter.

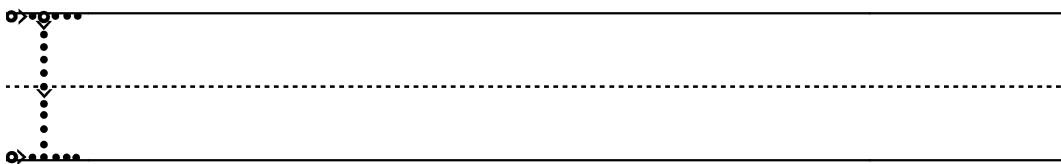

# "i" sound

Colour all the pictures that start with the "i" sound.

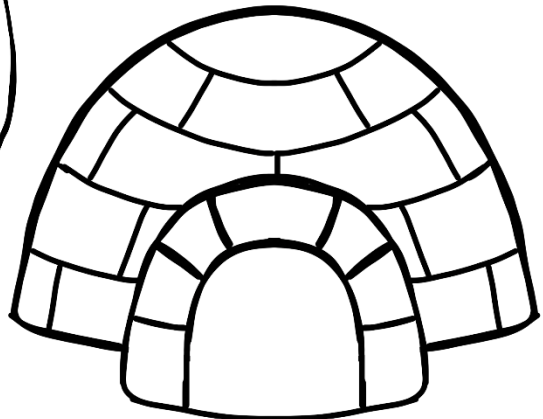
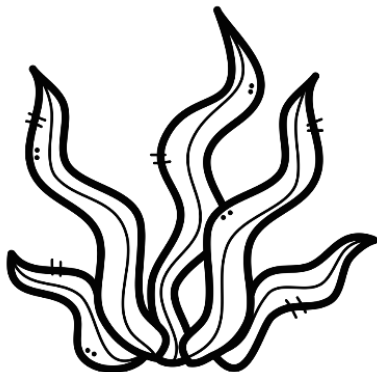
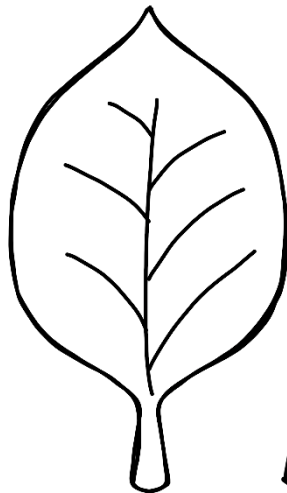
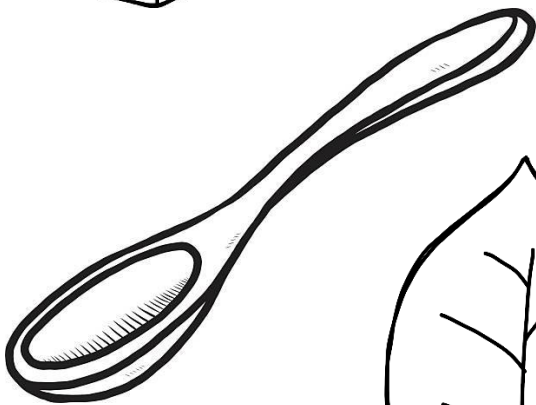
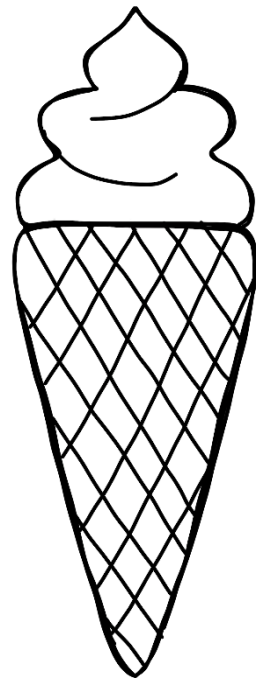
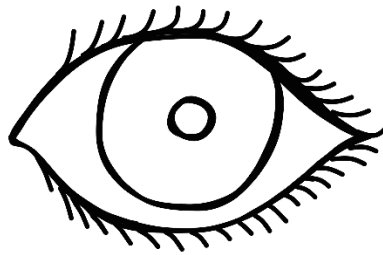
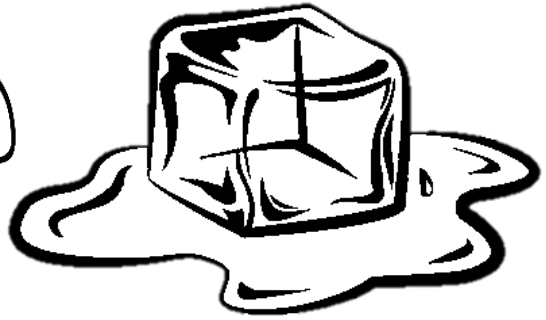
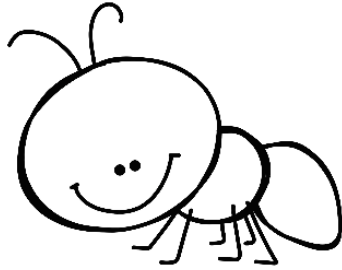

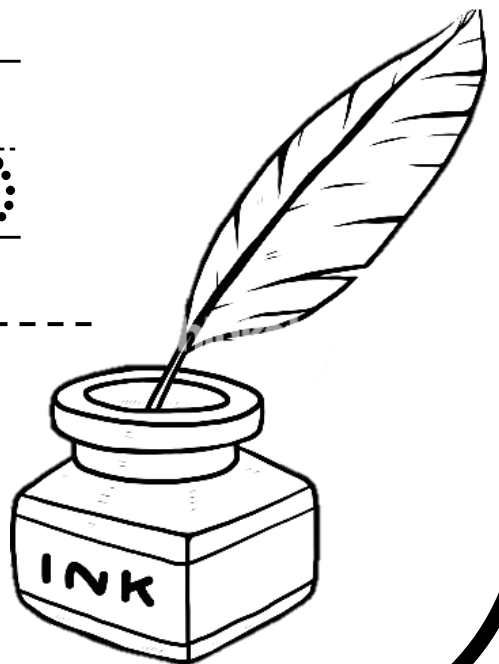
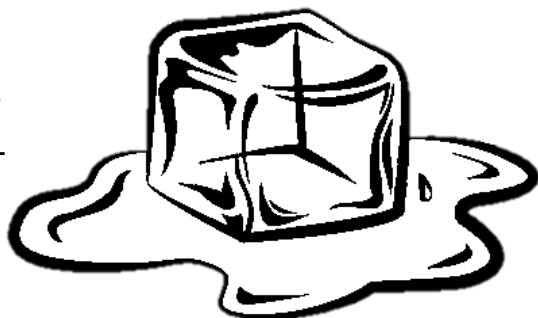
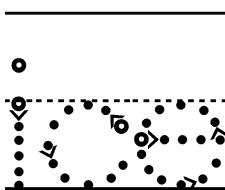
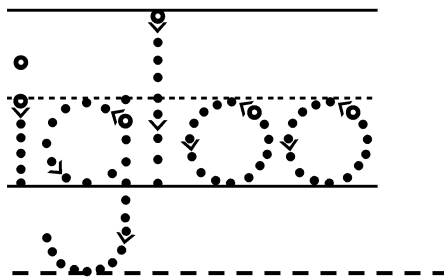
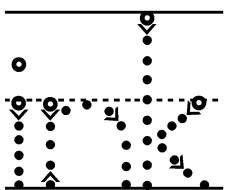
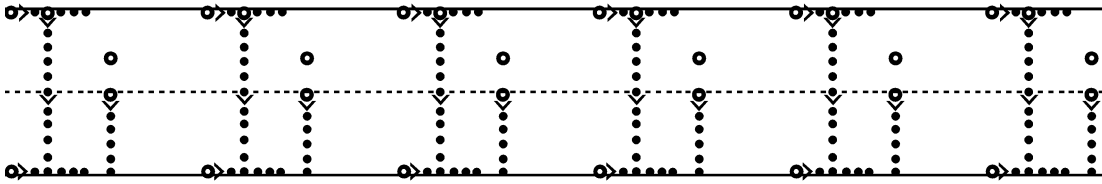
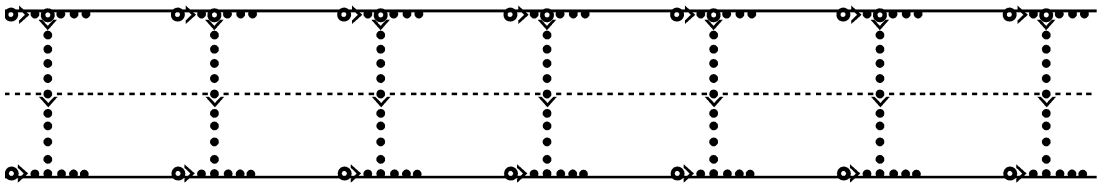
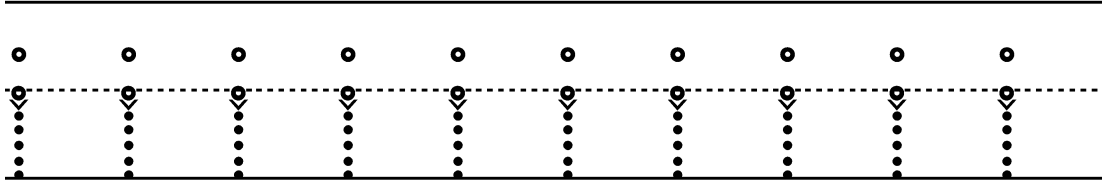
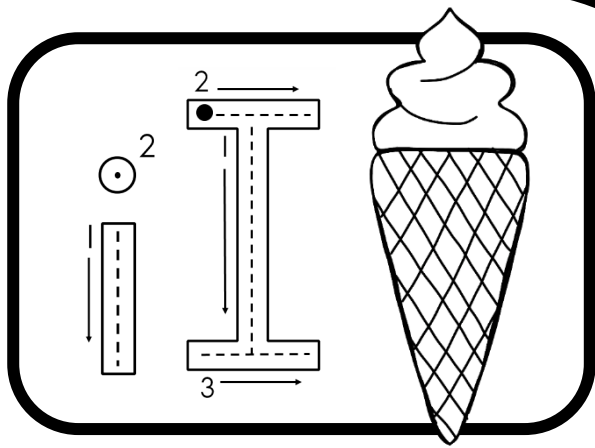



Colour the letter.

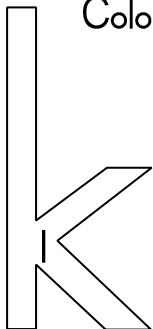

l - orange

Read the words.

key

kite

kangaroo

Trace the letter.

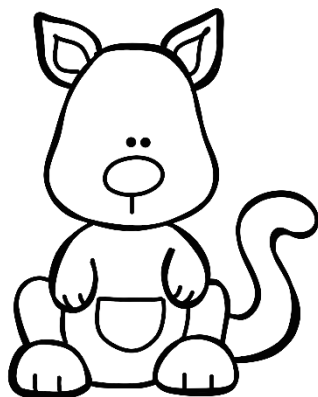
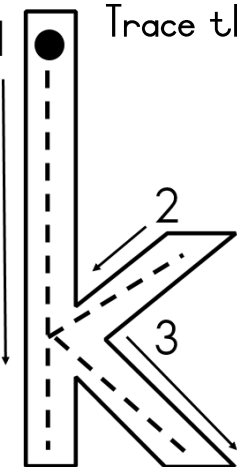

Circle all the "k" sounds.

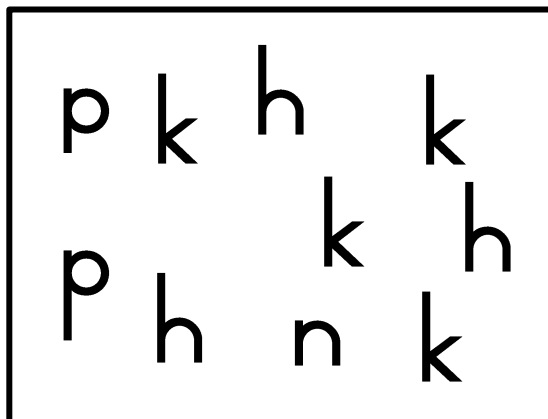

Practice writing the letter.

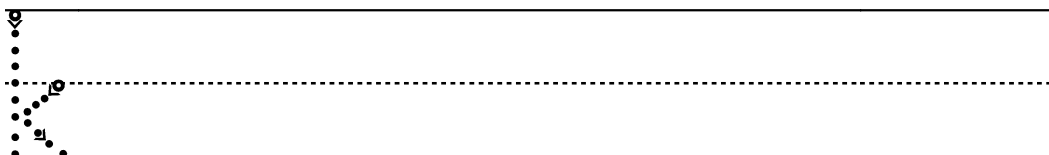

Trace the words.

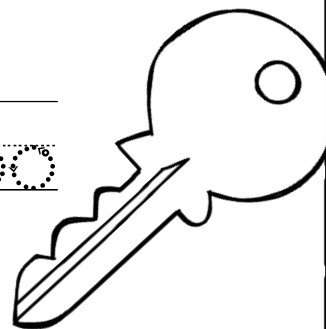
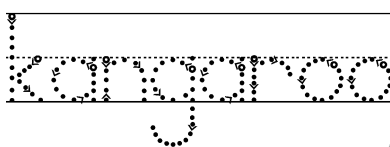
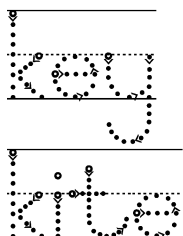
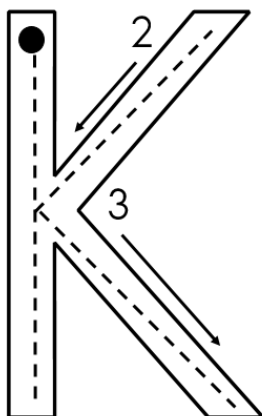

Practice writing the capital letter.

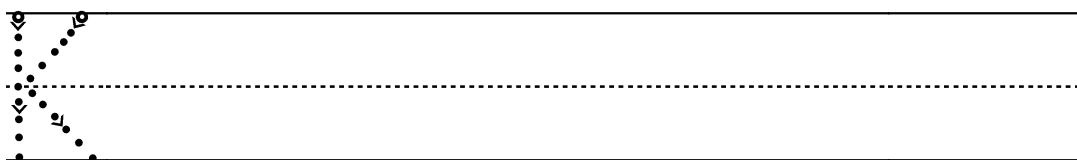

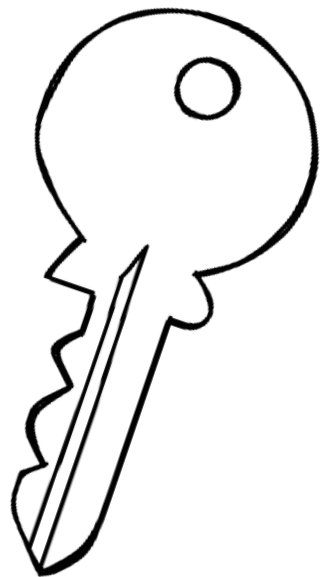
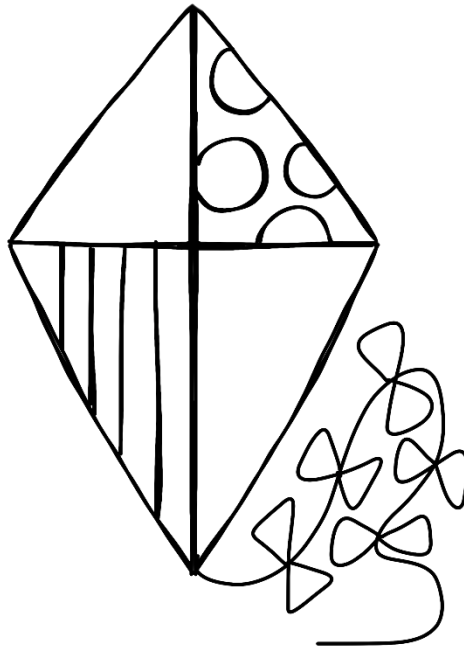
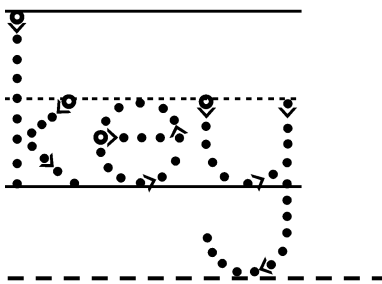
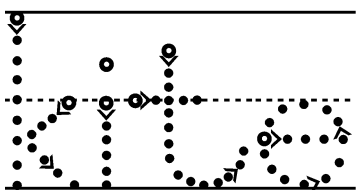
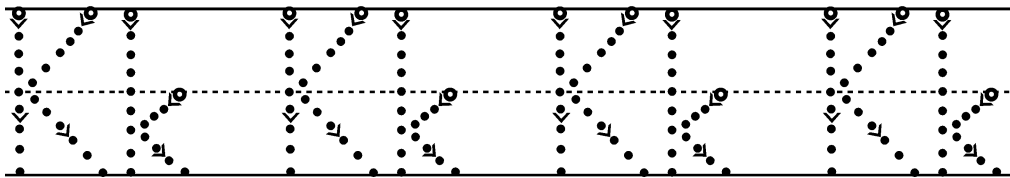
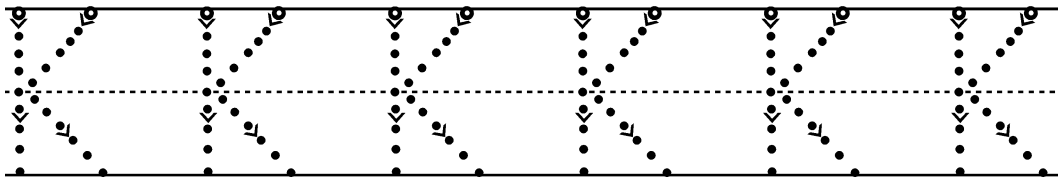
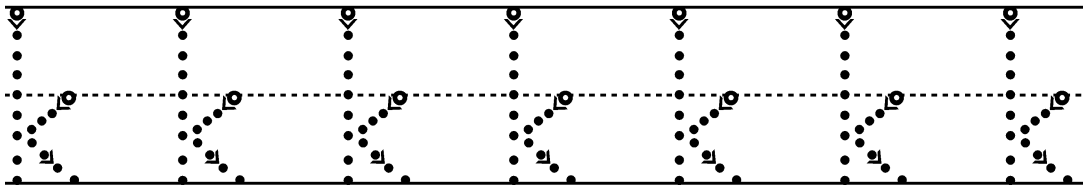
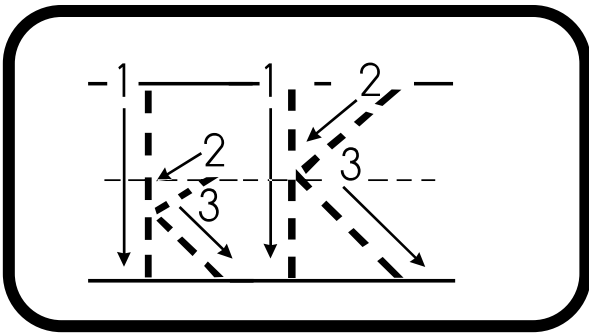

Colour the letter.

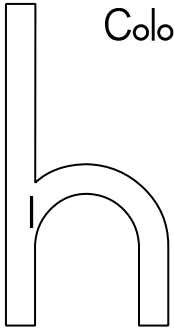

l - grey

Read the words.

|       |      |       |       |
|-------|------|-------|-------|
| he    | her  | him   | heart |
| house | hat  | horse | hop   |
| help  | hair | hand  | hut   |

Trace the letter.

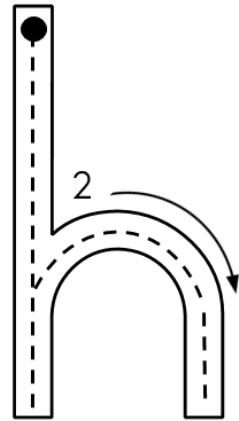

Circle all the "h" sounds.

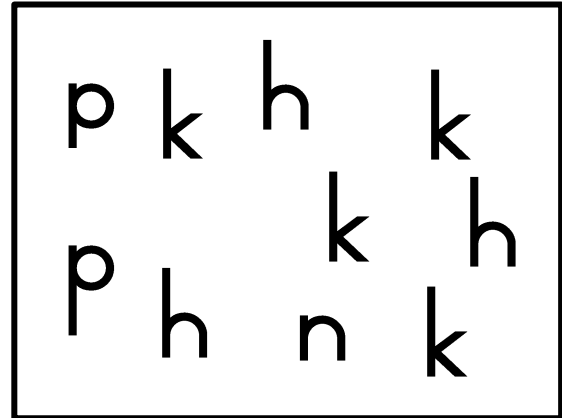

Practice writing the letter.

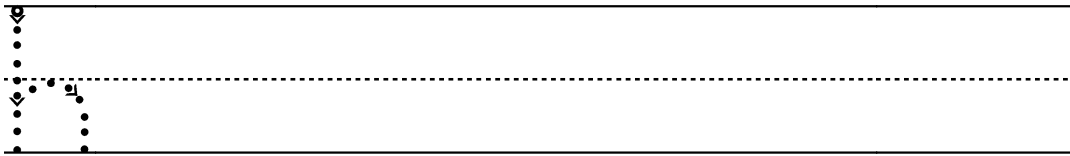

Trace the words.

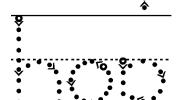
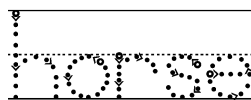
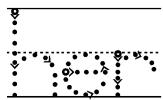
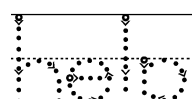
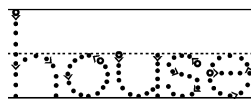
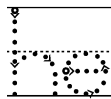
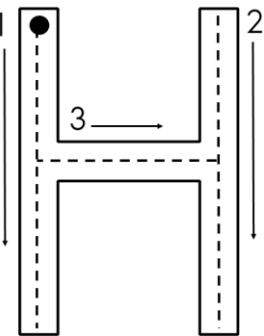

Practice writing the capital letter.

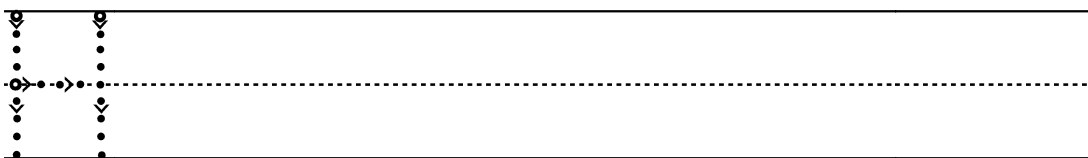

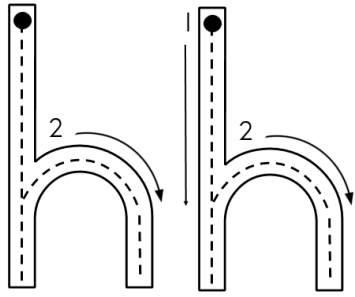

# "h" sound

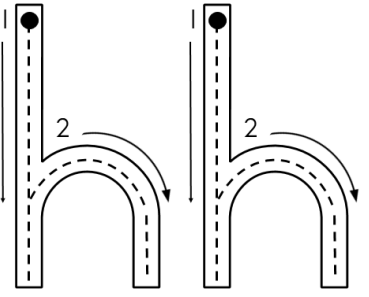

Complete the words.

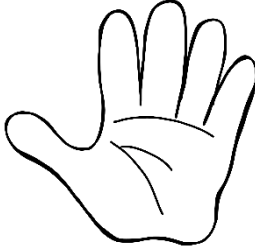

\_\_and

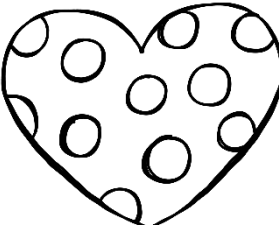

\_\_eart



\_\_ouse

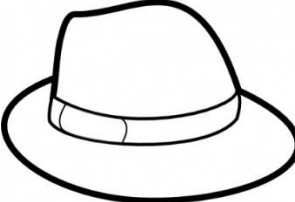

\_\_at

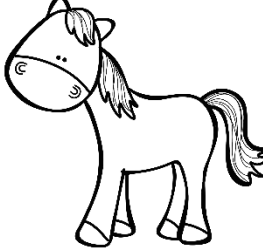

\_\_orse



\_\_ut



\_\_ug



\_\_elp



\_\_it

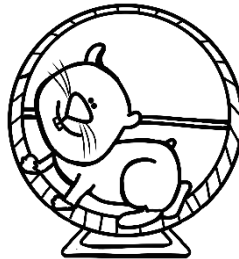

\_\_amster

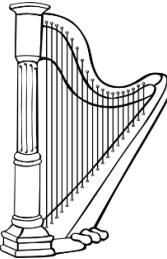

\_\_arp

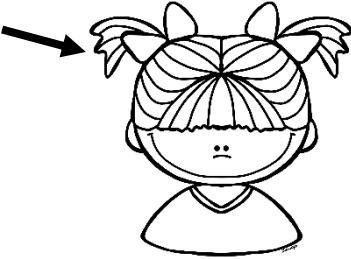

\_\_air

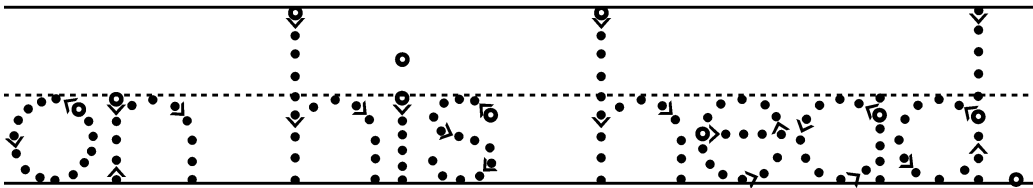
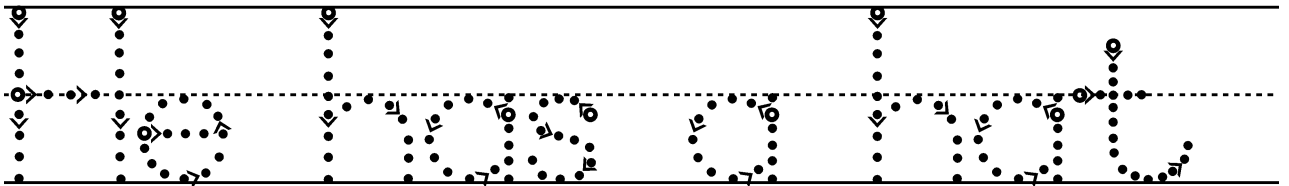
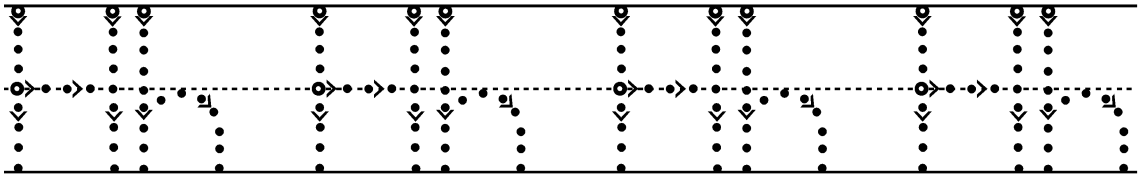
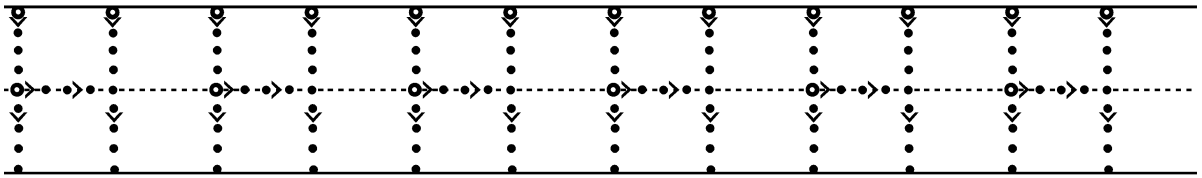
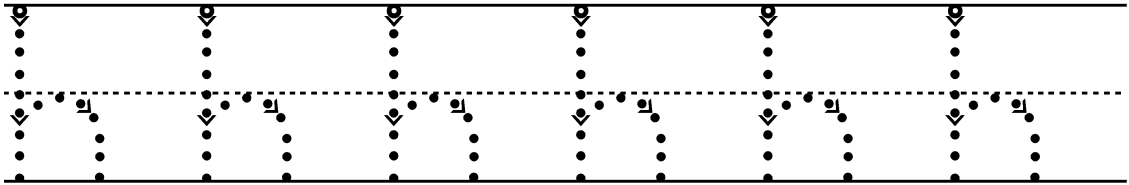
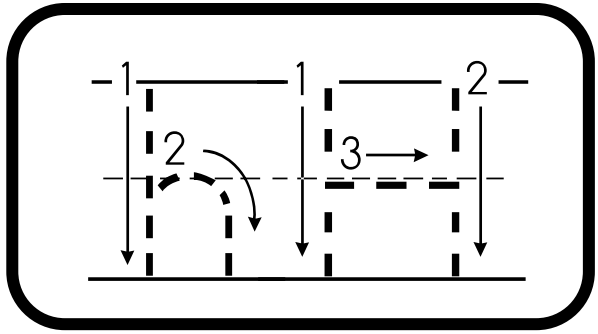
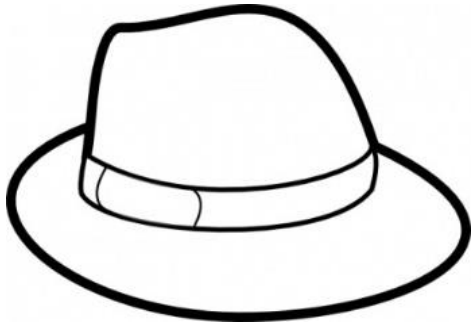

Colour the letter.

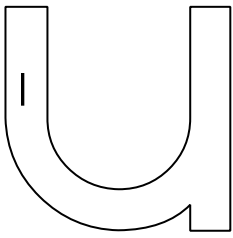

1 - yellow

Read the words.

|          |         |           |
|----------|---------|-----------|
| up       | under   | upset     |
| umbrella | unicorn | underwear |
| us       | urn     | ugly      |

Trace the letter.

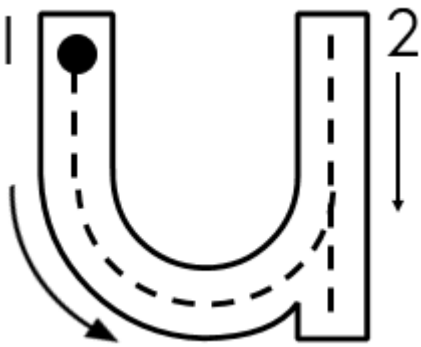

Colour all the "u" sounds.

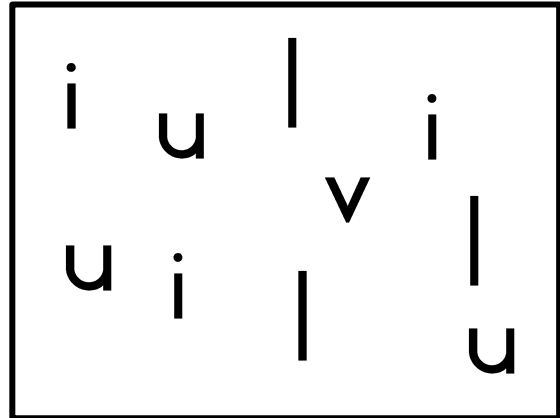

Practice writing the letter.

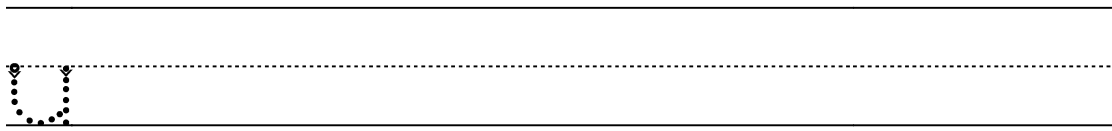

Trace the words.

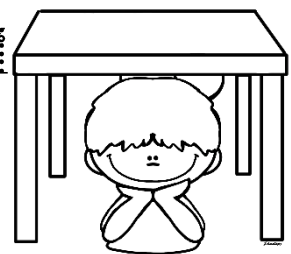
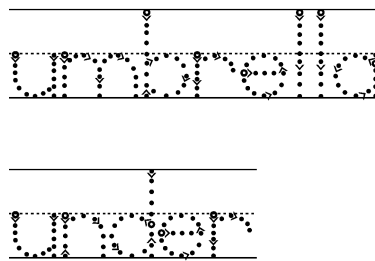
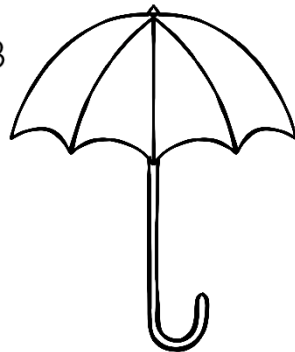
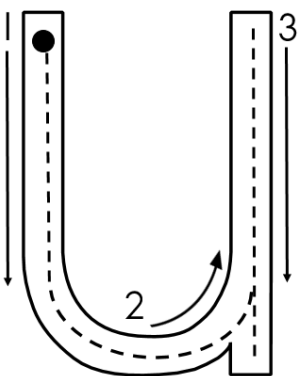

Practice writing the capital letter.

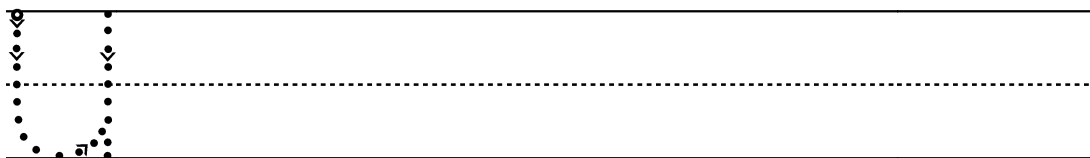

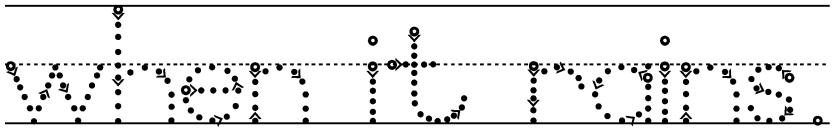
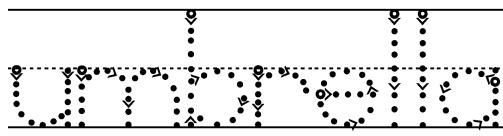
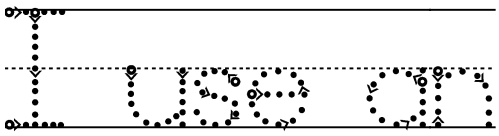
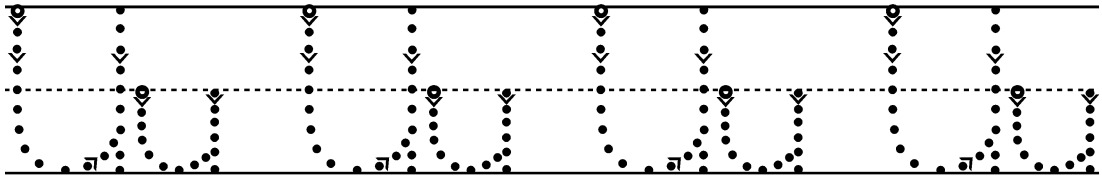
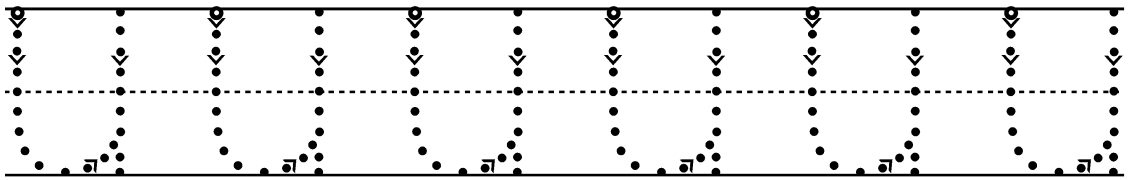
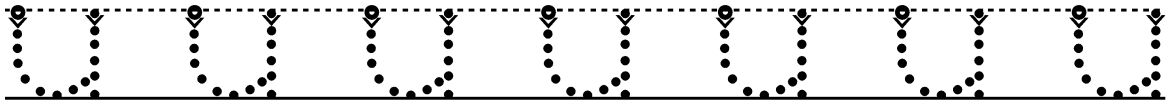
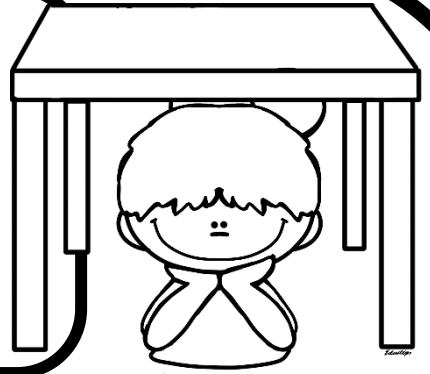
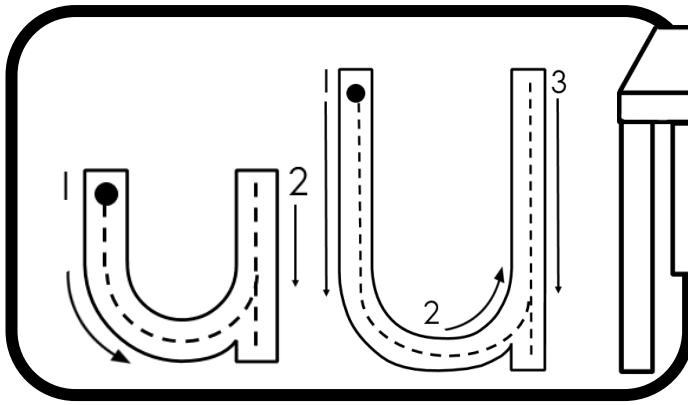

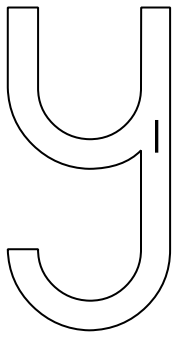

Colour the letter.

l - purple

Read the words.

|     |        |         |
|-----|--------|---------|
| you | yarn   | yolk    |
| yes | yellow | yoghurt |

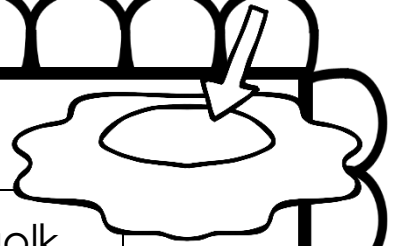

Trace the letter.

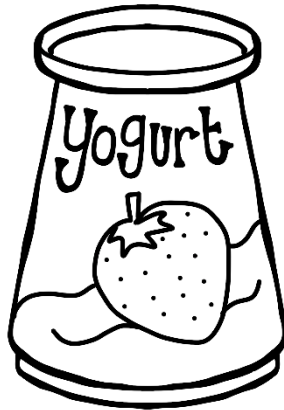
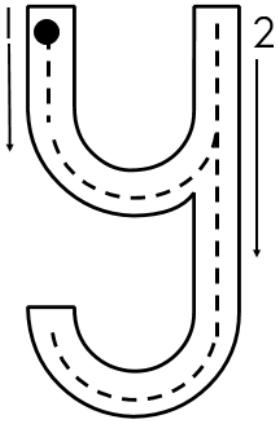

Circle all the "y" sounds.

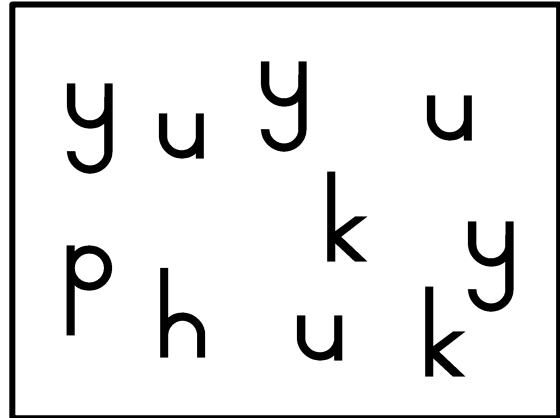

Practice writing the letter.

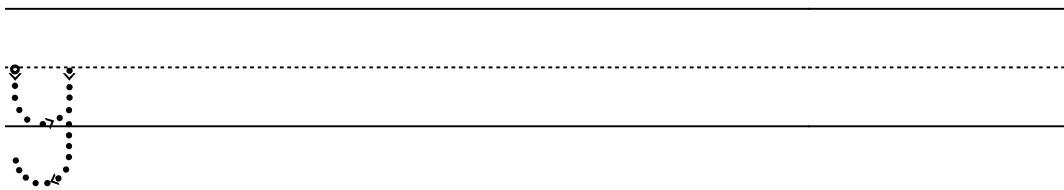

Trace the words.

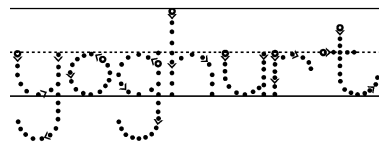
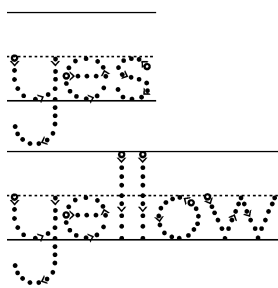
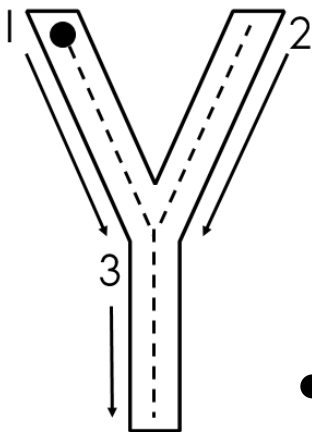

Practice writing the capital letter.

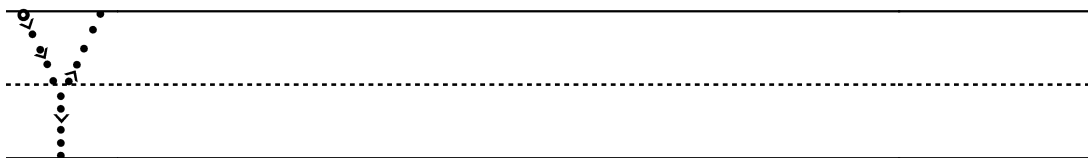



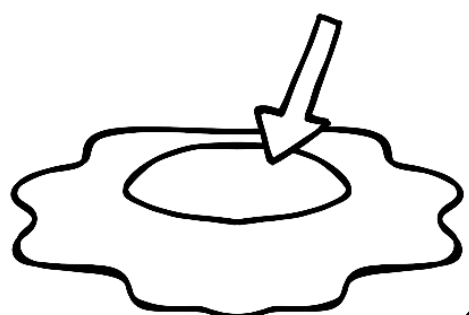
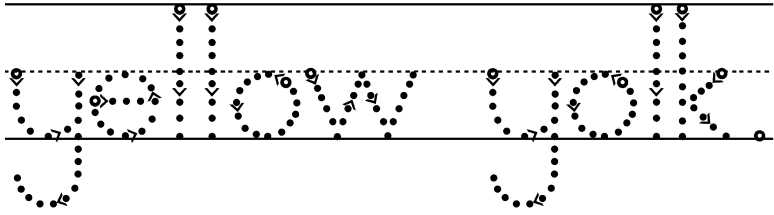
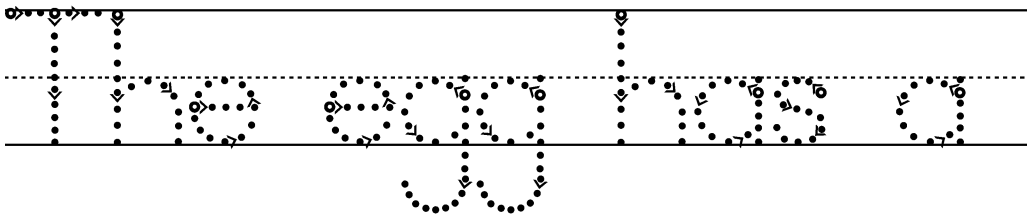
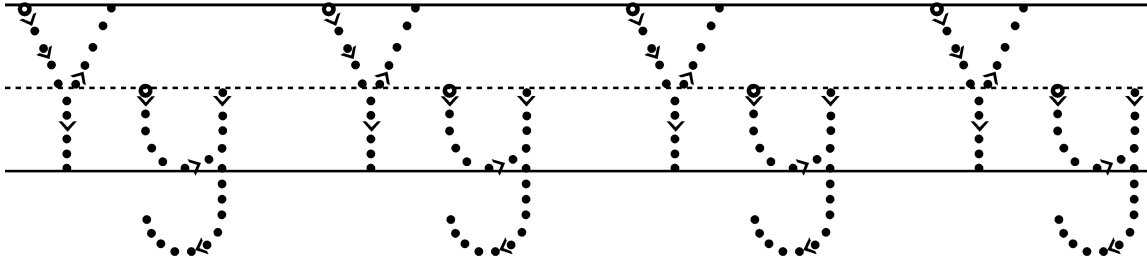
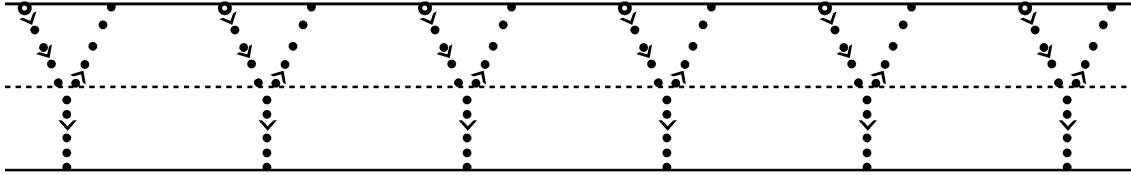
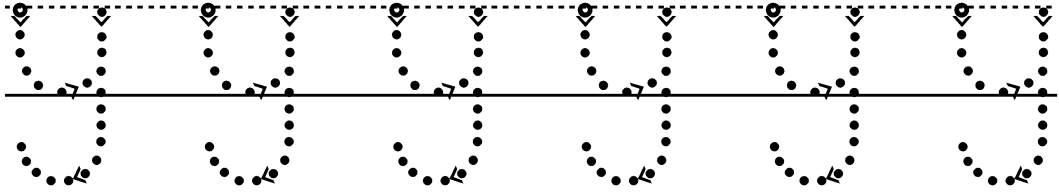
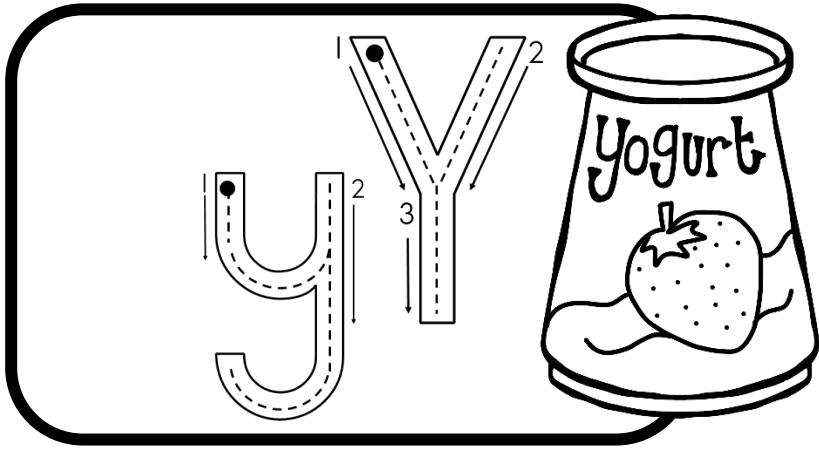

# Rhyming words.

Colour the pictures that rhyme with the first picture.

Rhyming words are words that sound the **same**.

