

Grade /  
English  
First Additional Language

Term /



h h h

h h h h h

o o

o o o o o

A A

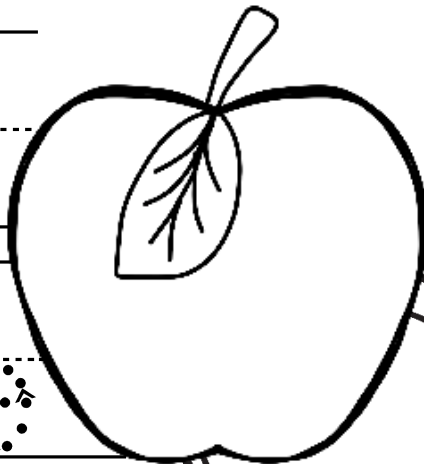

o o o o o

Name:

My name is:

\_\_\_\_\_

-----

\_\_\_\_\_

Draw the candles on the cake to show how old you are.

The first letter of my name is:

A J D B  
G L O I E  
Q F C K H  
U M S N P  
Z X V W Y  
T R

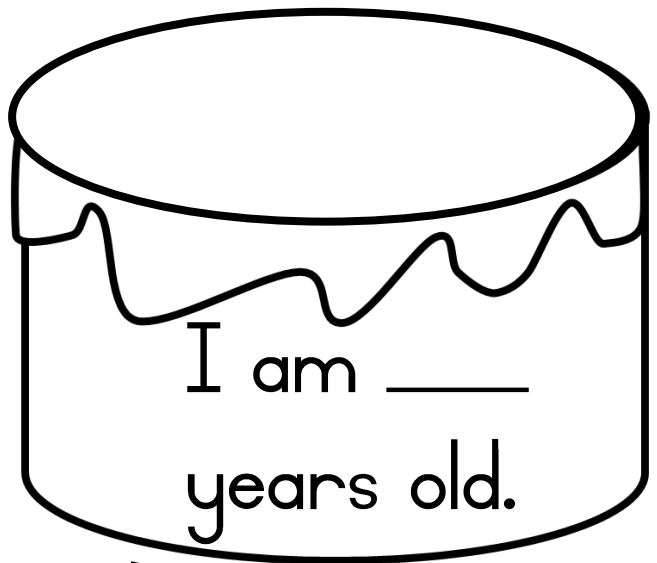

My favourite colour is:

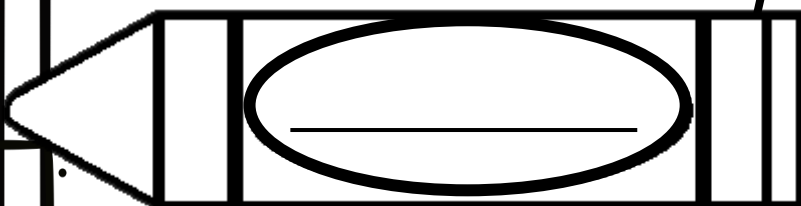

My fingerprint

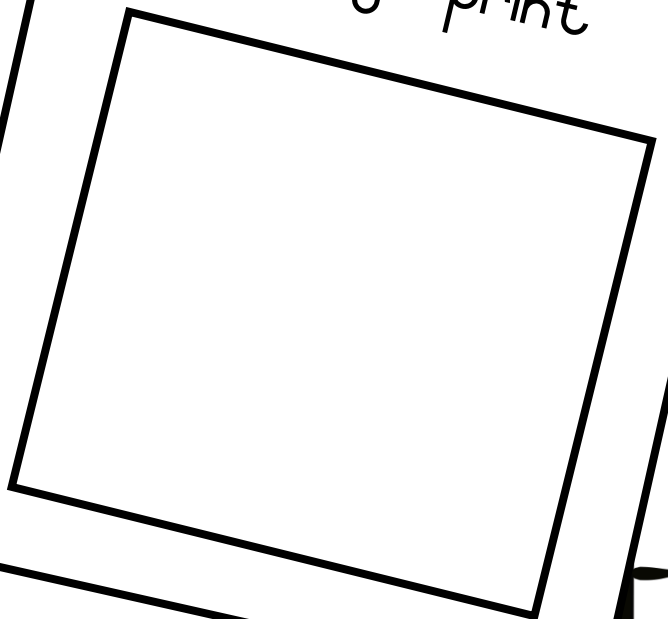

# My family

sister

brother

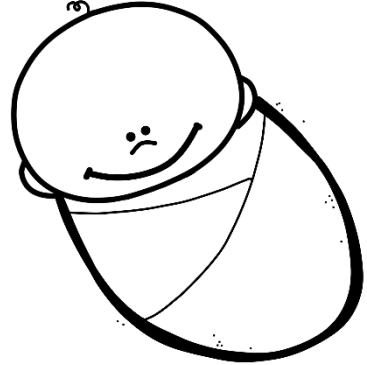
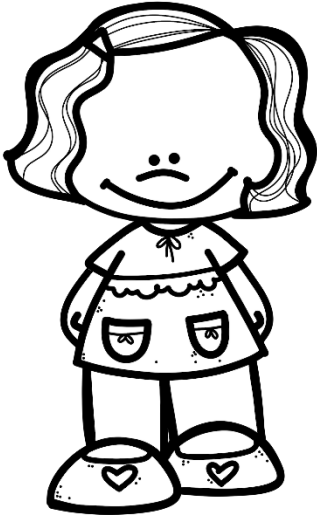

baby

mother

grandmother

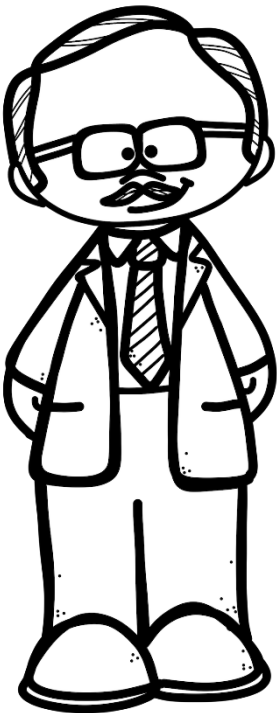

father

grandfather

# My family

Draw a picture of your family.

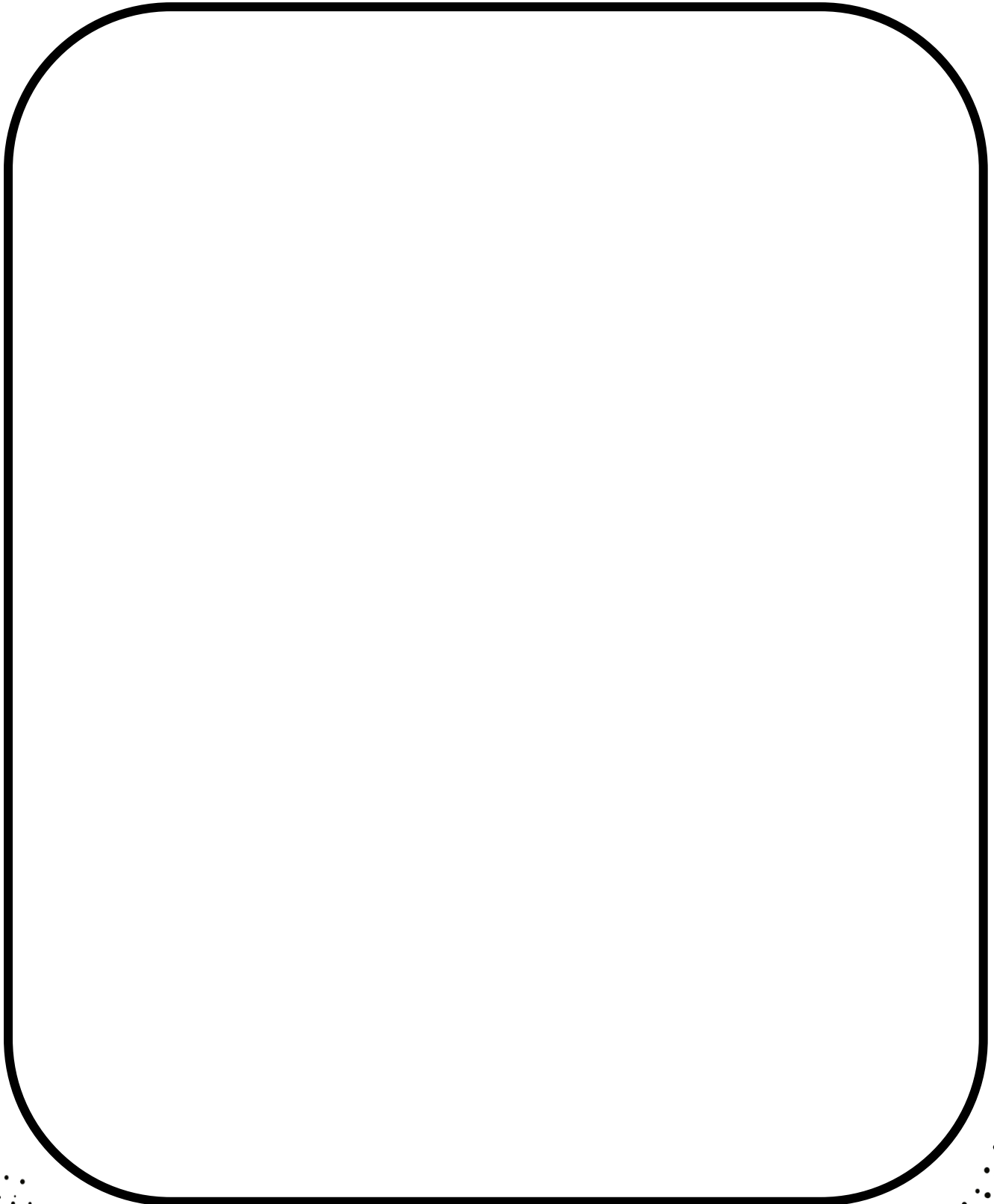

# My body

hair

head

eyes

arms

legs

stomach

big

toes

foot

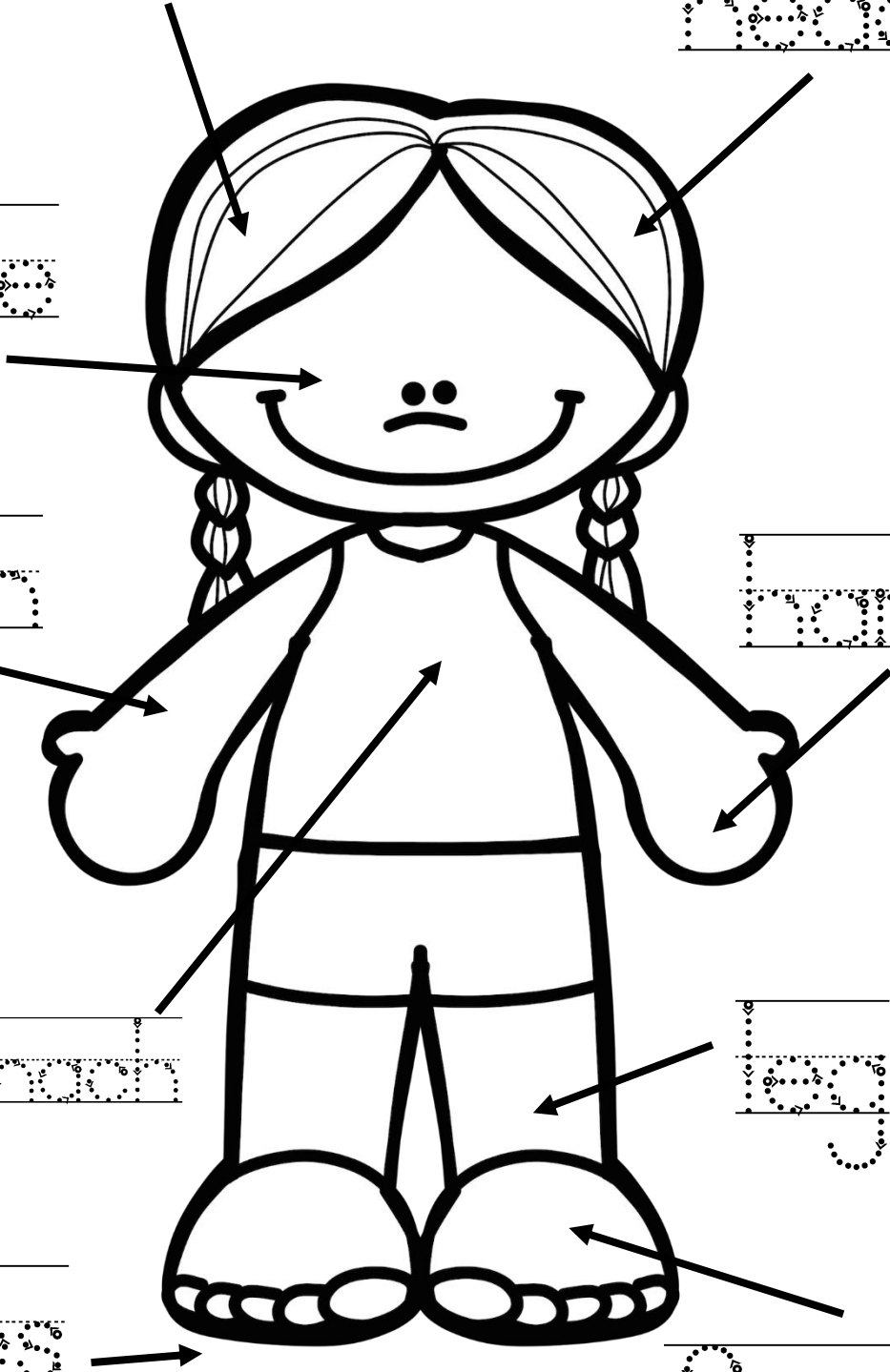

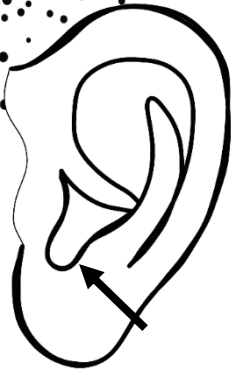

ear

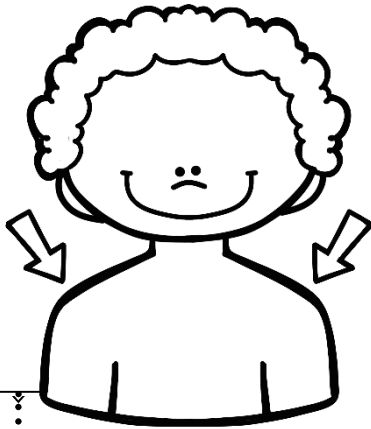

shoulders

foot

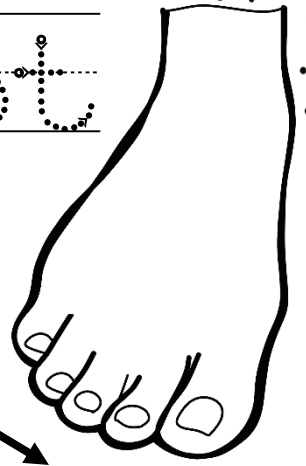

toes

finger

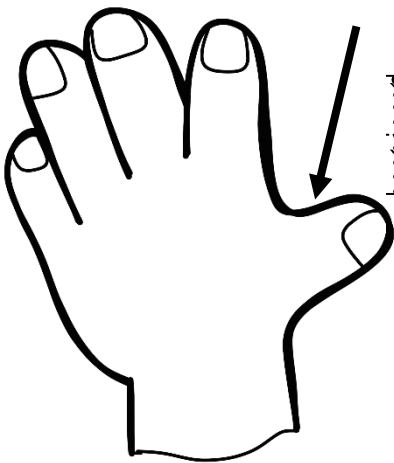

thumb

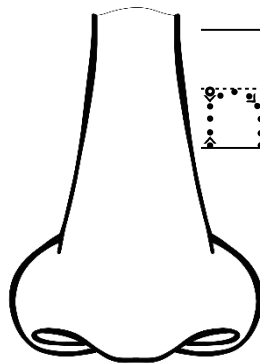

nose

arm

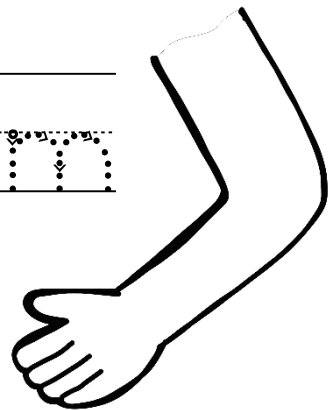

eye

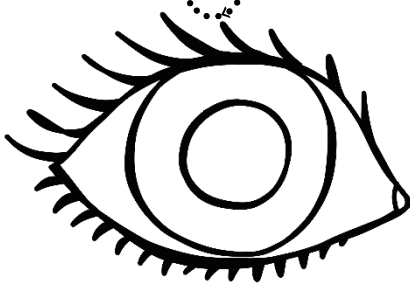

tooth

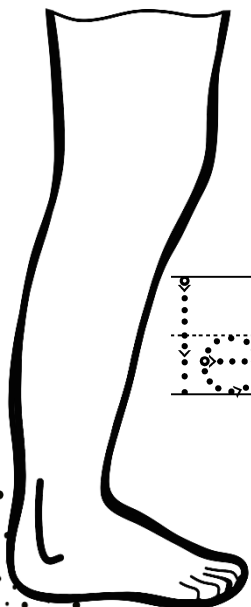

leg

mouth

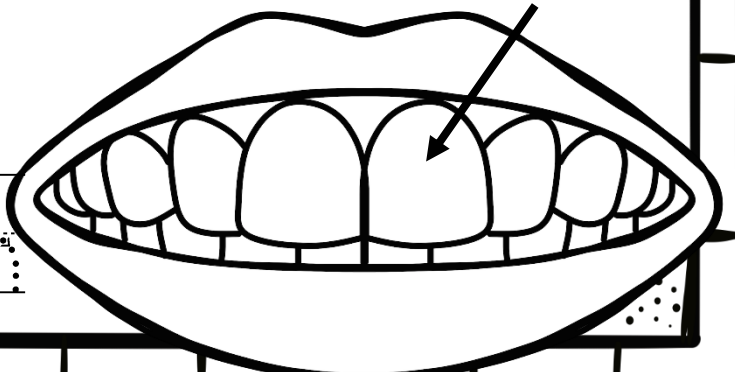

# Numbers 1 to 10

1

one

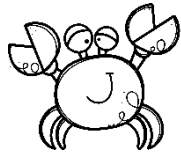

2

two

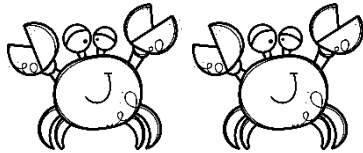

3

three

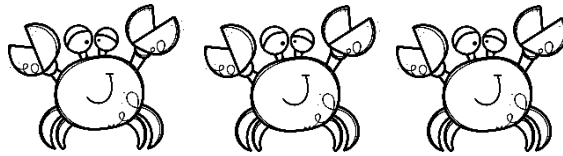

4

four

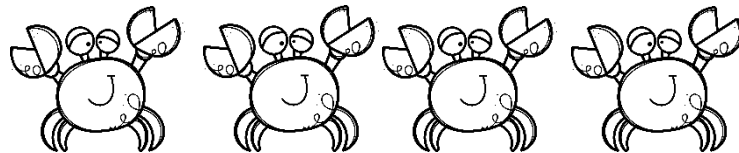

5

five



6

six



7

seven



8

eight



9

nine



10

ten



Complete the numbers in the sea stars.

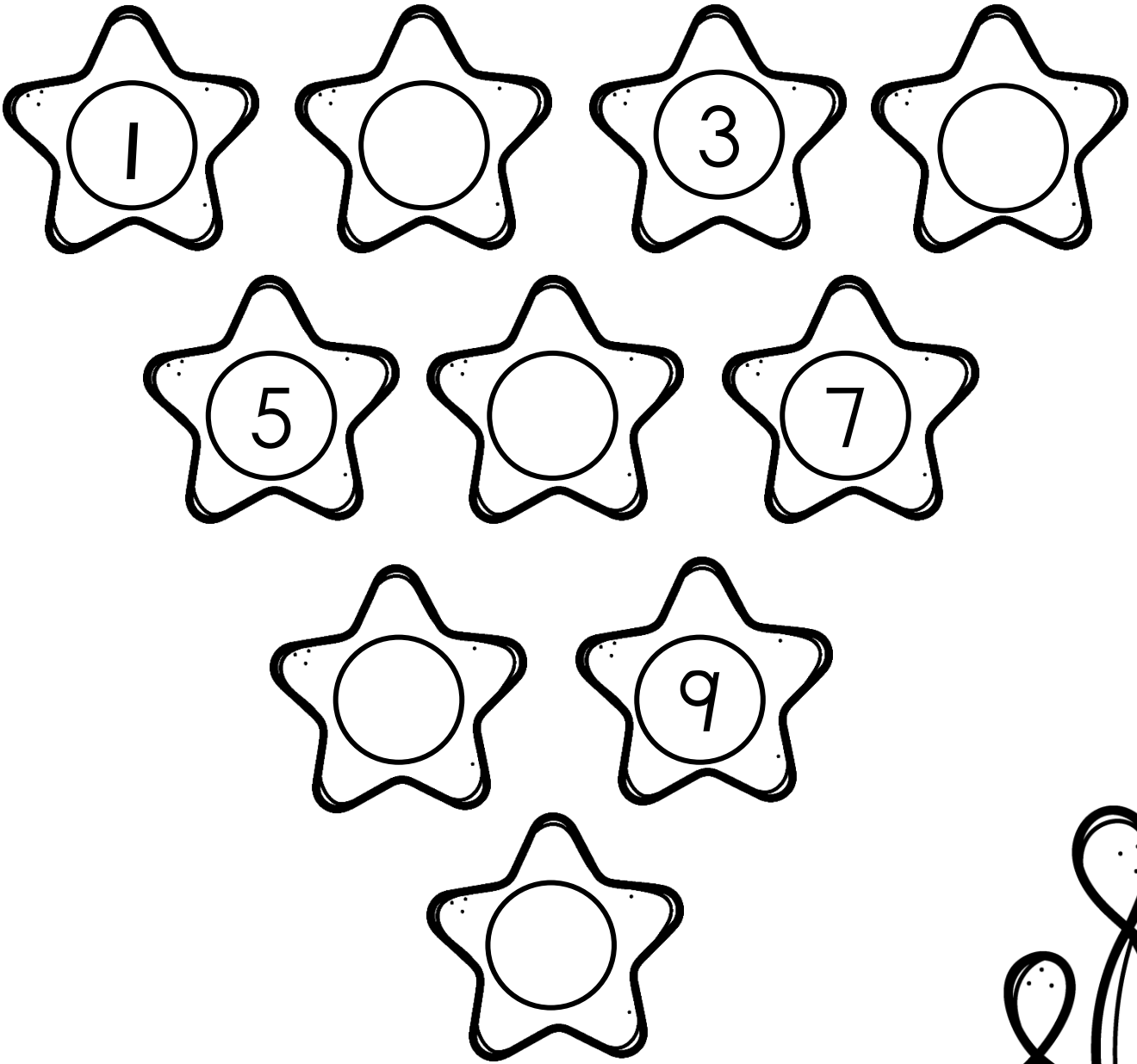

Practice the words.

one	two	three	four	five
six	seven	eight	nine	ten

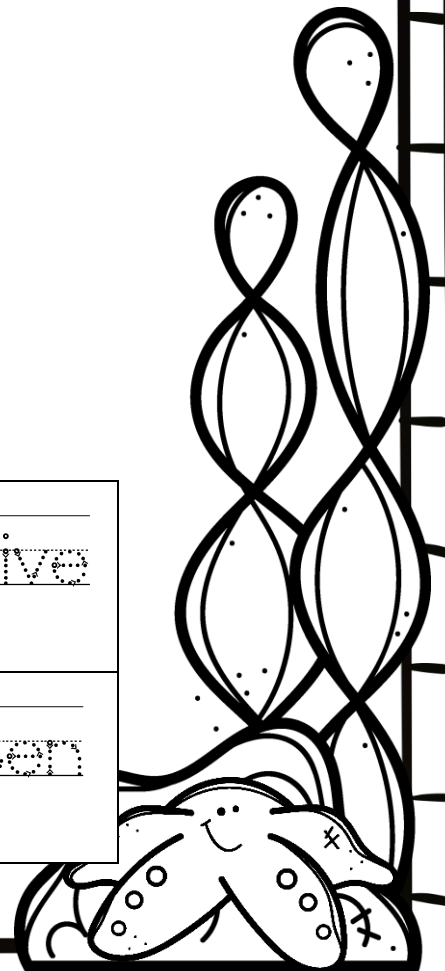



Match the number with the correct amount of pictures by drawing a line.

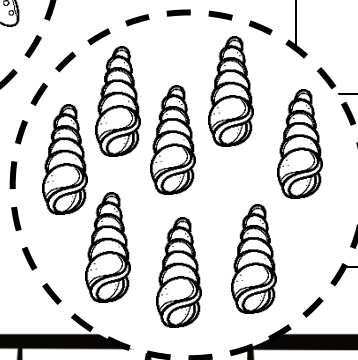
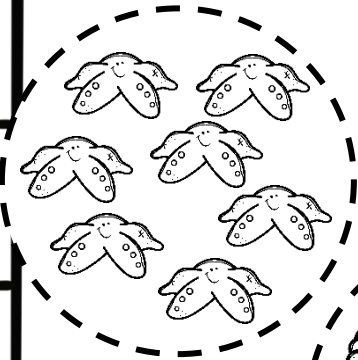
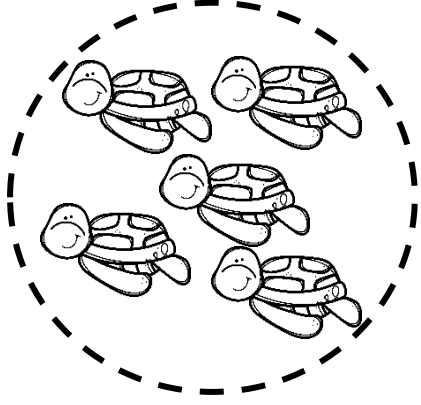
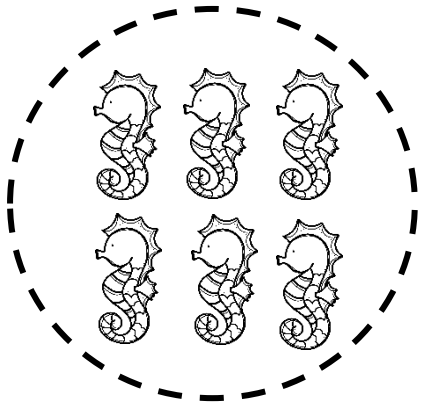
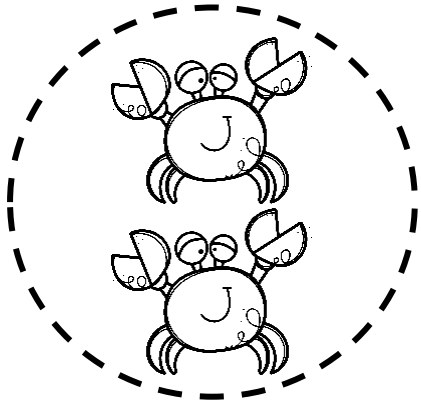

1
2
3
4
5
6
7
8
9
10

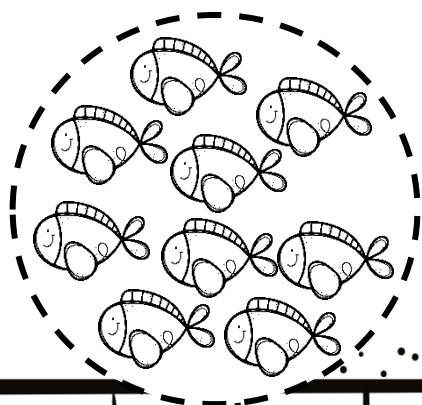
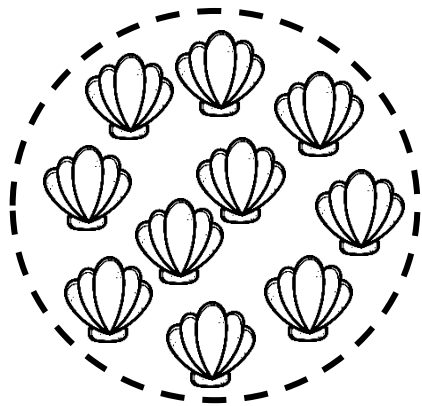
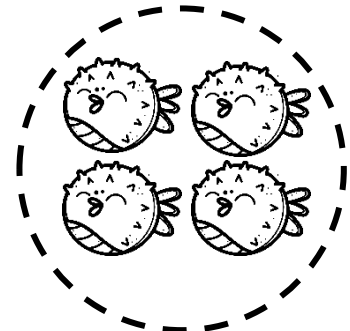
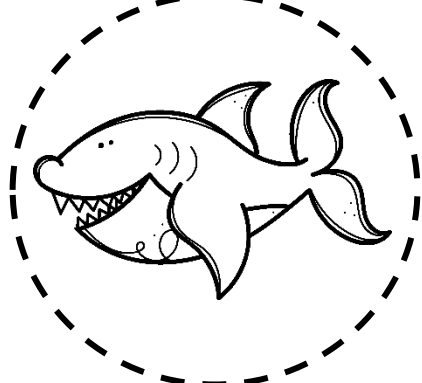
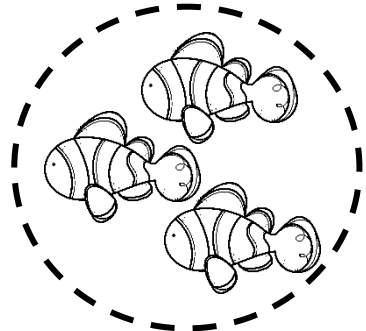

Trace and read the words.  
Colour the pictures the correct colour.

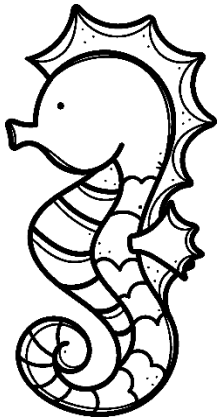

seahorse

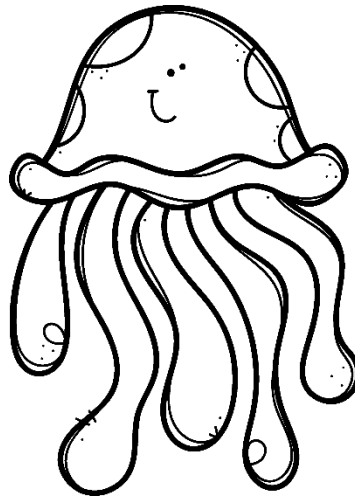

jellyfish

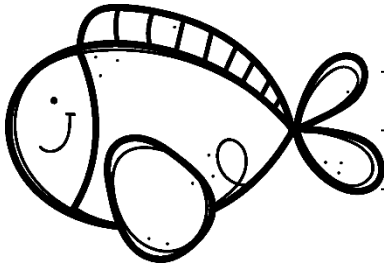

clownfish



pufferfish

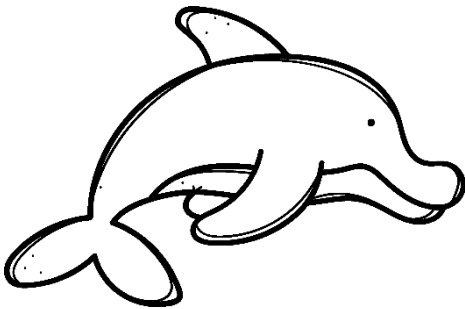

dolphin

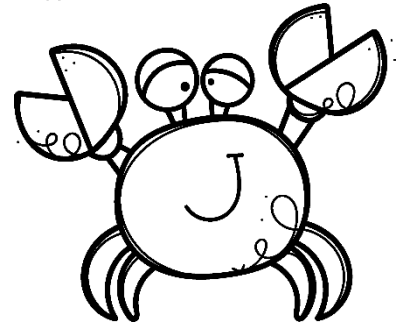

crab

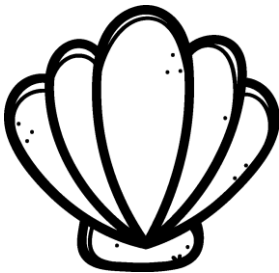

seashell



squid

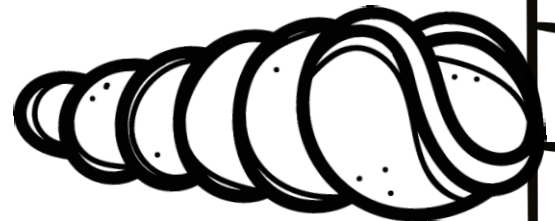

nautilus

# Insect fun

Help the insects to get to the flower.

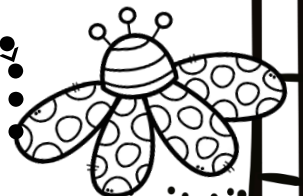
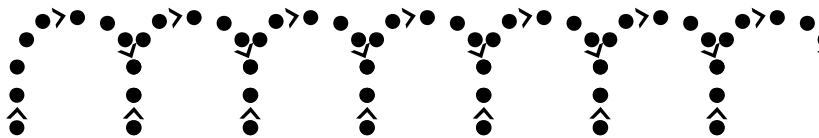
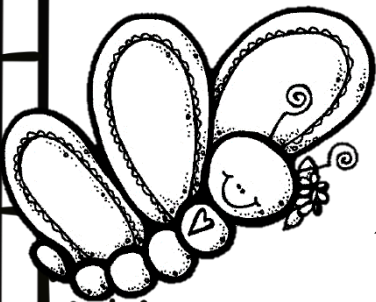
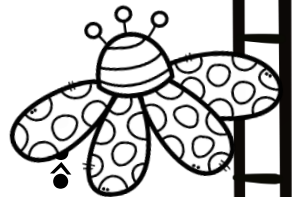
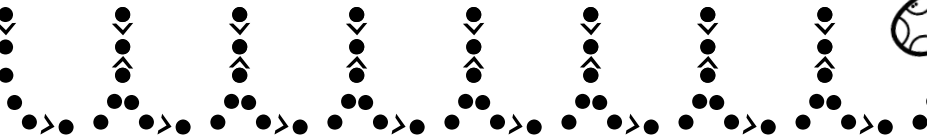
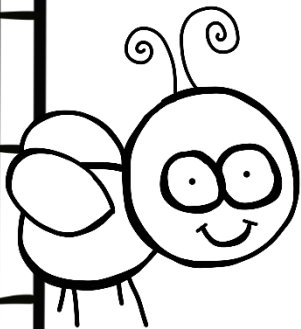
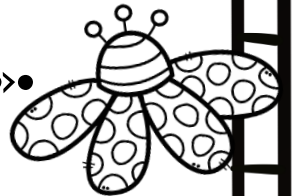
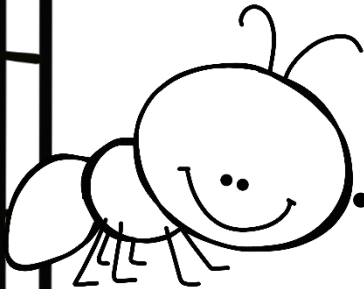
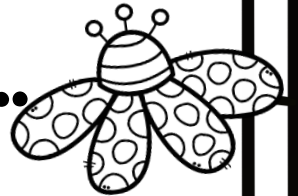
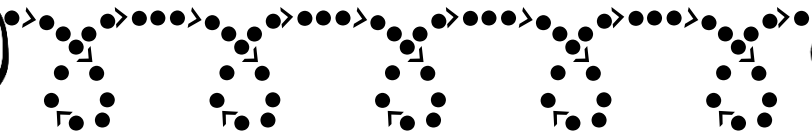
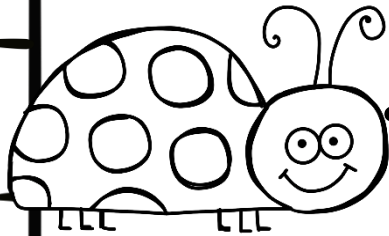
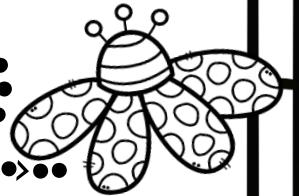
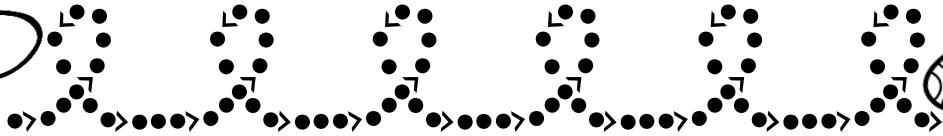
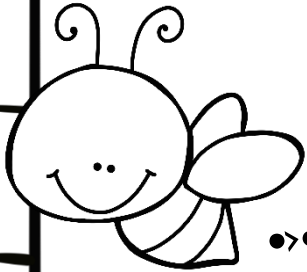



Hop like a rabbit to reach the carrot.

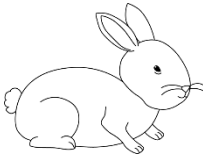
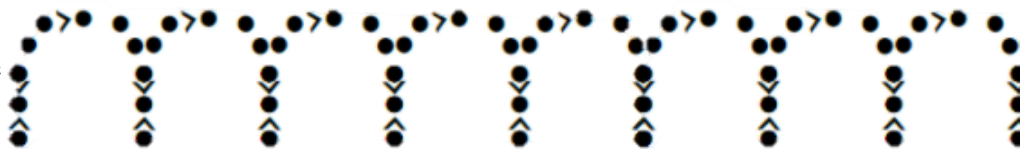
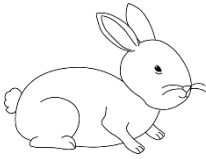
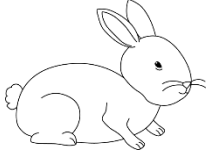

Hop like a frog.

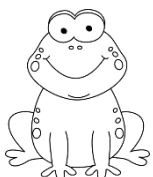
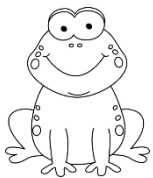
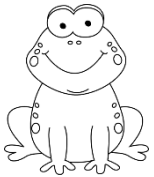
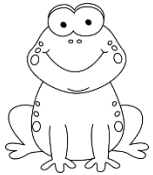



Swim like a dolphin  
over the waves.



---

Complete the rest of the line with waves.



Gallop like a horse.



---

Complete the rest of the line.

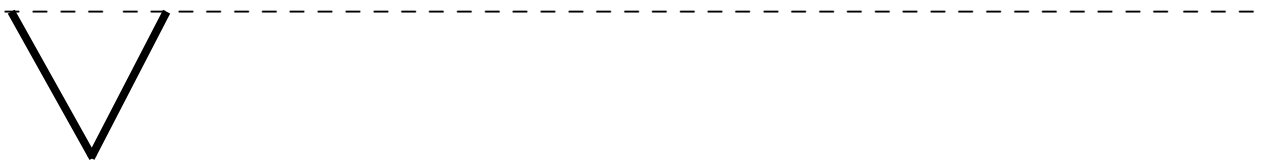

# Monkey swing

Show the monkey how to swing by completing the pattern.

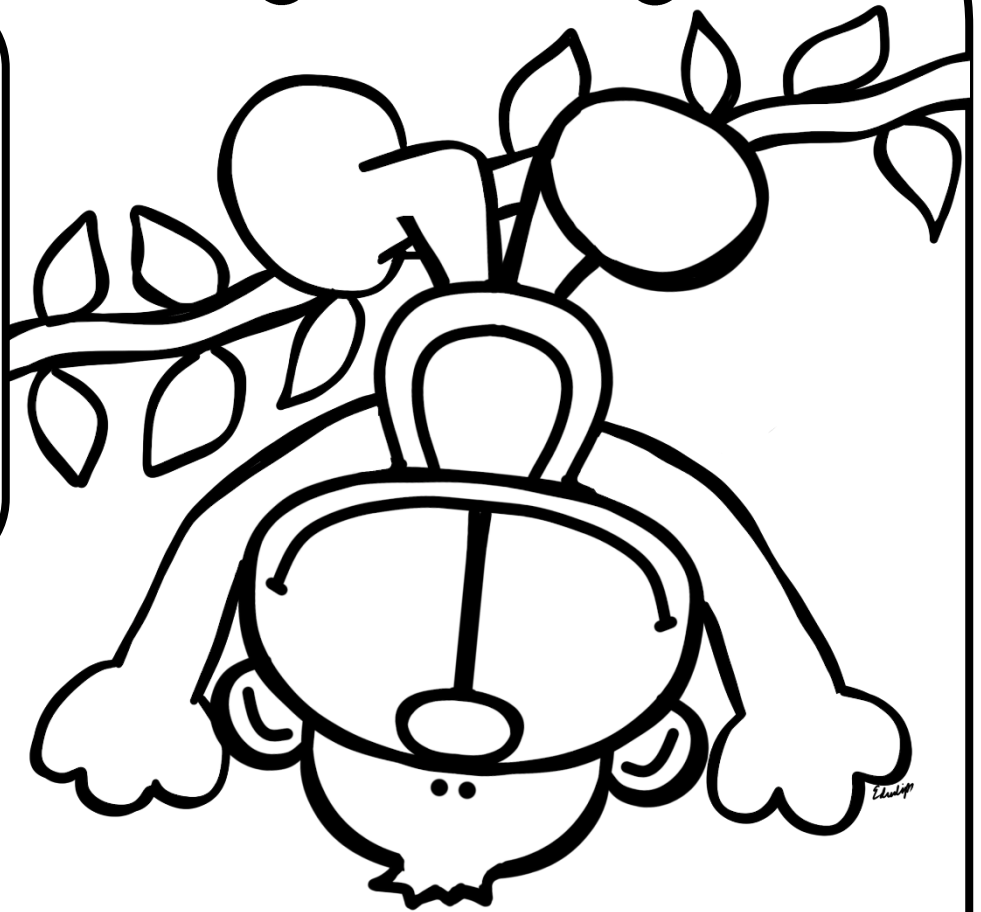

Swing with Tarzan  
through the woods.





Colour the pictures that begins with the sound.

a

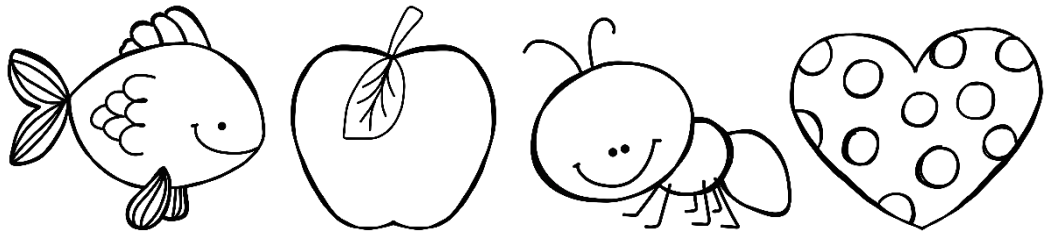

s

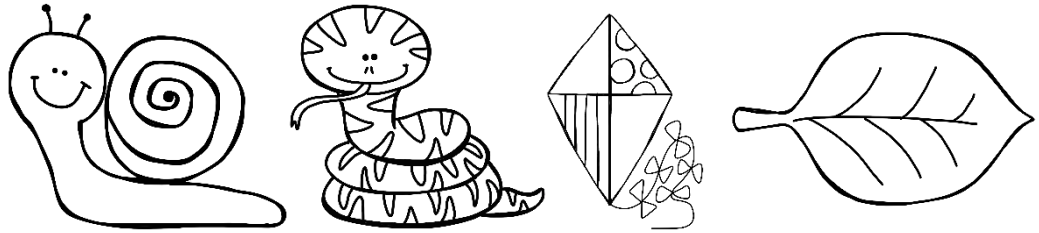

b

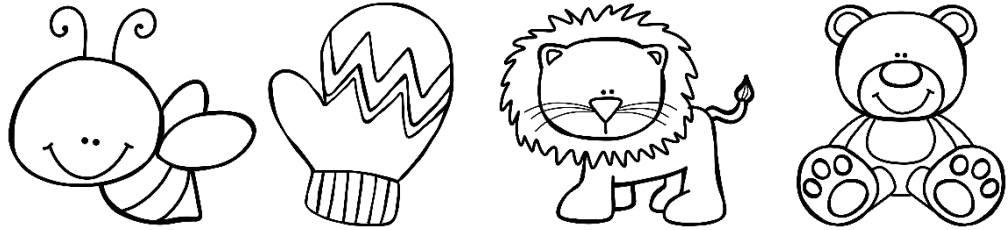

m

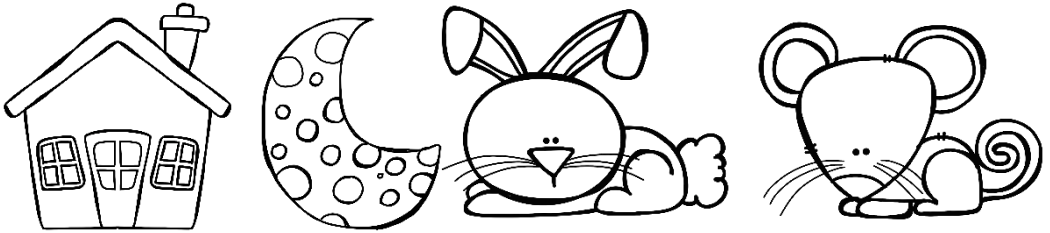

k

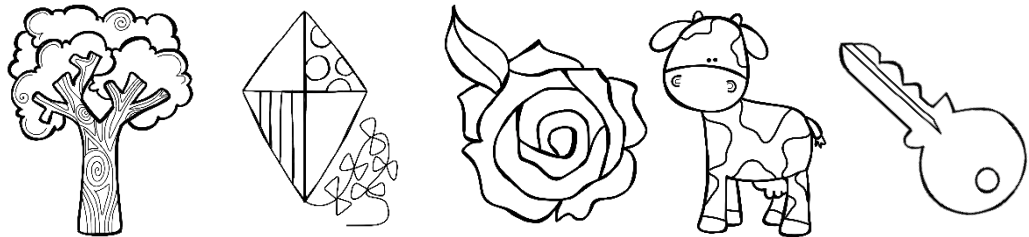

e

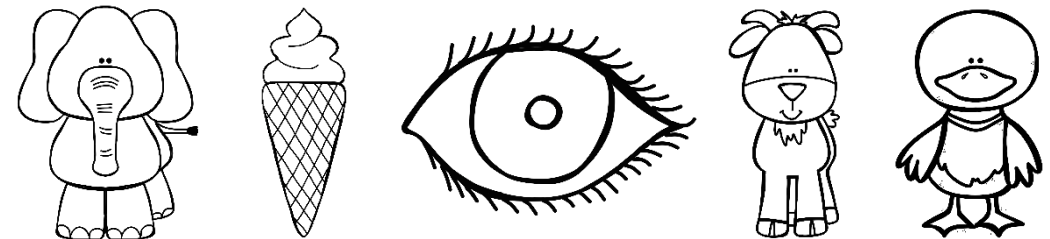

a

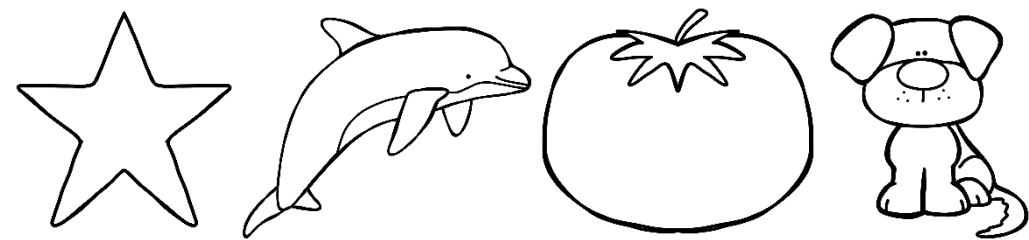

# Beginning sound

With which letter does the following words begin?

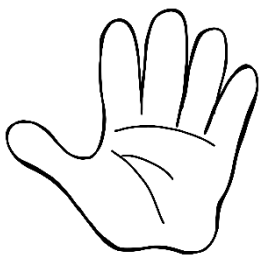
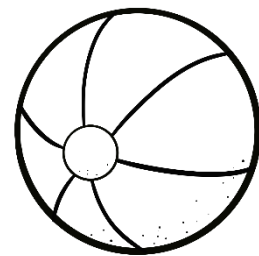
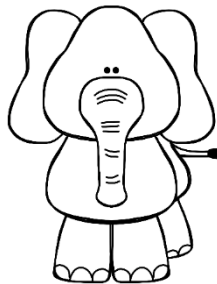
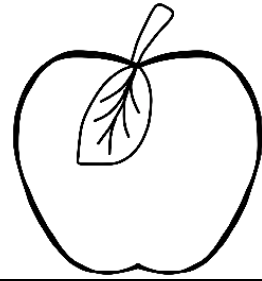
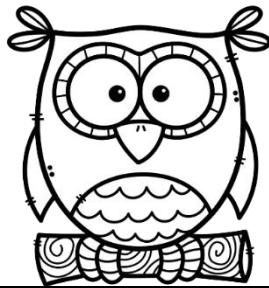
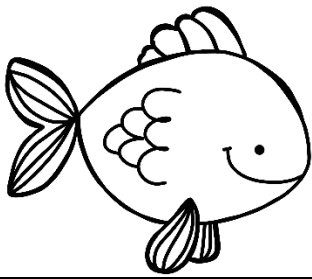
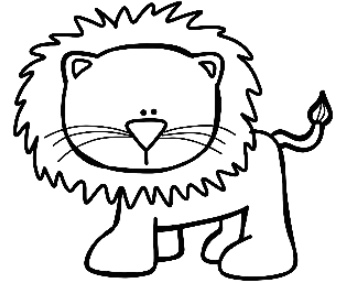
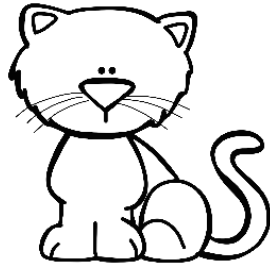

Colour the letter. 1 - red

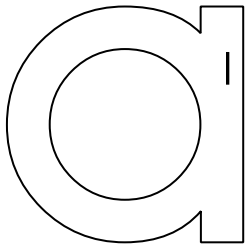

Read the words.

ant

apple

ape

anchor

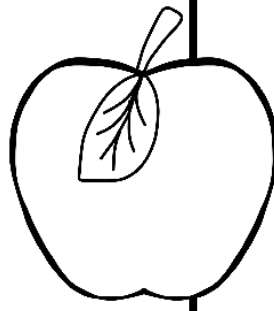
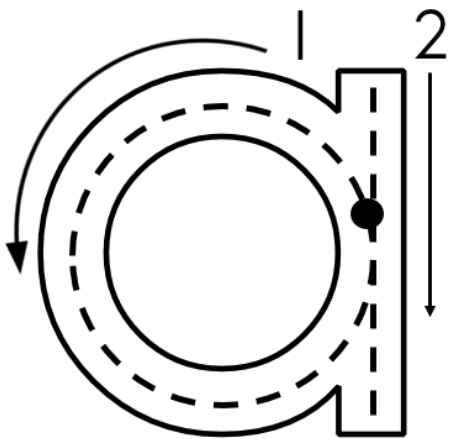

Circle all the "a" letters.

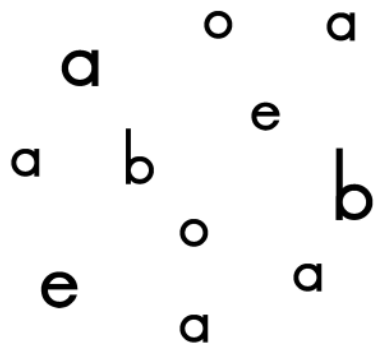

Practice writing the letter.

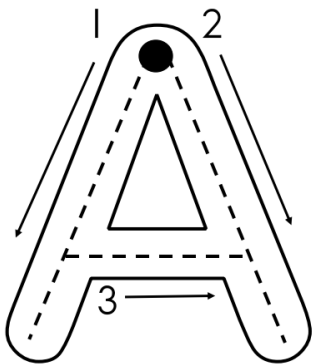
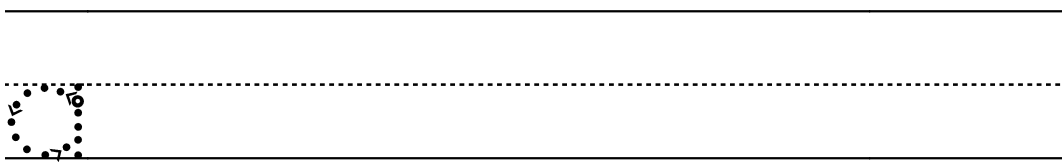

Practice writing the capital letter.

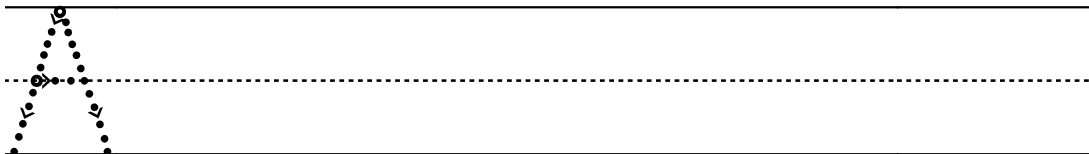

# "a" sound

Colour all the pictures that start with the "a" sound.

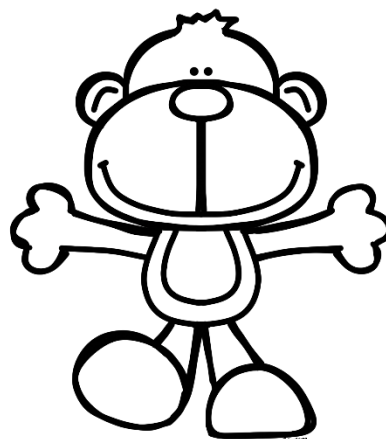
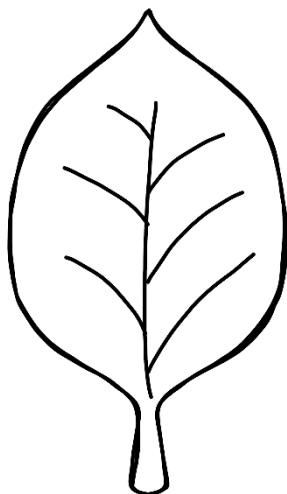
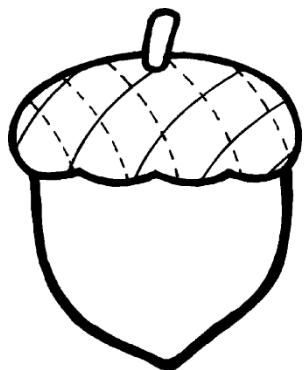
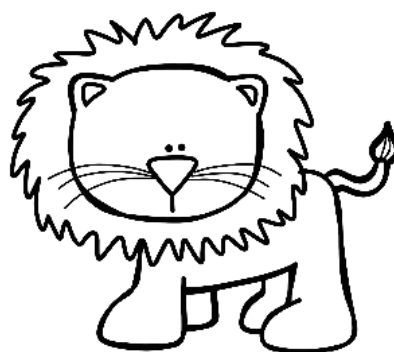
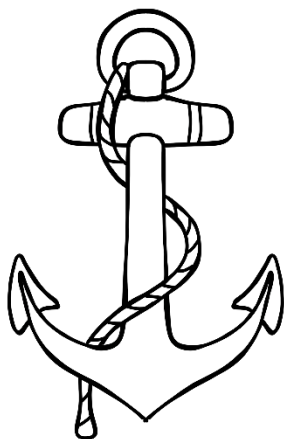
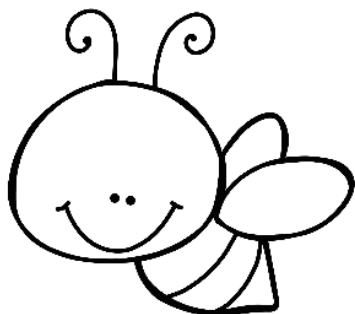
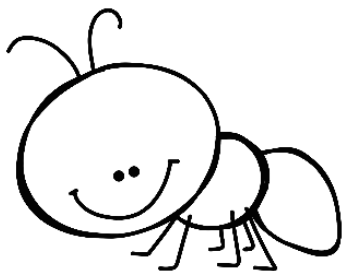
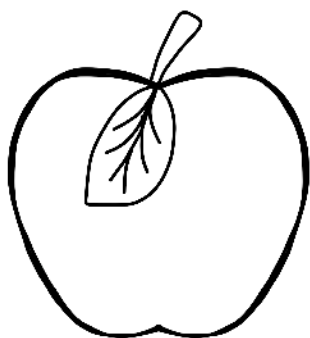

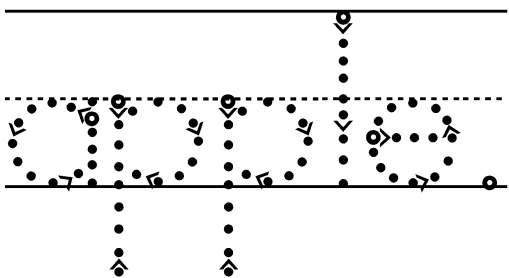
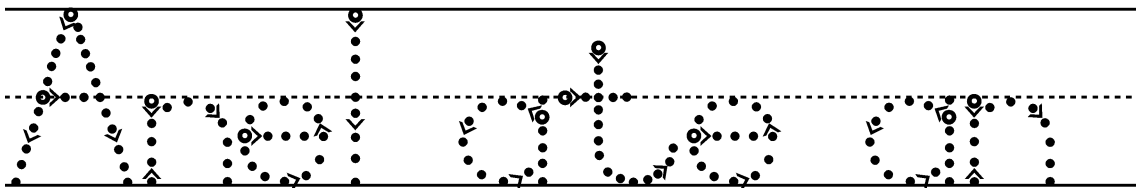
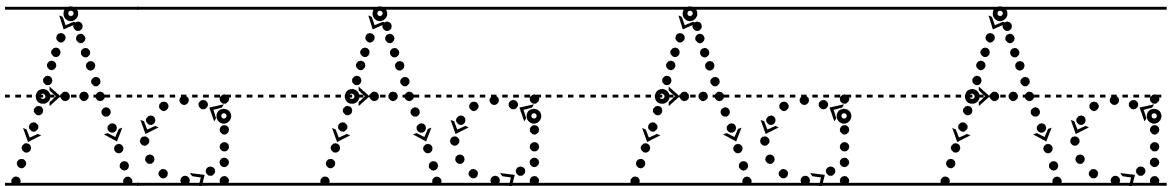
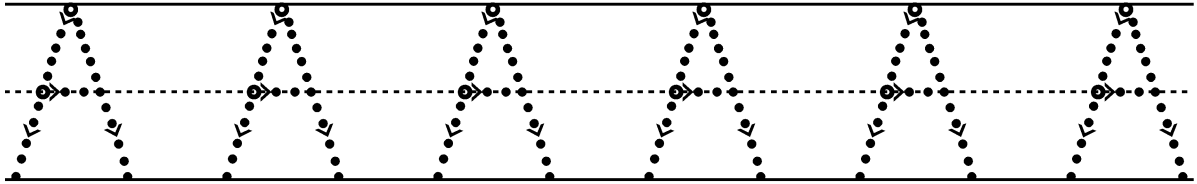
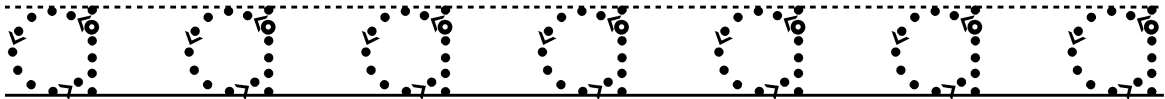
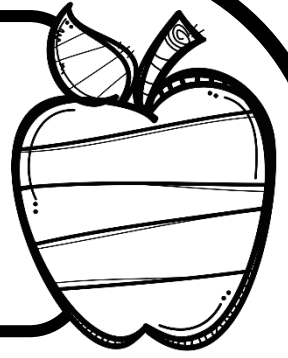
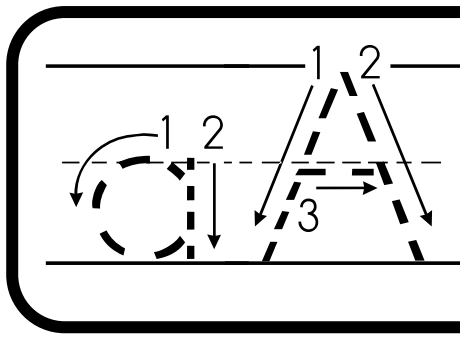

Colour the pictures that match the first one.

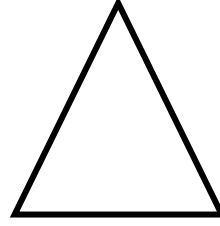
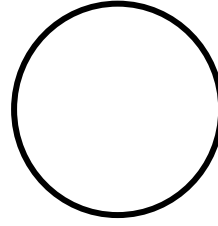
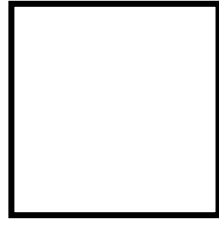
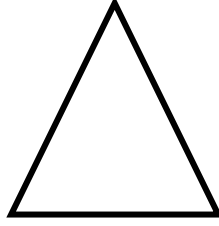
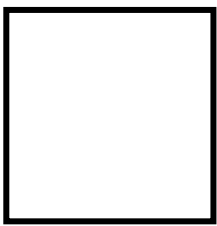
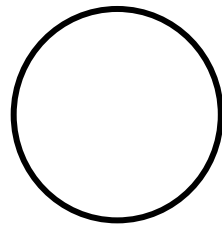
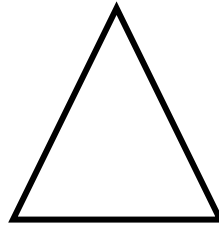
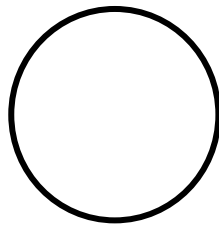
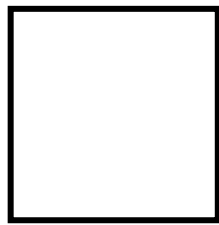
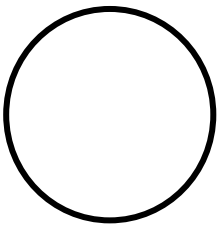
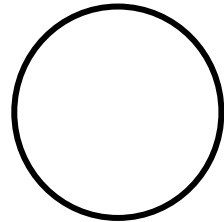
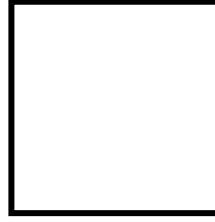
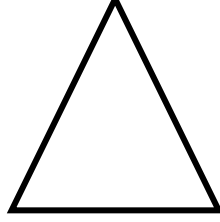
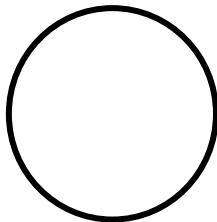
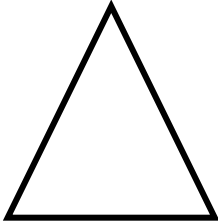
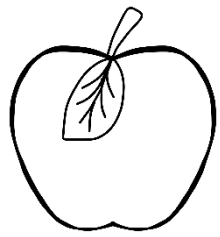
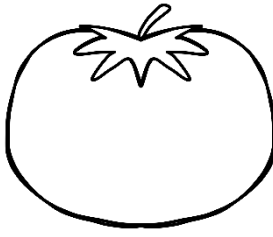
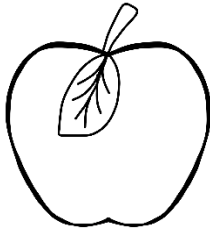
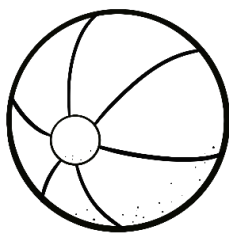
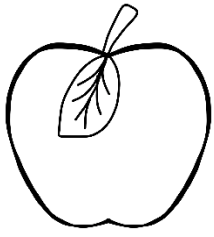

a

a

d

b

a

g

a

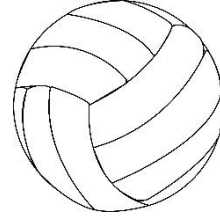
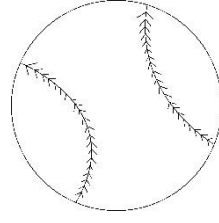
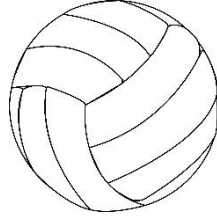
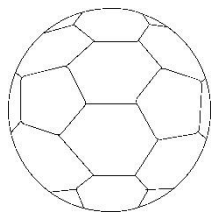
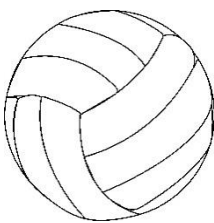

Colour the letter.

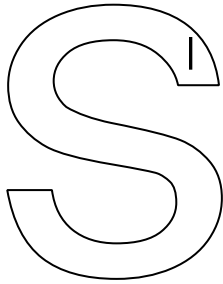

l - purple

Read the words.

say	sea	see	sad
sun	snail	snake	star

Trace over the letter.



Circle all the "s" letters.

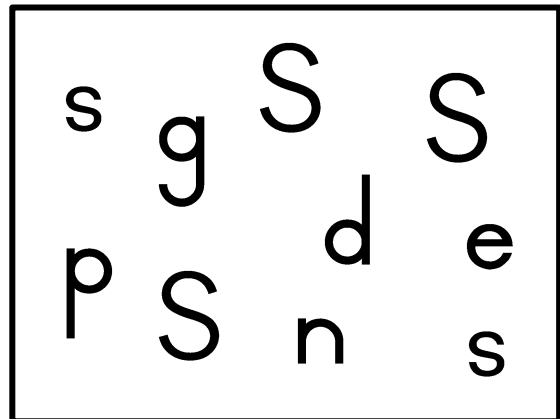

Practice writing the letter.

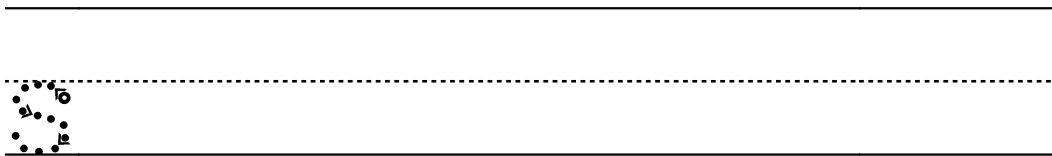

Trace the words.

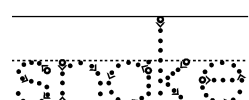
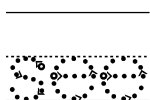
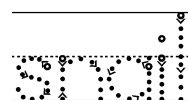
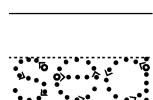
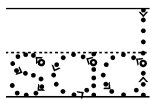

Practice writing the capital letter.

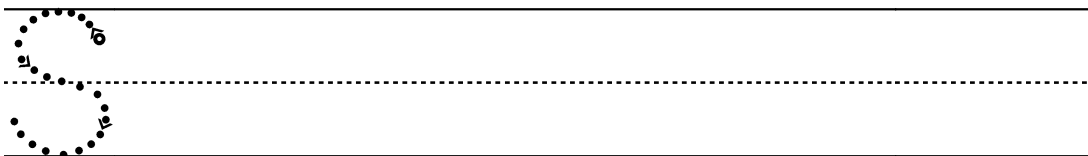

# "s" sound

Colour all the pictures that start with the "s" sound.

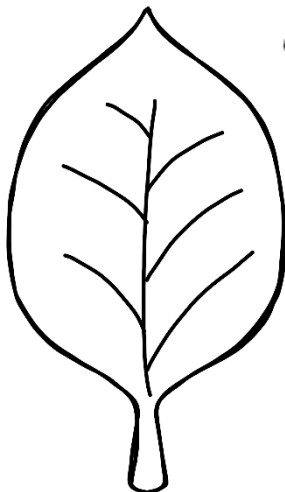
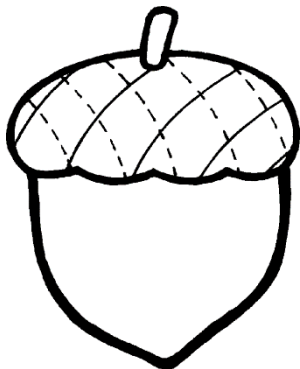
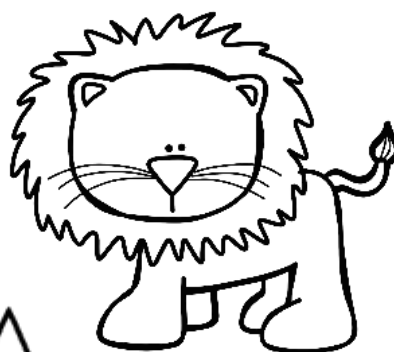
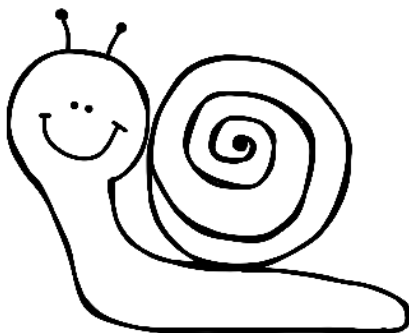
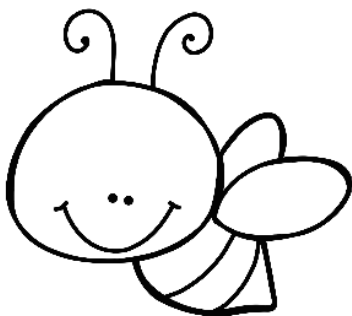
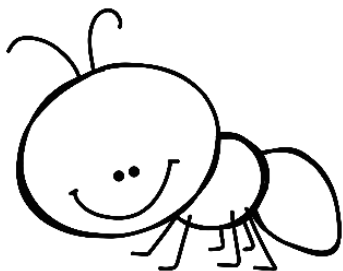
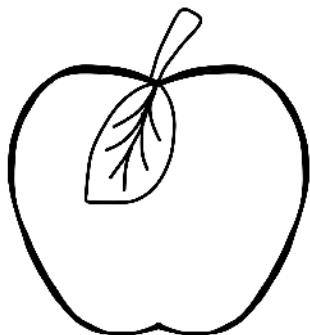



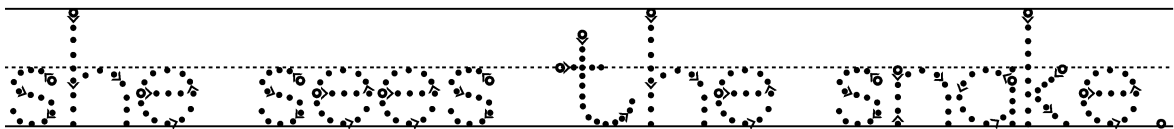
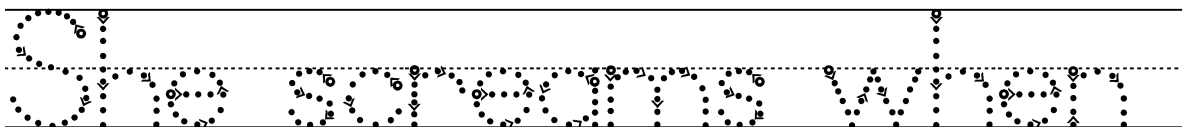
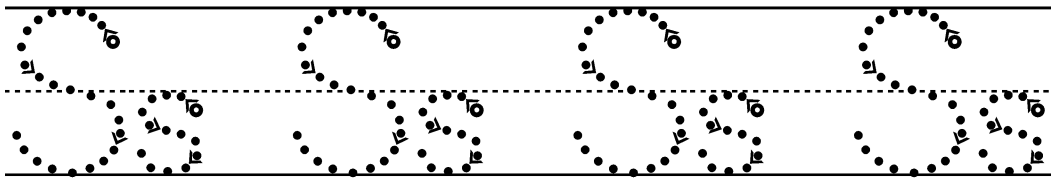
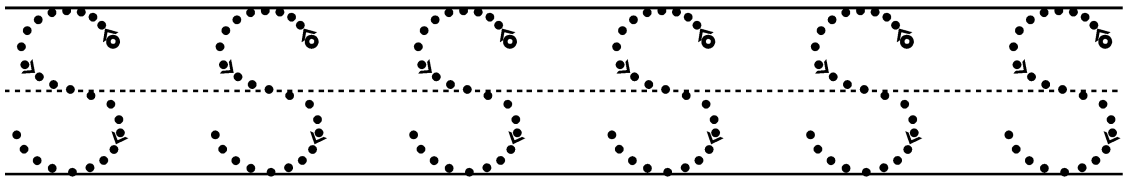
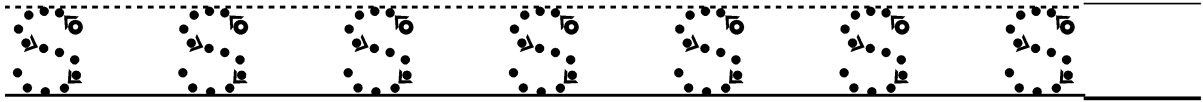
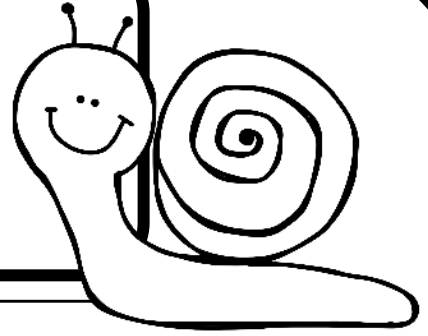
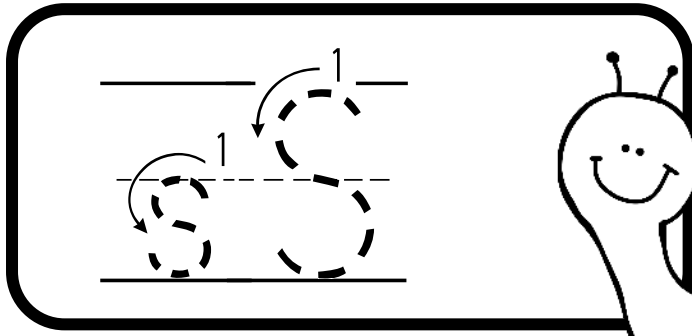

Colour the letter. | - blue

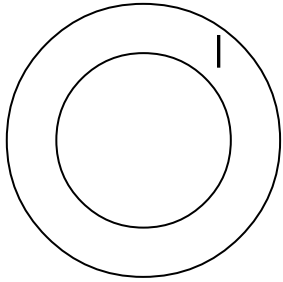

Read the words.

out	owl	onion
orange	octopus	

Trace the letter.

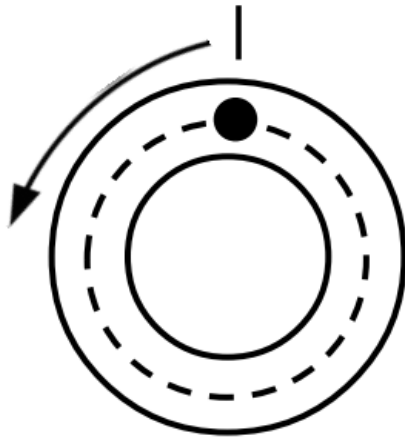

Circle the "o" letters.

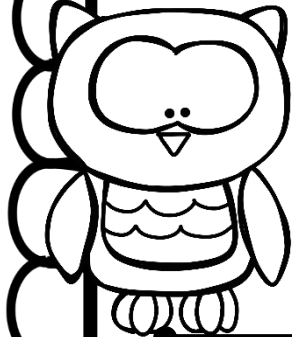
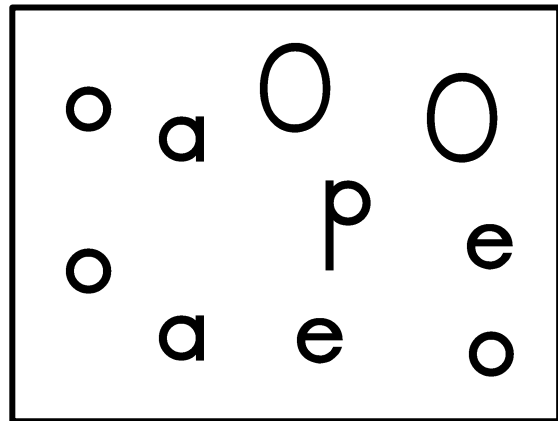

Practice writing the letter.

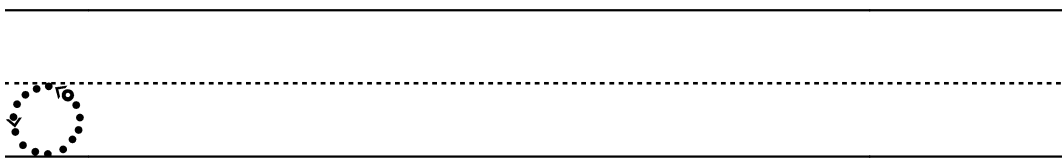

Complete the "o" sound in the words.

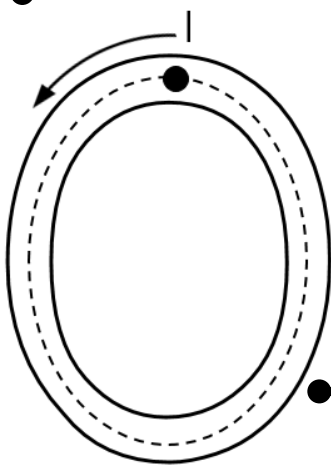

\_\_wl  
\_\_nion

d\_\_lphin  
\_\_ctopus

Practice writing the capital letter.

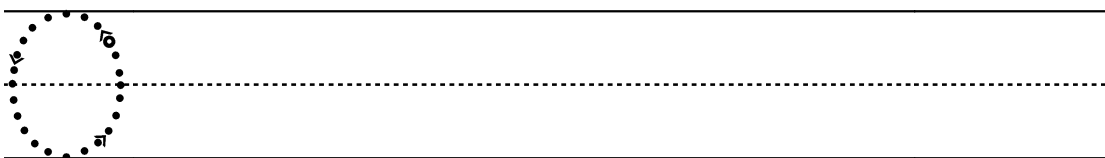

# "o" sound

Colour all the pictures that start with the "o" sound.

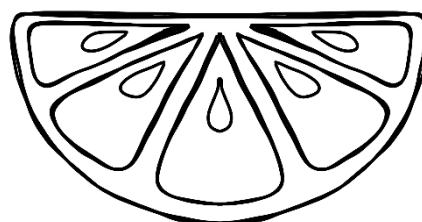
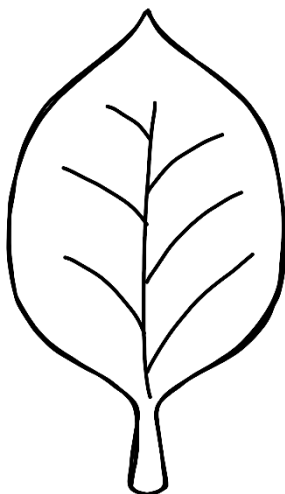
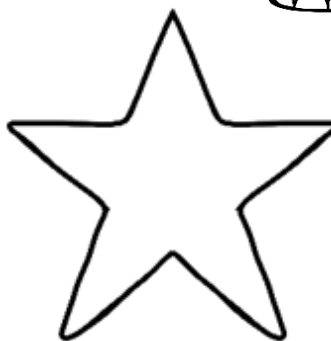
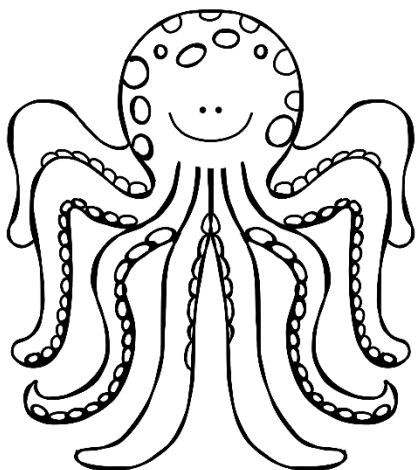
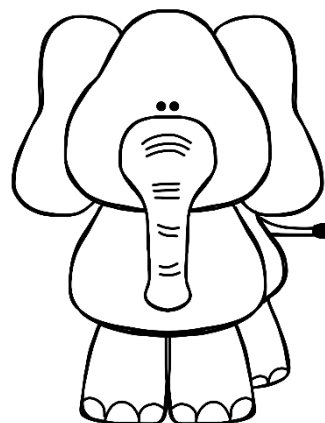
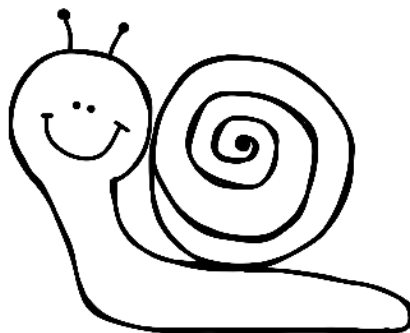
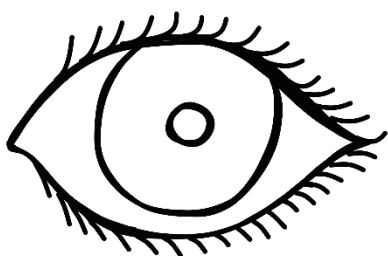
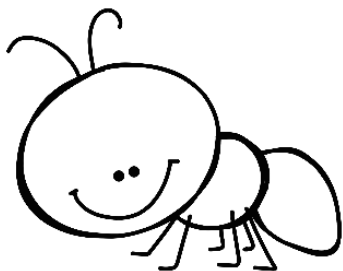
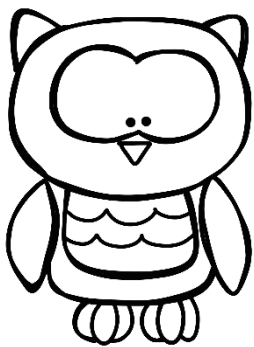

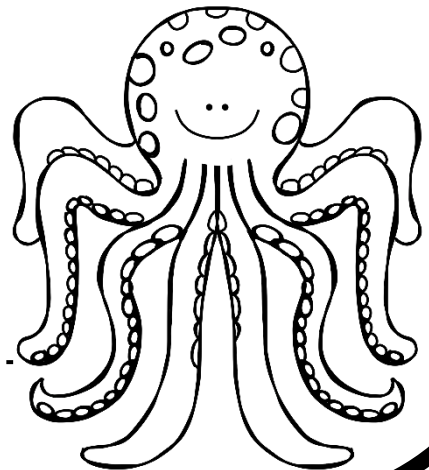
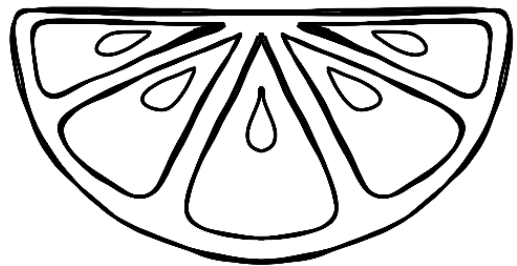
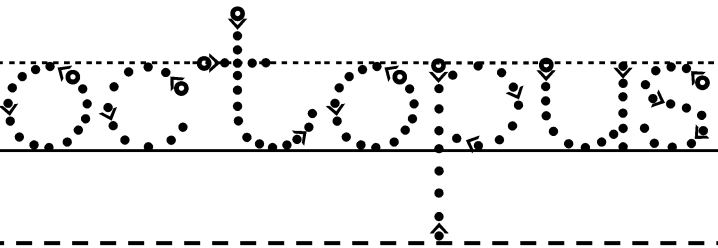
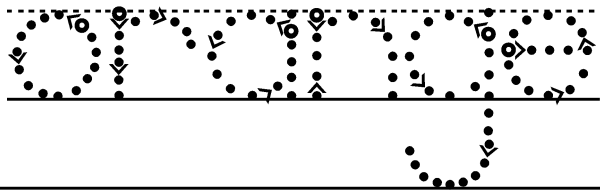
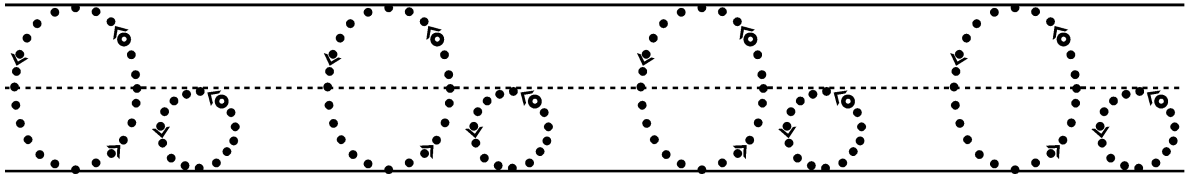
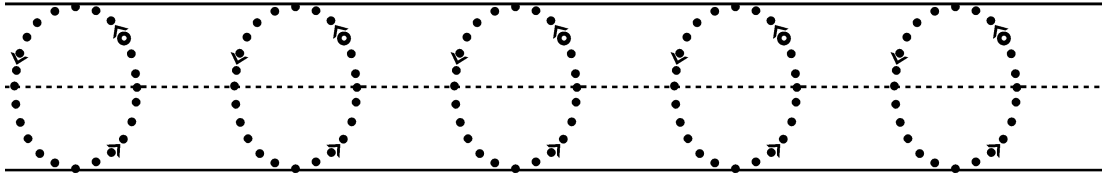
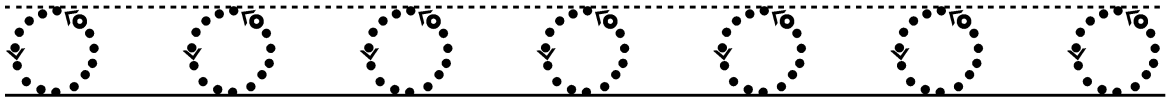
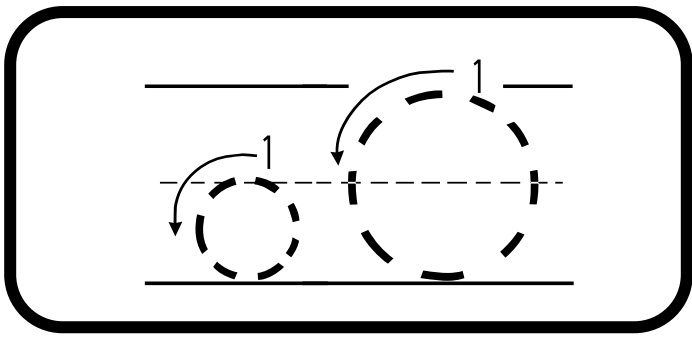

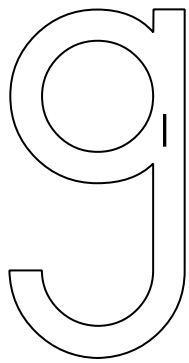

Colour the letter.

l - green

Read the words.

grass	glass	green	glue
goose	goat	girl	grapes

Trace the letter.

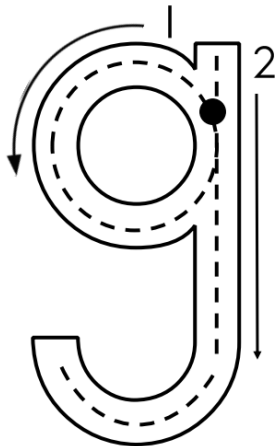
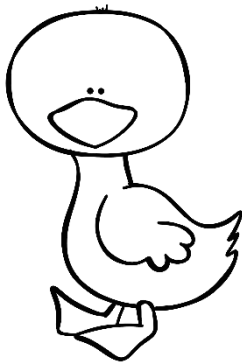

Circle the "g" sound.

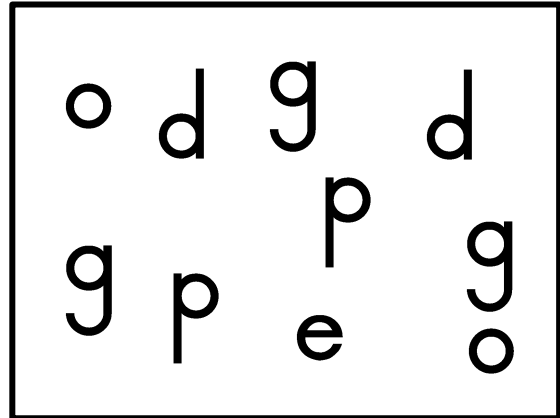

Practice writing the letter.

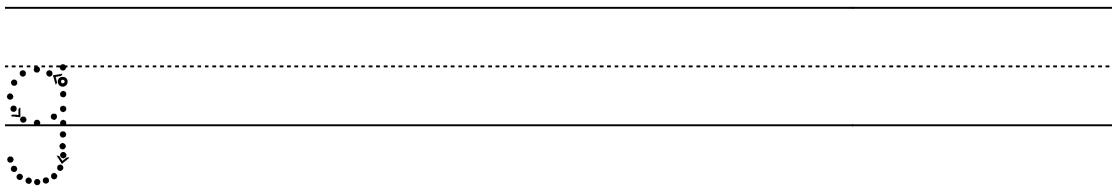

Complete the "g" sound in the words.

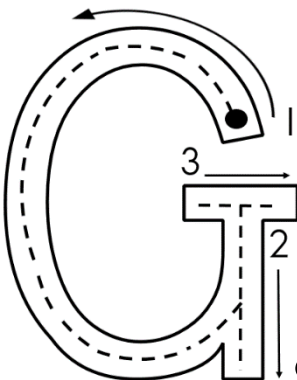

\_\_reen | \_\_rapes  
 \_\_rass | \_\_lass

Practice writing the capital letter.

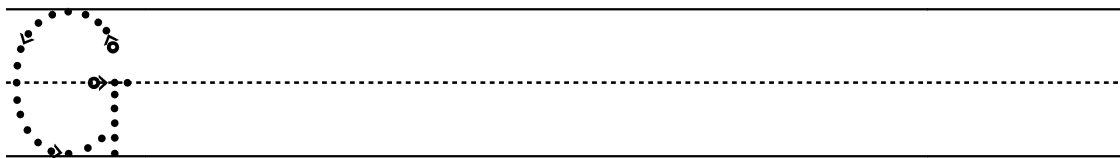

# "g" sound

Colour all the pictures that start with the "g" sound.

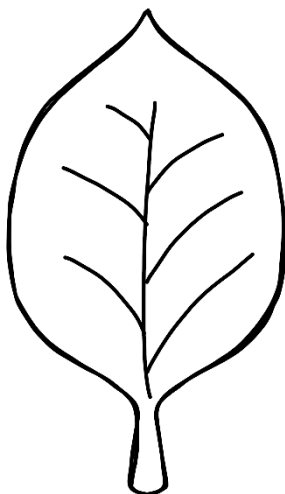
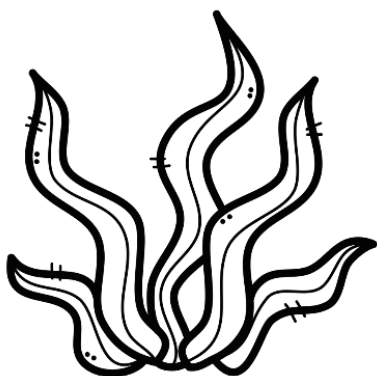
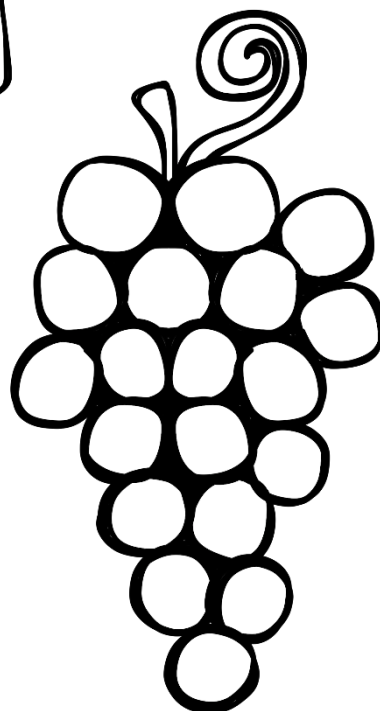
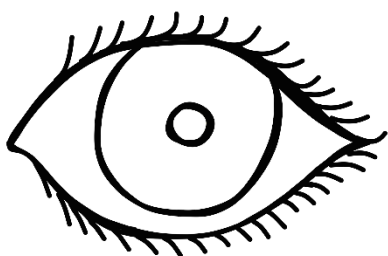
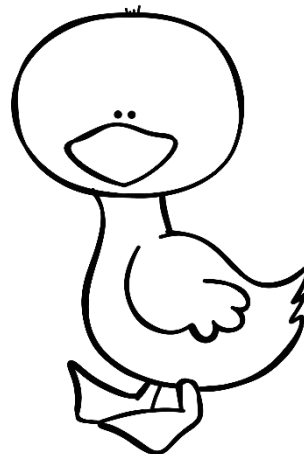
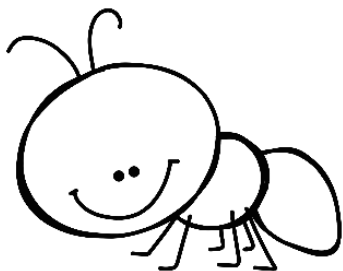
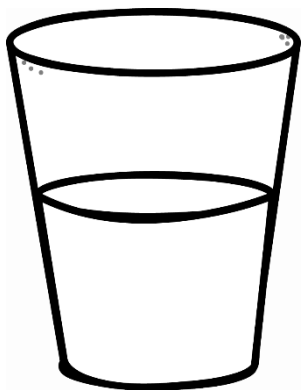

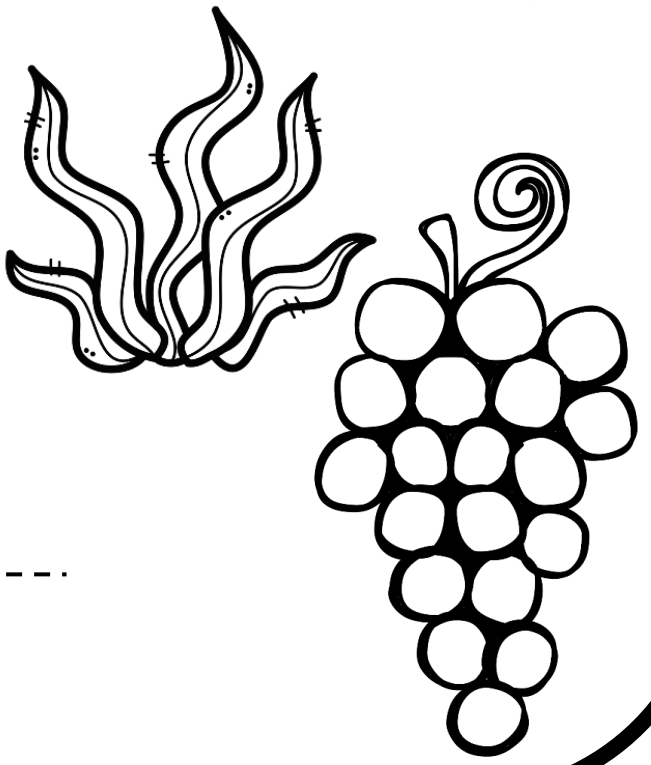
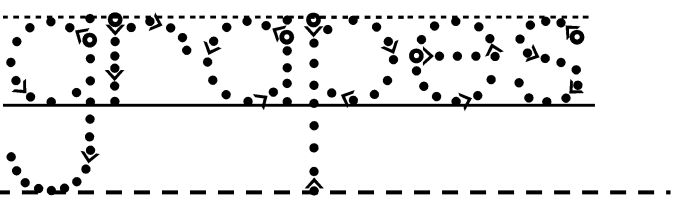
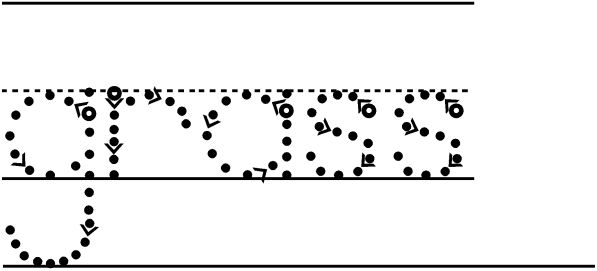
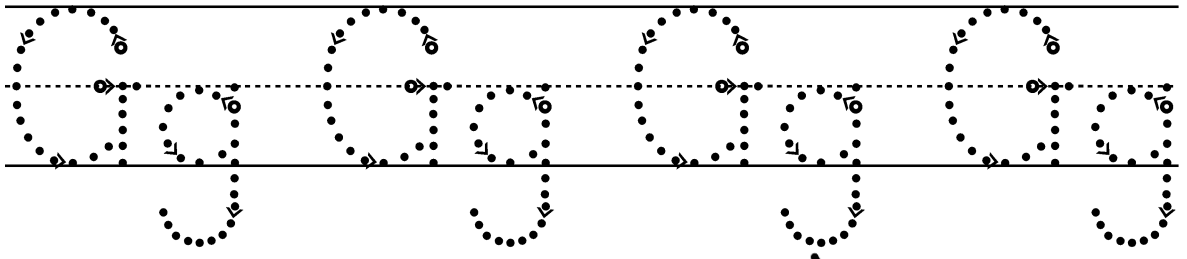
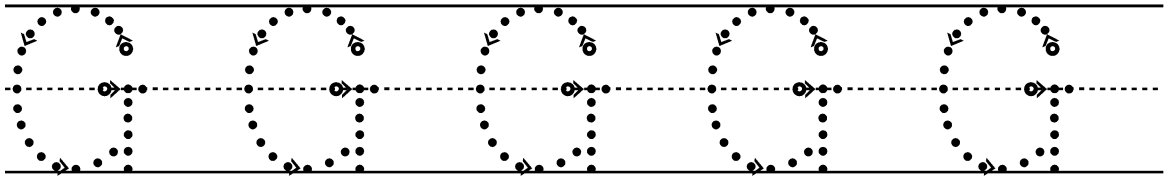
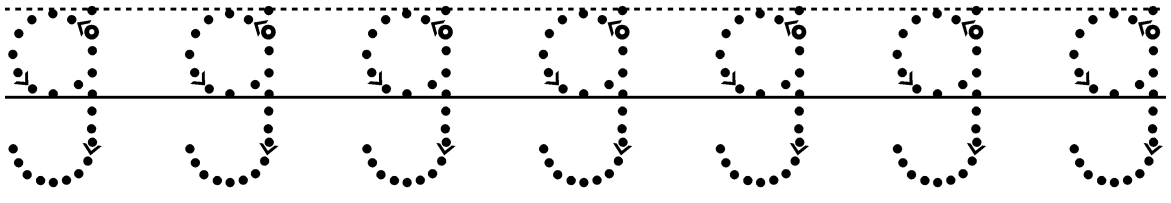
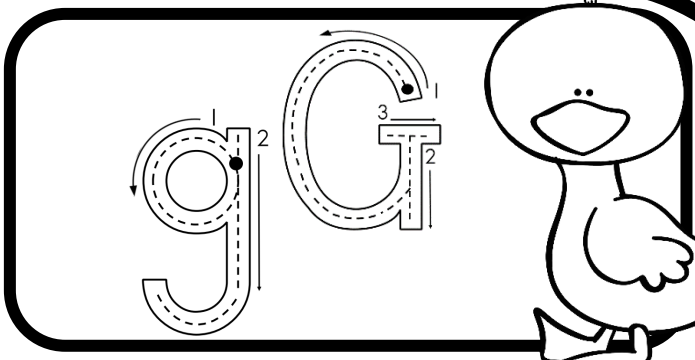

Colour the letter.



l - yellow

Read the words.

leg	lion	leaf	lamp
laugh	light	lip	lamb

Trace the letter.

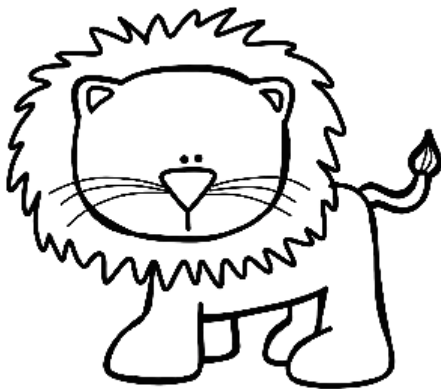

Circle all the "l" sounds.

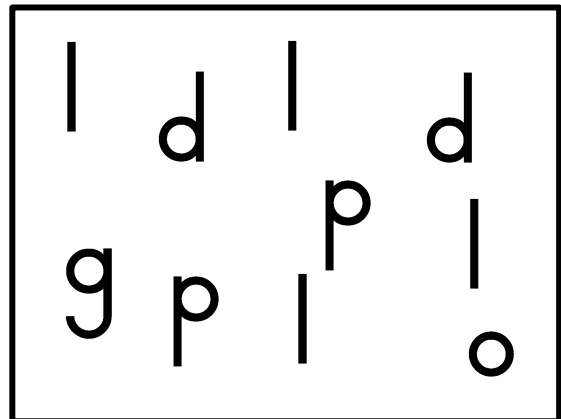

Practice writing the letter.

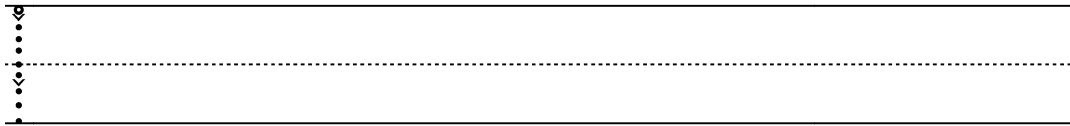

Complete the "l" sound in the words.

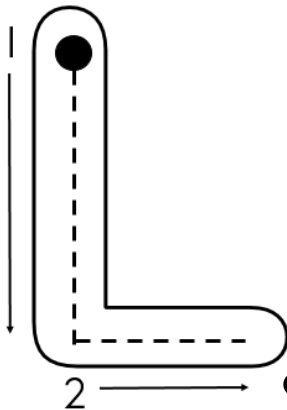

\_\_amp

\_\_eg

\_\_ion

\_\_eaf

Practice writing the capital letter.

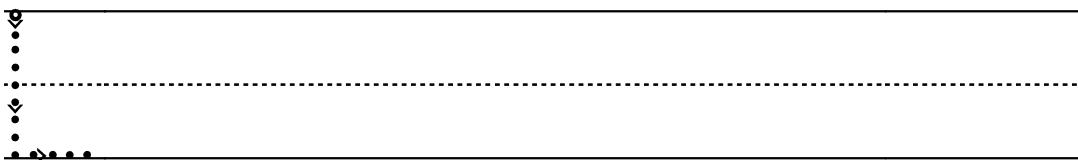



# "l" sound

Colour all the pictures that start with the "l" sound.

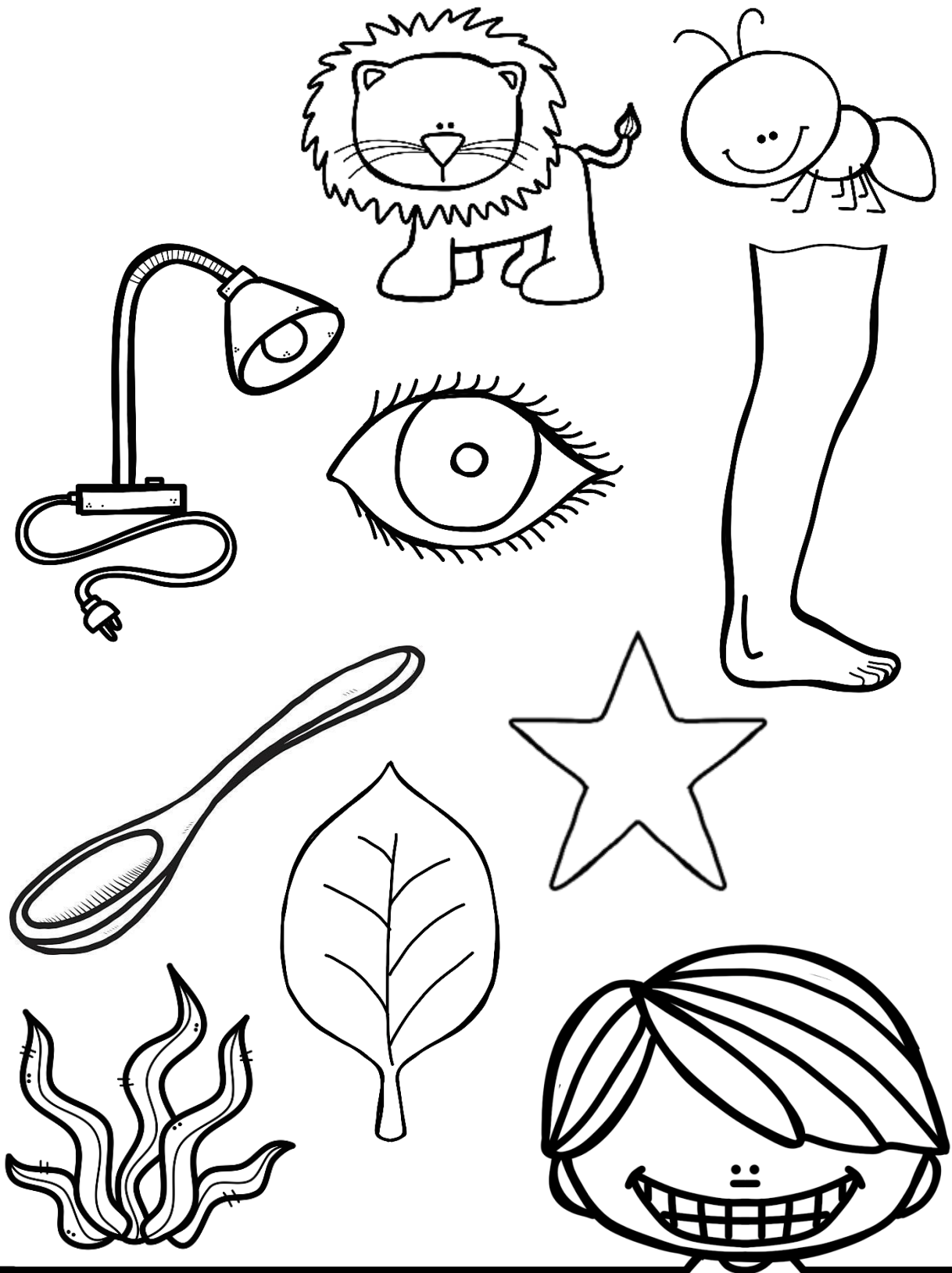

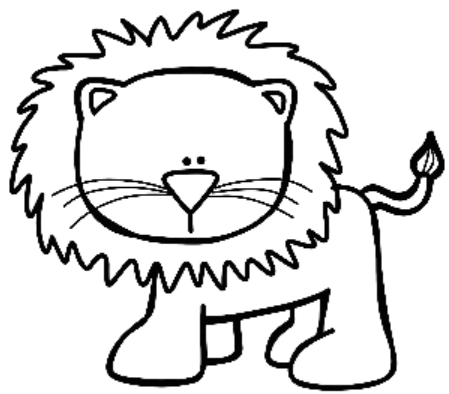
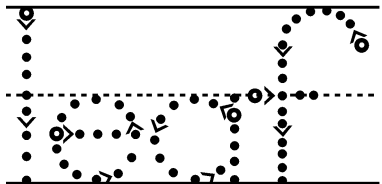
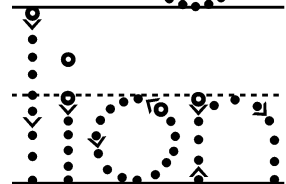
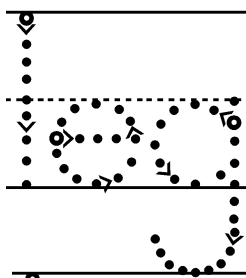
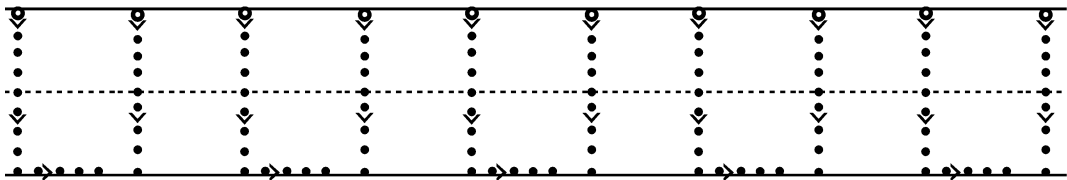
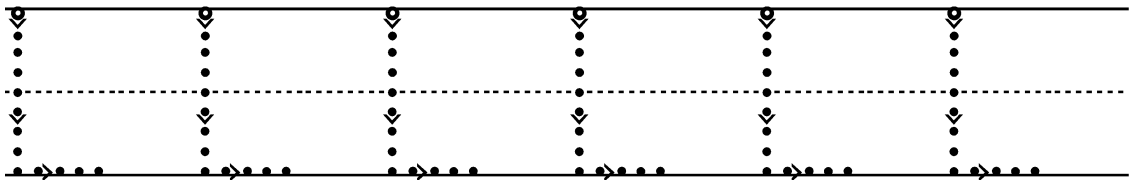
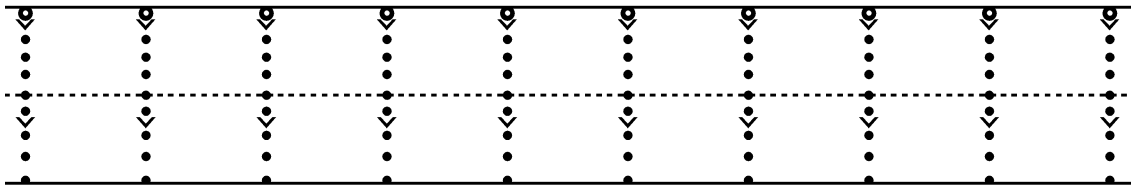
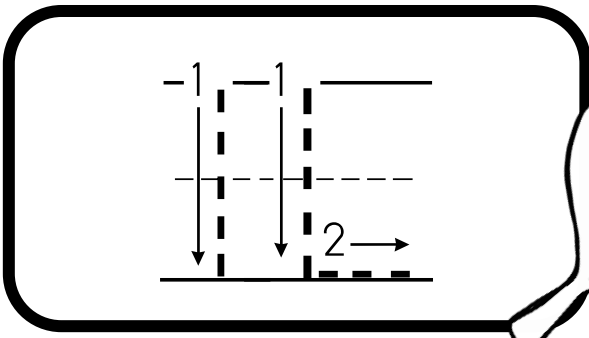

Colour the letter. l - pink

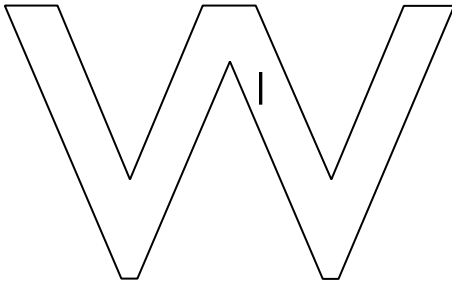

Read the words.

we	who	where	why
when	whale	worm	wool
water	wagon	watermelon	

Trace the letter.



Circle all the "w" sounds.

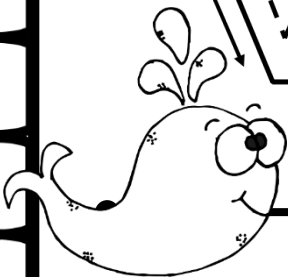
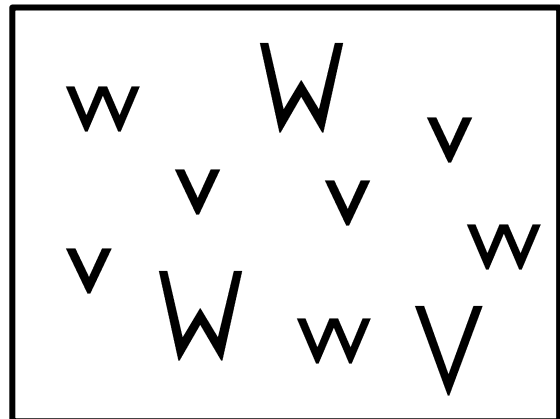

Practice writing the letter.

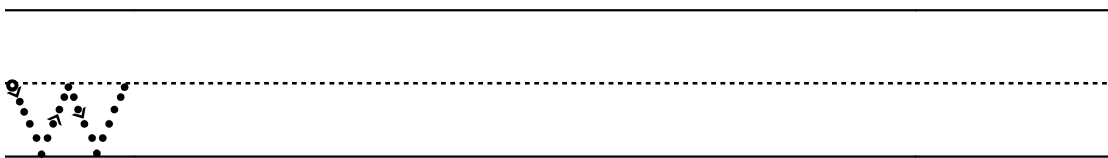

Complete the words by filling in the "w" sound.

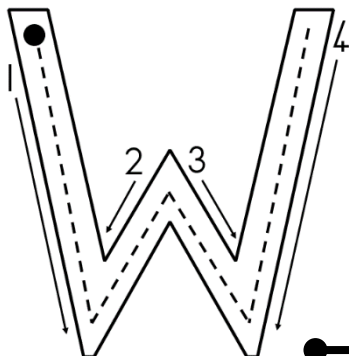

\_\_hale  
 \_\_ater  
 \_\_ool

\_\_orm  
 \_\_here  
 \_\_hy

Practice writing the capital letter.

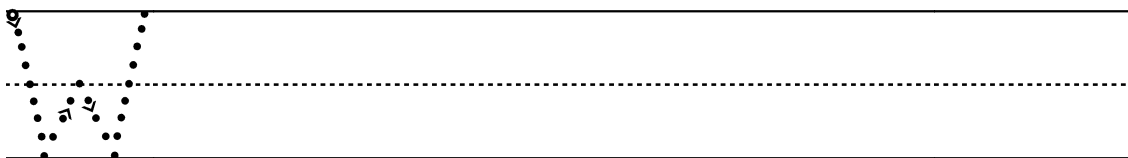

# "w" sound

Colour all the pictures that start with the "w" sound.

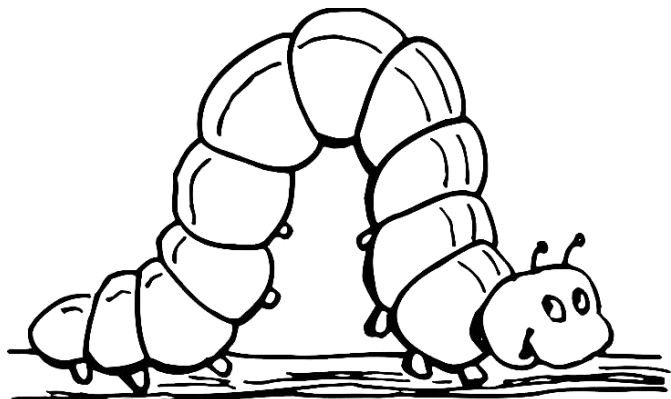
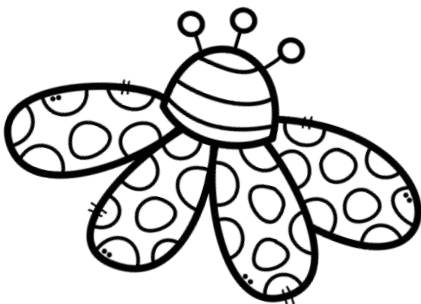
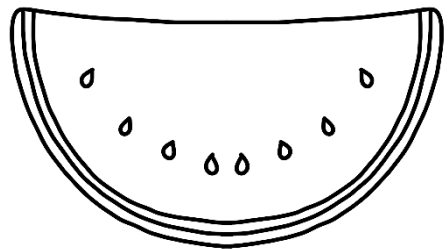
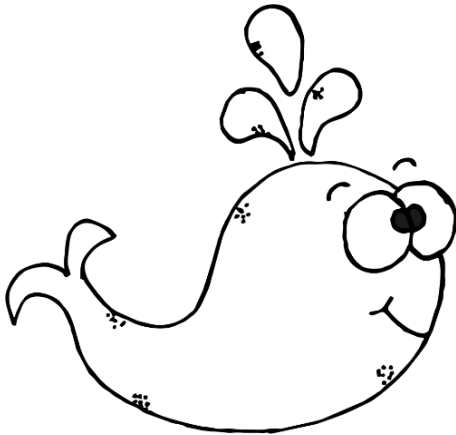
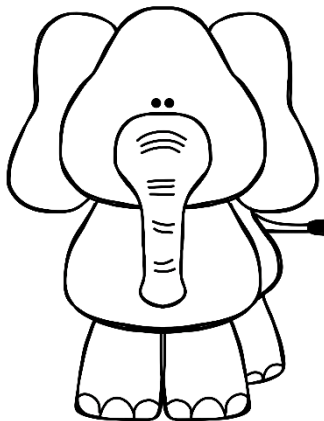
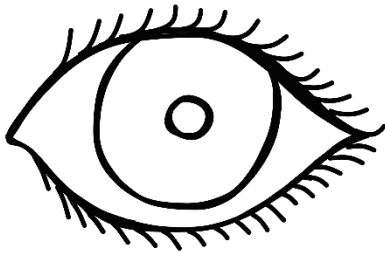
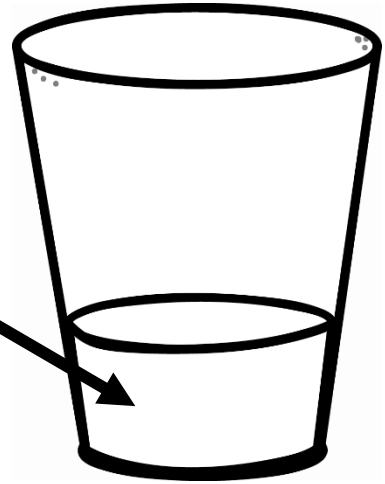
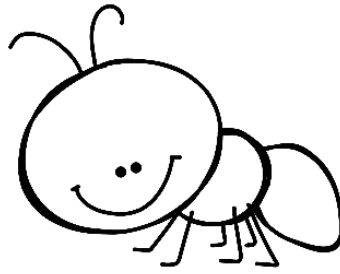
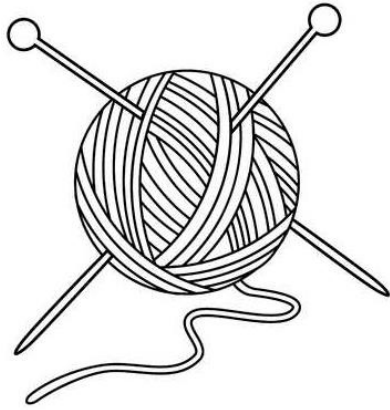

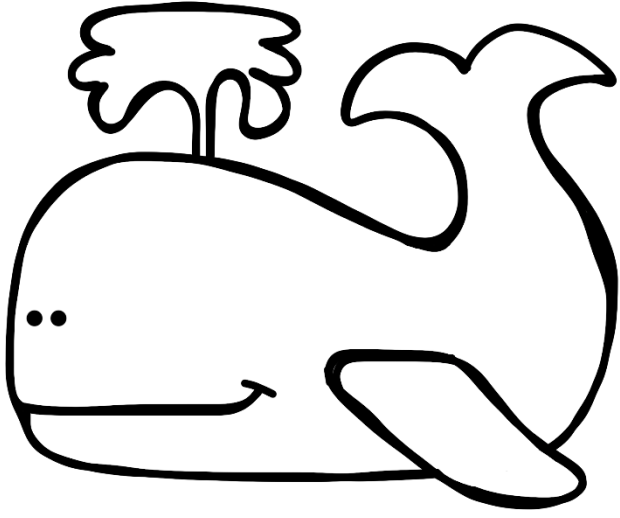
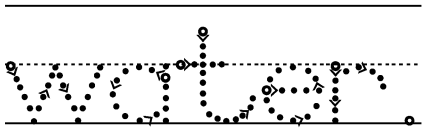
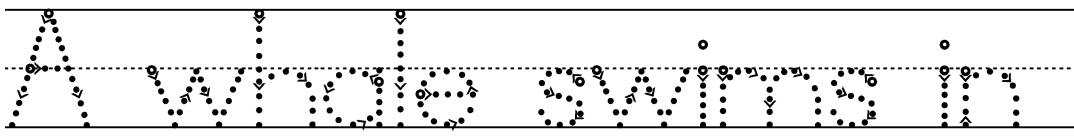
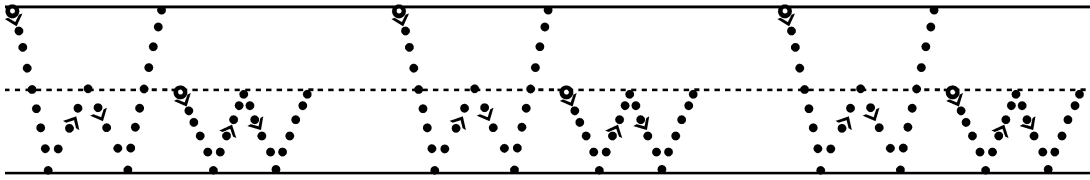
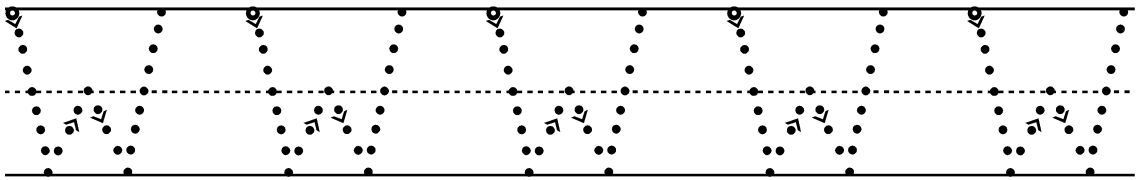
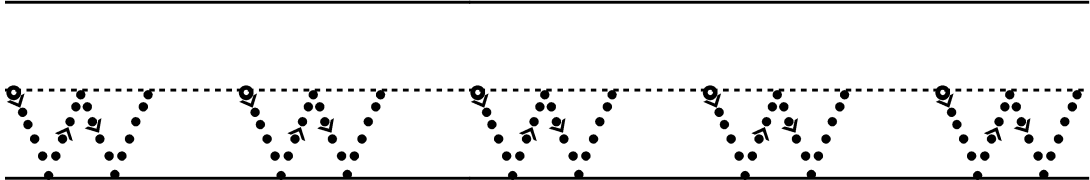
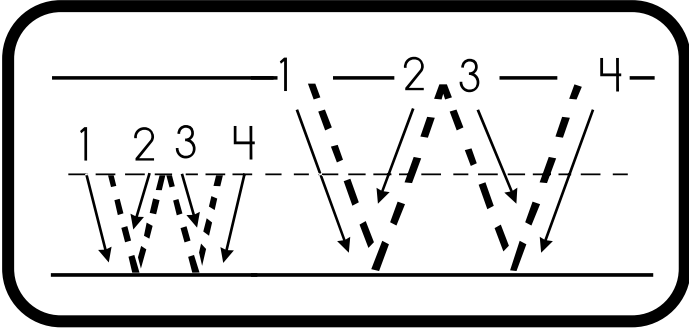

2  
○

Colour the letter.



1 - purple

2 - green

Read the words.

ink	igloo	ice
ice cream	insect	

Trace the letter.

2  
○

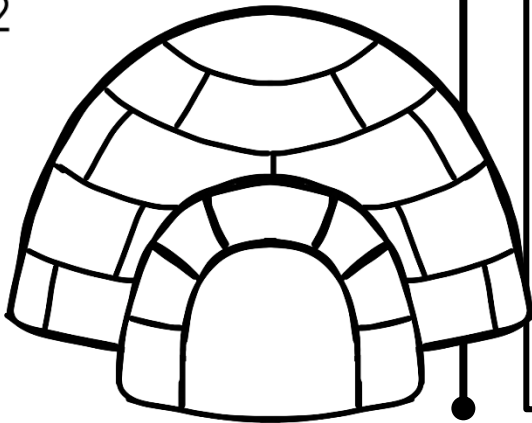

Circle all the "i" sounds.

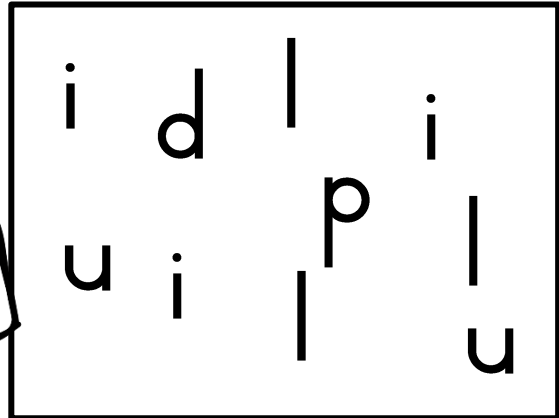

Practice writing the letter.

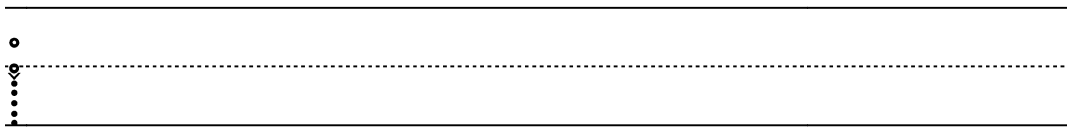

Complete the "i" sounds in the words.

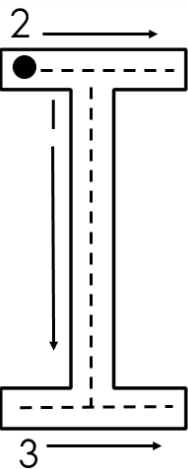

\_\_nsect

\_\_nk

\_\_gloo

\_\_ce

Practice writing the capital letter.

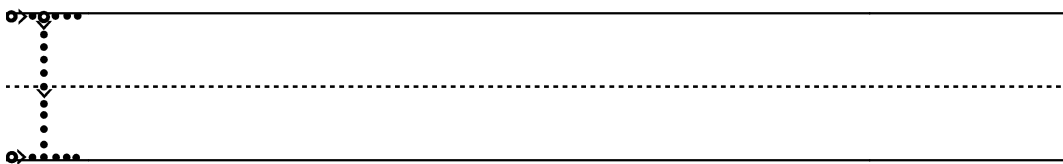

# "i" sound

Colour all the pictures that start with the "i" sound.

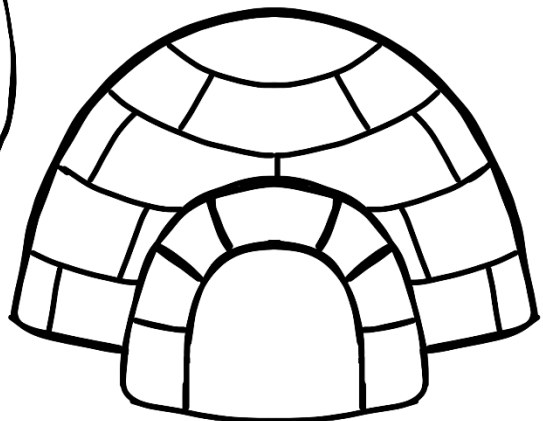
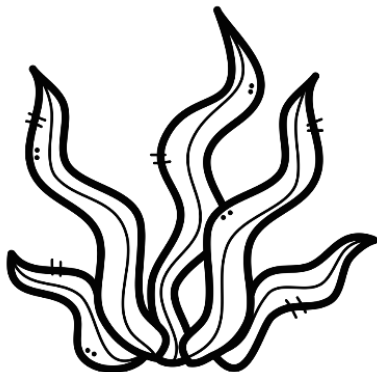
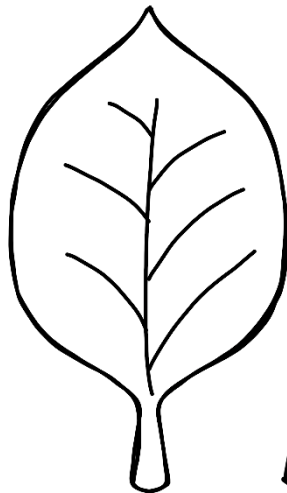
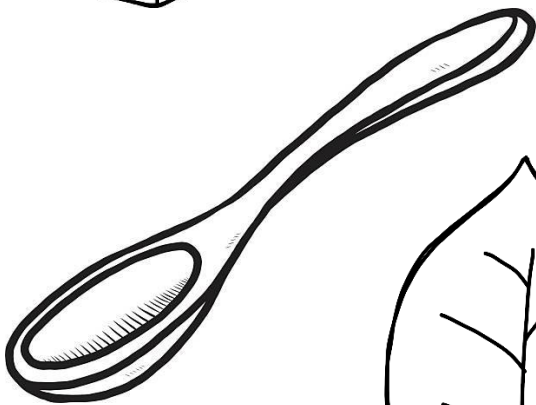
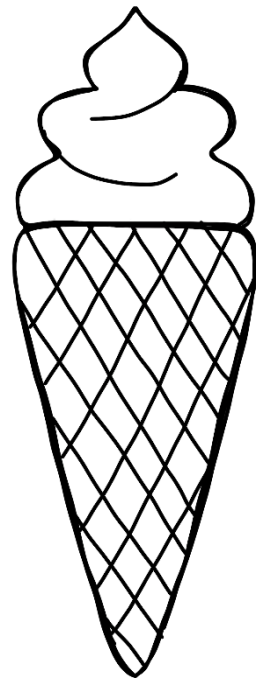
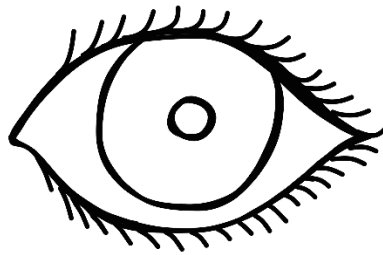
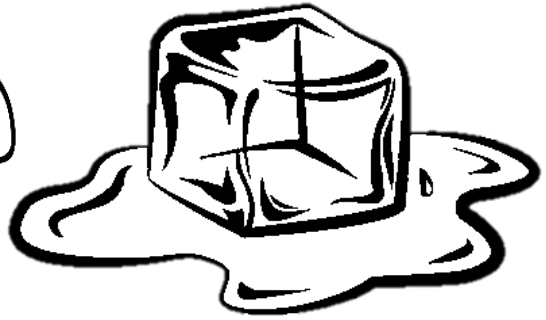
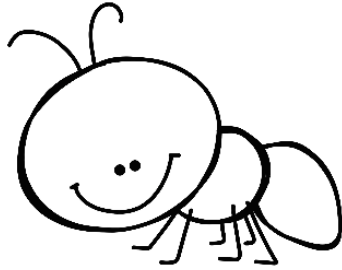

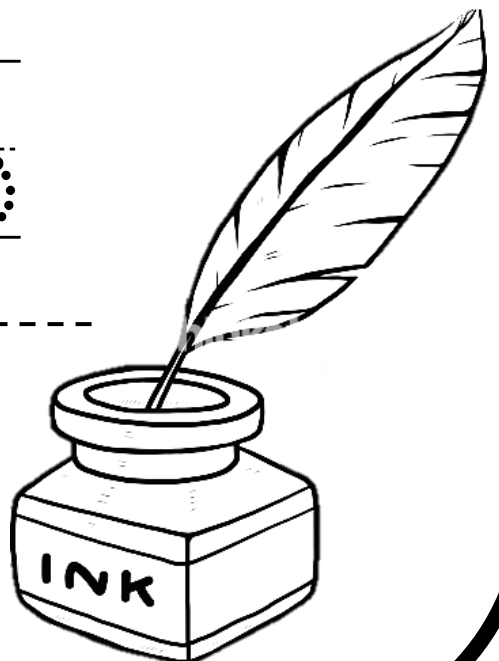
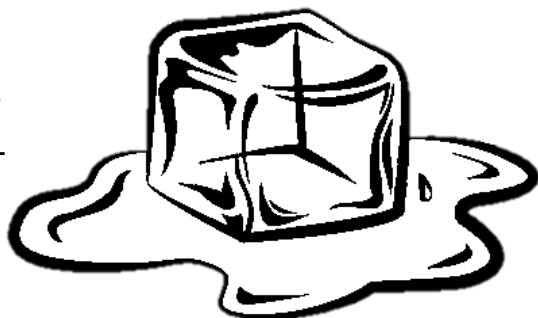
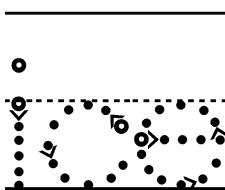
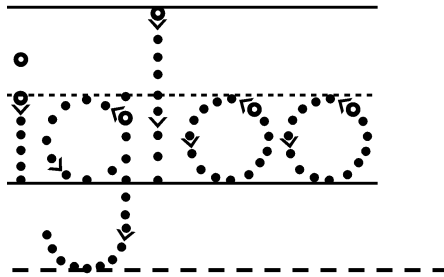
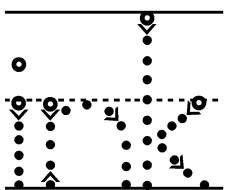
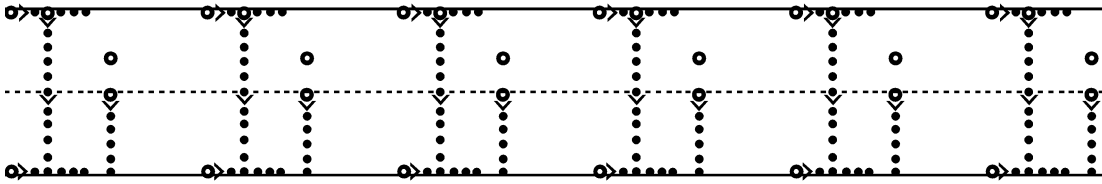
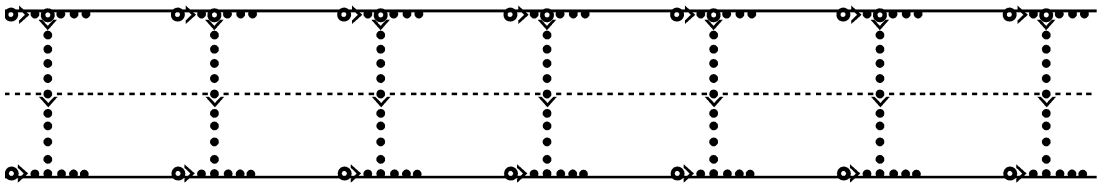
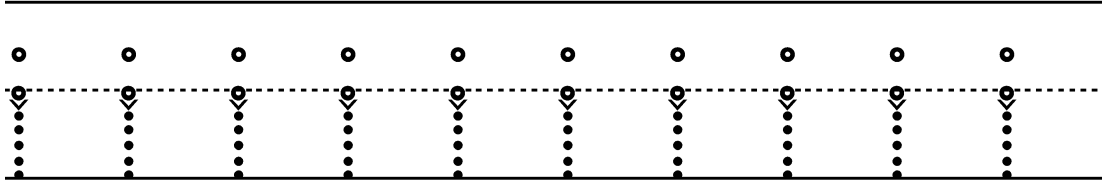
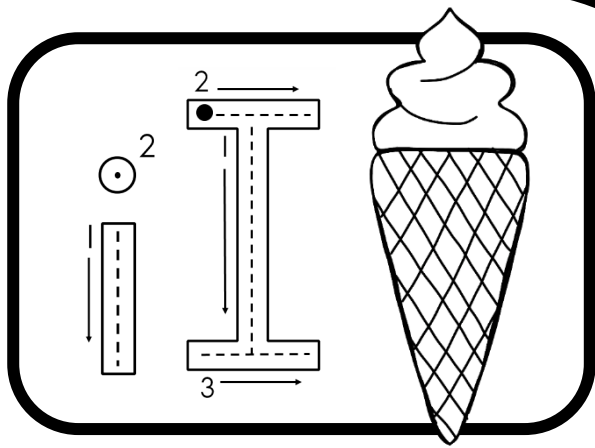



Colour the letter.

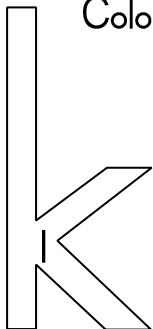

1 - orange

Read the words.

key

kite

kangaroo

Trace the letter.

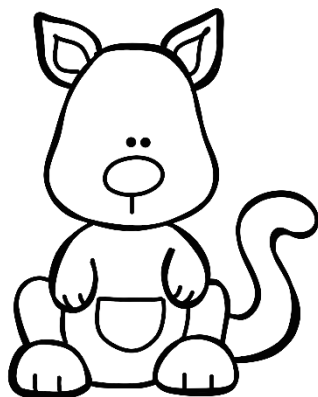
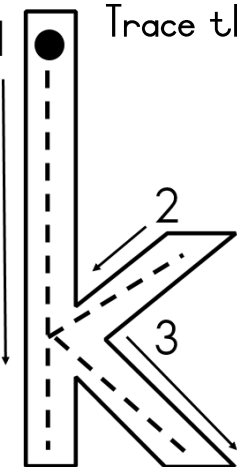

Circle all the "k" sounds.

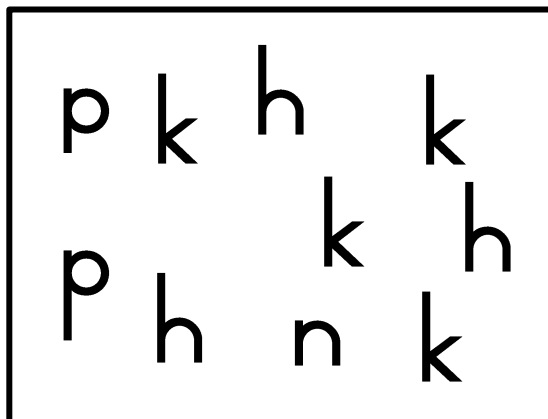

Practice writing the letter.

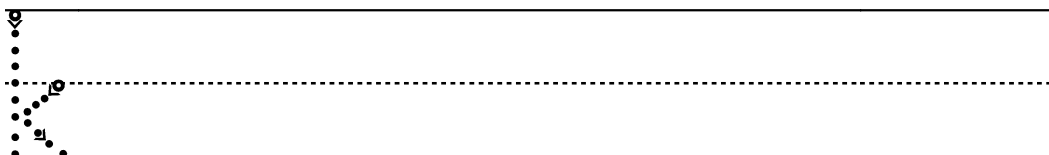

Trace the words.

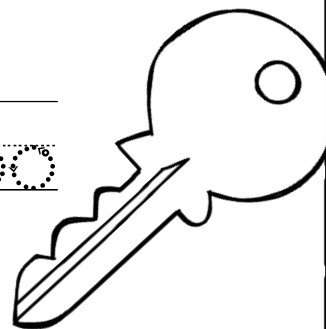
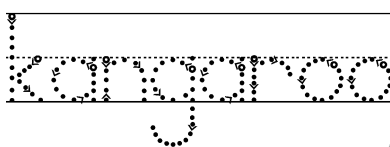
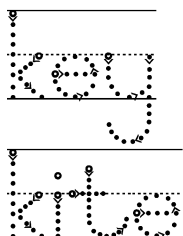
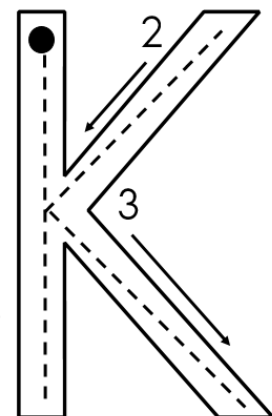

Practice writing the capital letter.

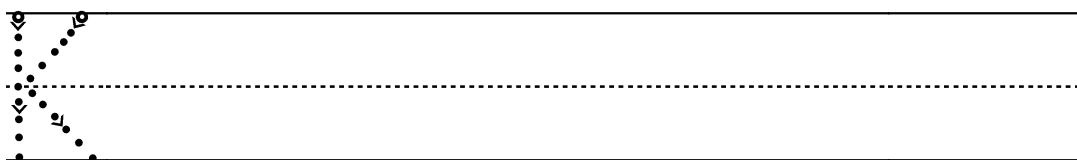

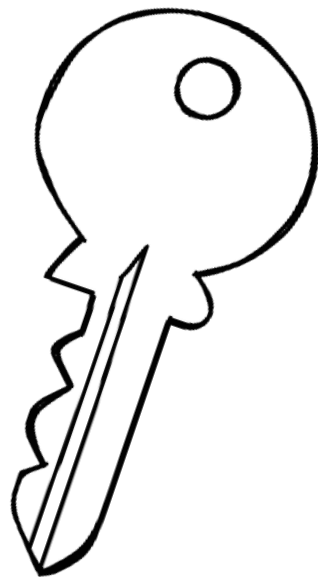
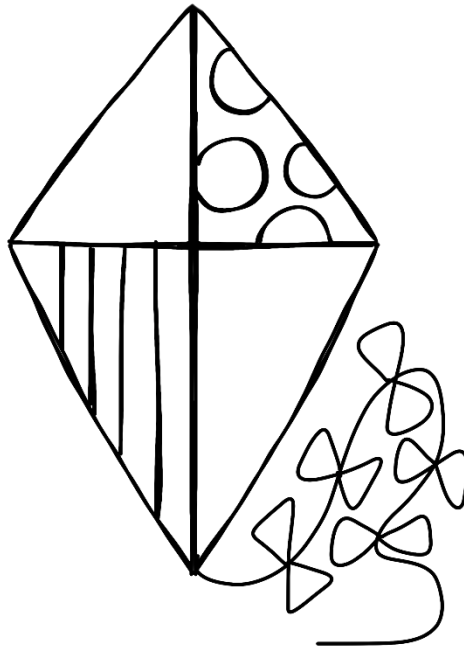
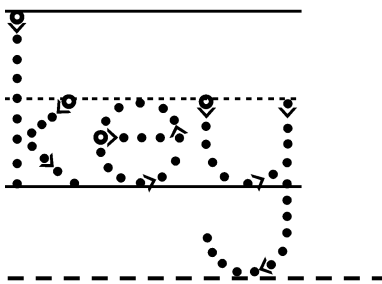
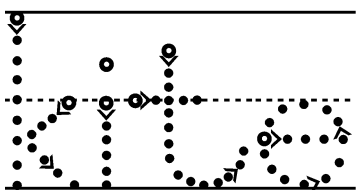
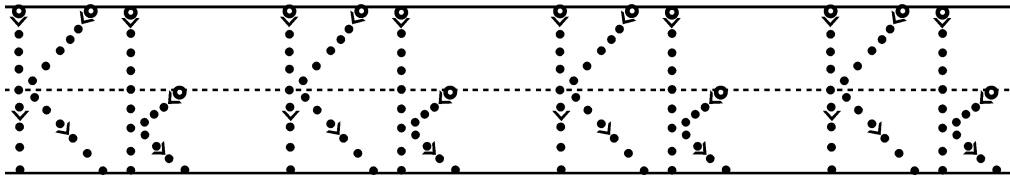
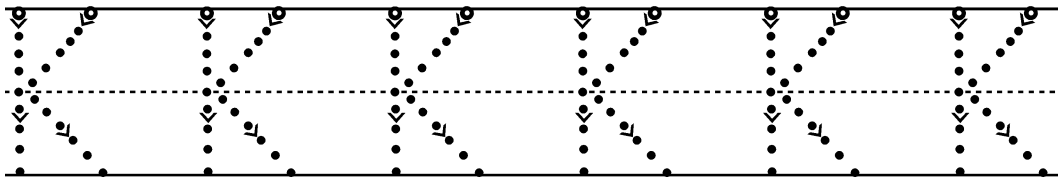
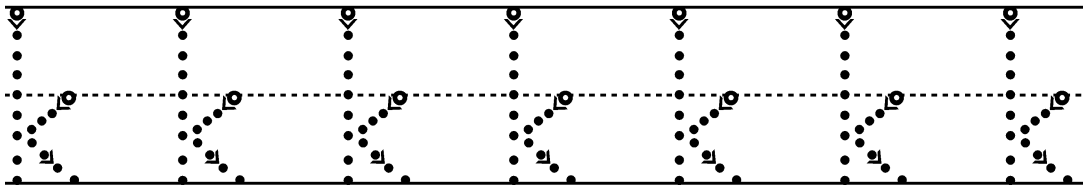
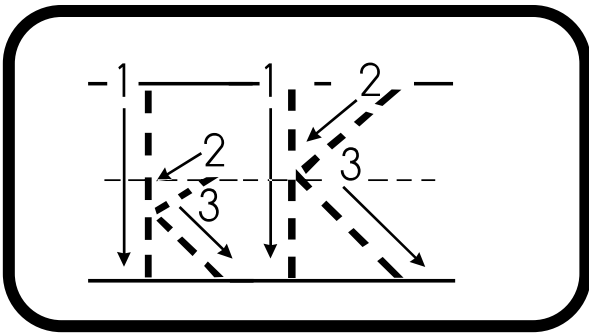

Colour the letter.

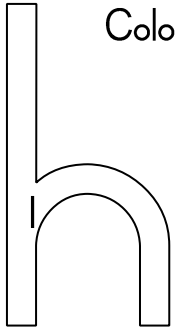

l - grey

Read the words.

he	her	him	heart
house	hat	horse	hop
help	hair	hand	hut

Trace the letter.

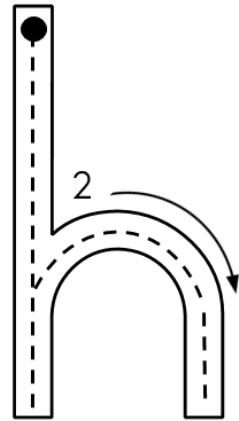

Circle all the "h" sounds.

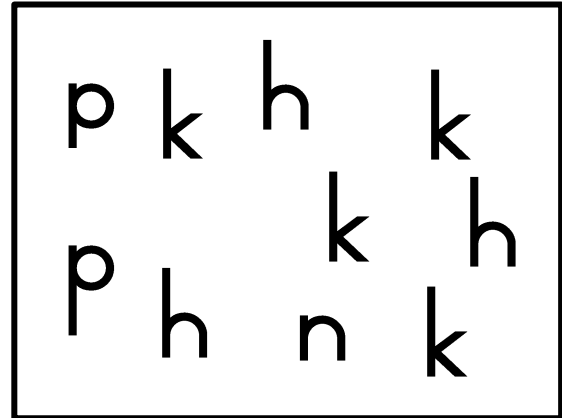

Practice writing the letter.

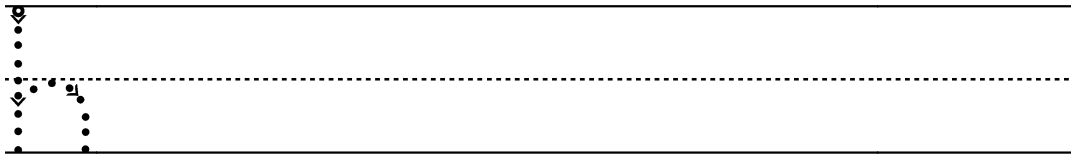

Trace the words.

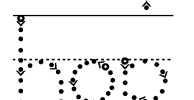
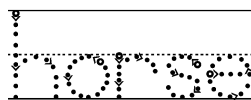
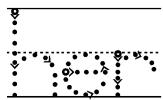
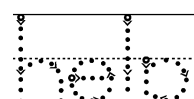
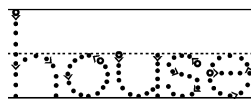
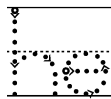
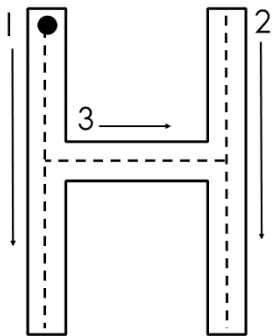

Practice writing the capital letter.

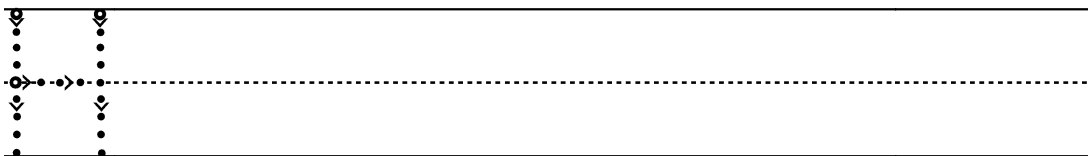

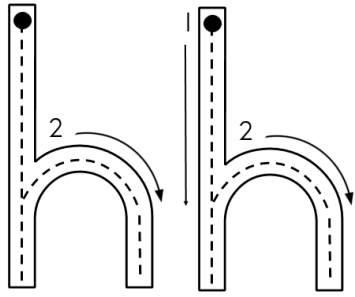

# "h" sound

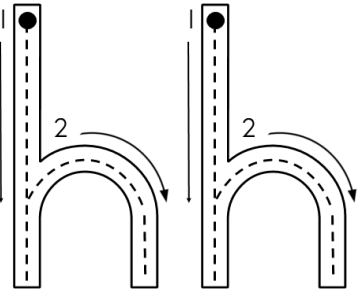

Complete the words.

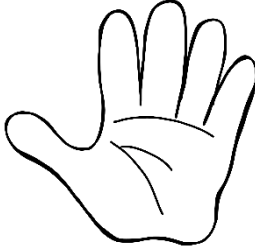

\_\_and

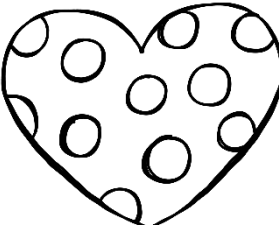

\_\_eart



\_\_ouse

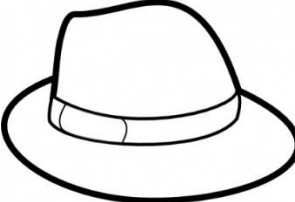

\_\_at

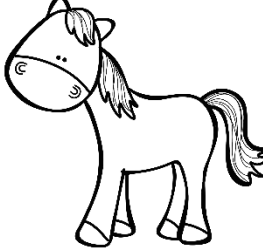

\_\_orse



\_\_ut



\_\_ug



\_\_elp



\_\_it

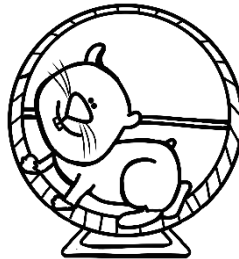

\_\_amster

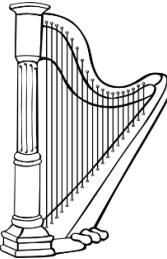

\_\_arp

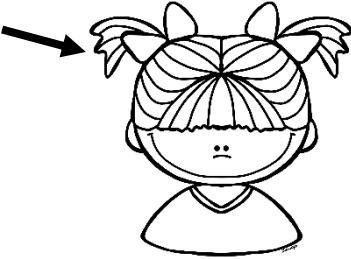

\_\_air

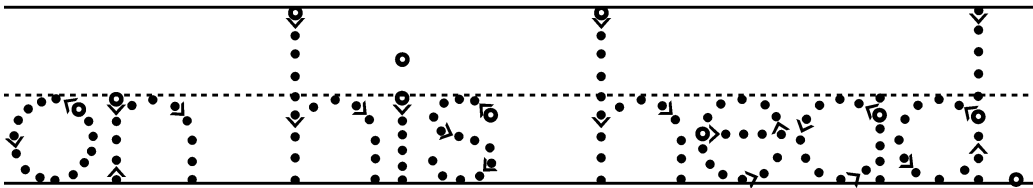
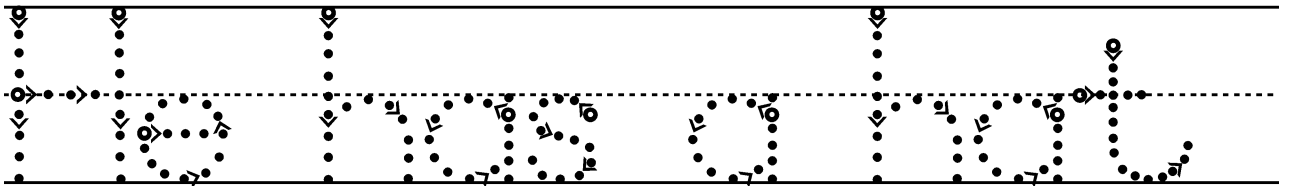
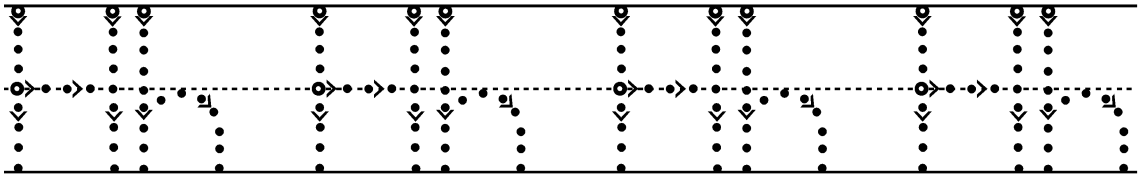
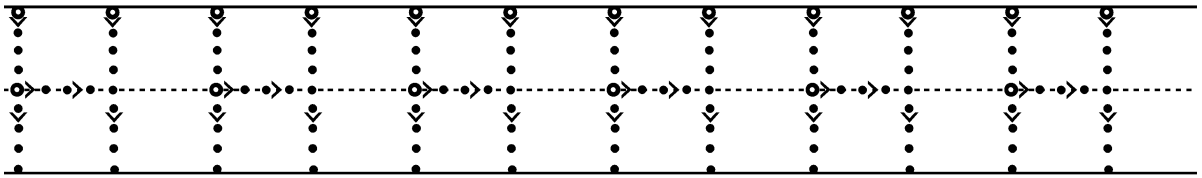
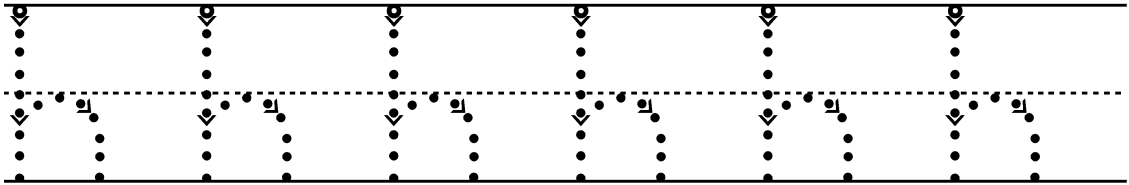
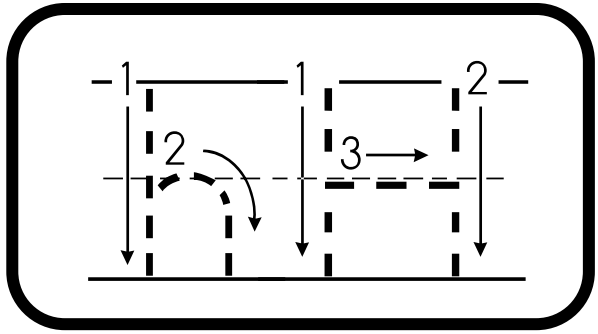
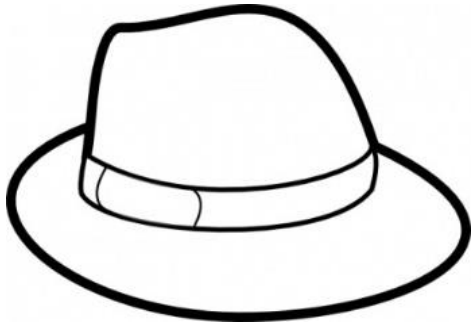

Colour the letter.

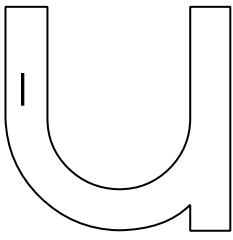

1 - yellow

Read the words.

up	under	upset
umbrella	unicorn	underwear
us	urn	ugly

Trace the letter.

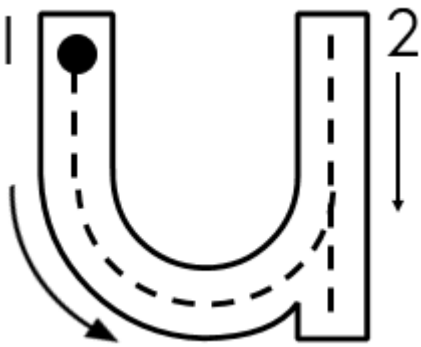

Colour all the "u" sounds.

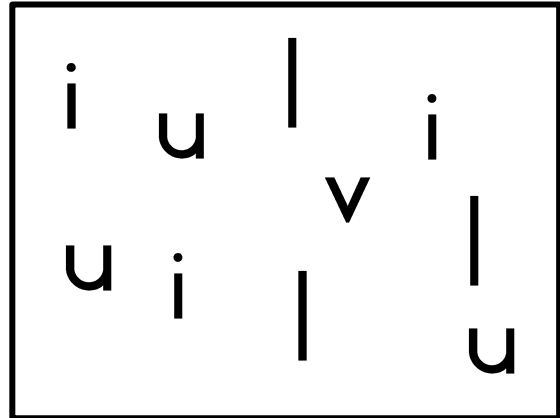

Practice writing the letter.

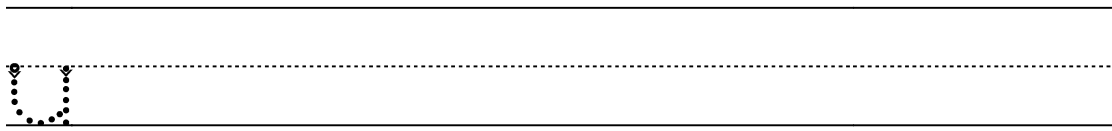

Trace the words.

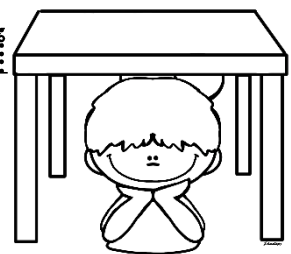
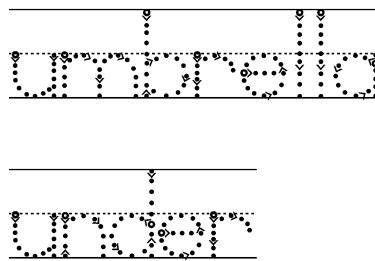
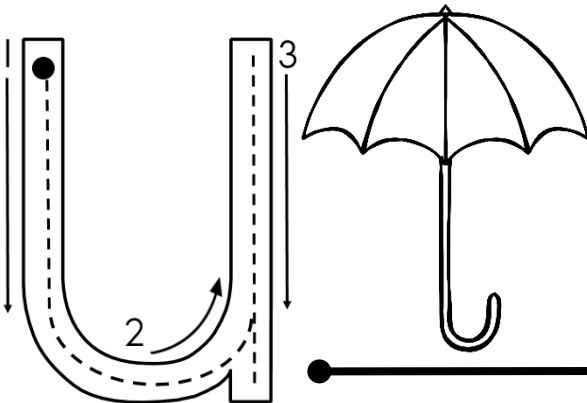

Practice writing the capital letter.

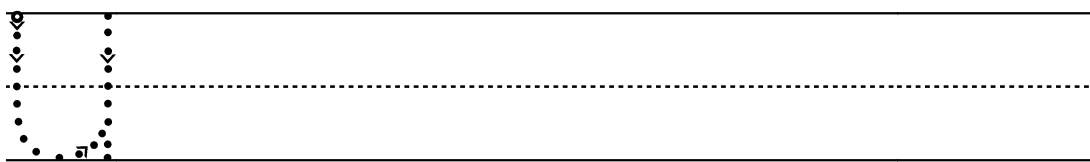

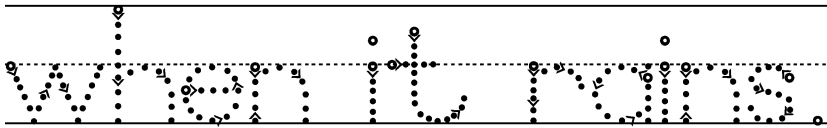
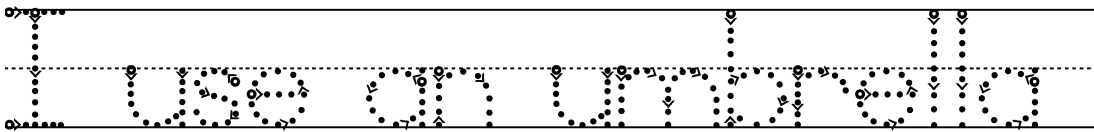
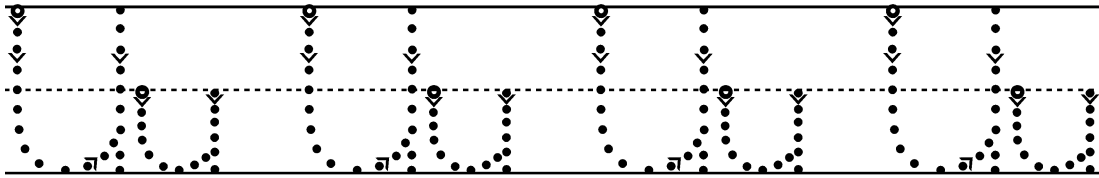
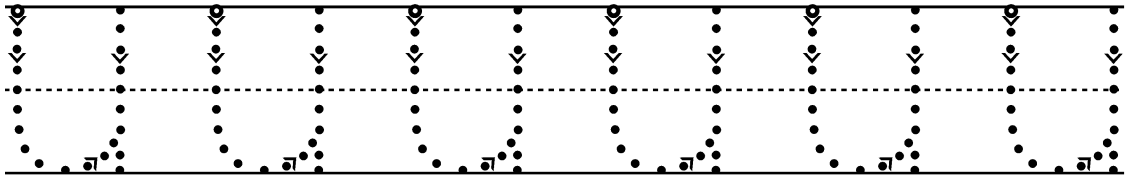
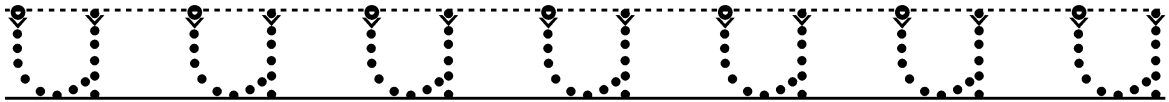
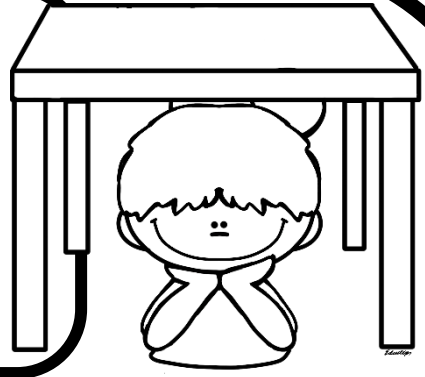
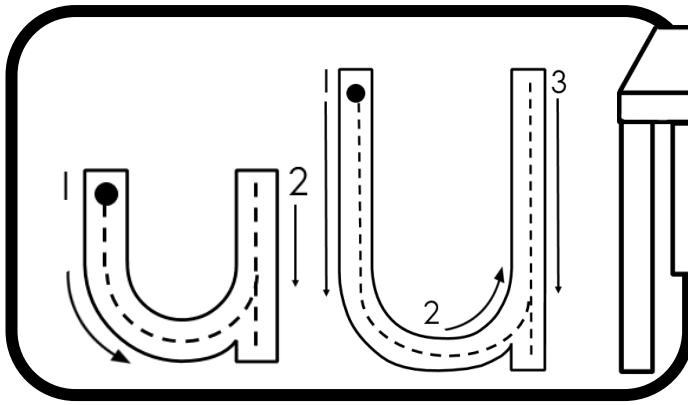

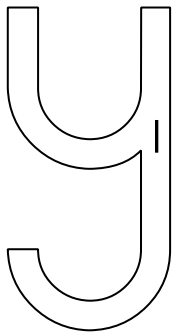

Colour the letter.

l - purple

Read the words.

you	yarn	yolk
yes	yellow	yoghurt

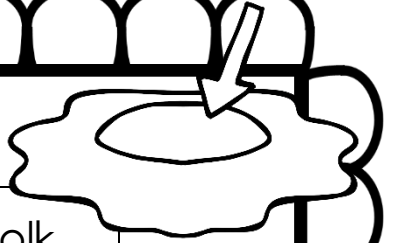

Trace the letter.

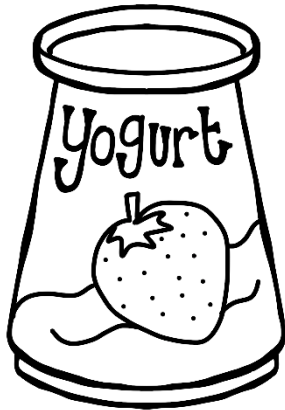
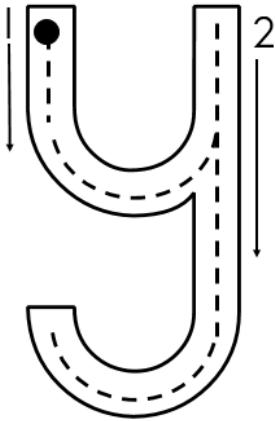

Circle all the "y" sounds.

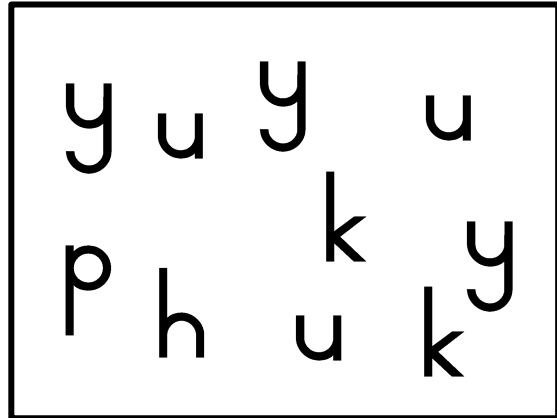

Practice writing the letter.

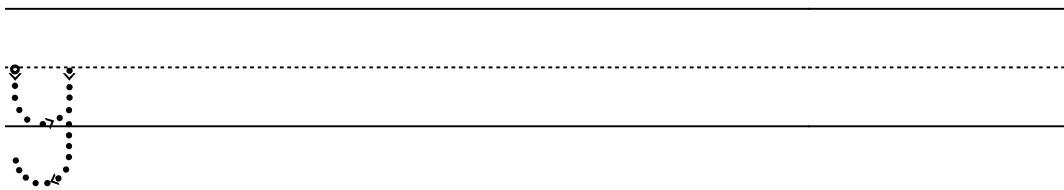

Trace the words.

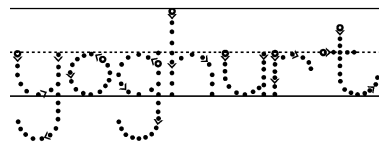
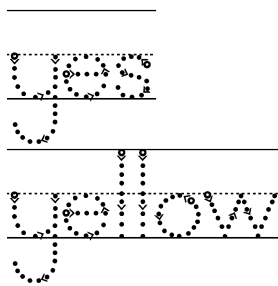
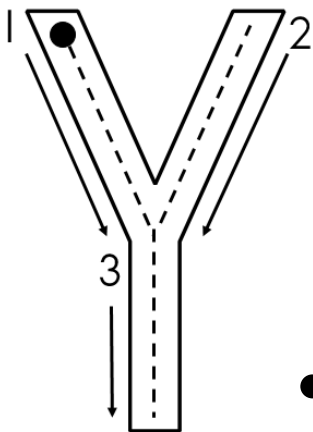

Practice writing the capital letter.

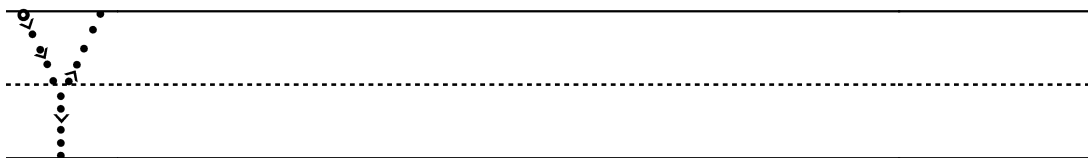



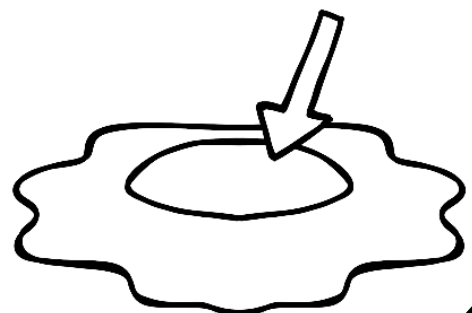
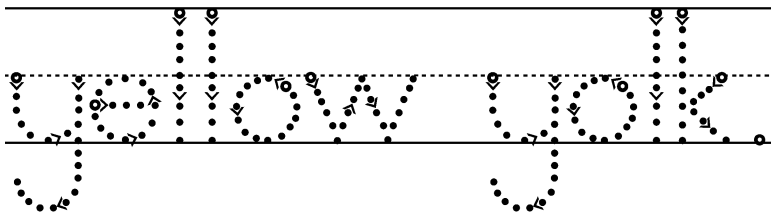
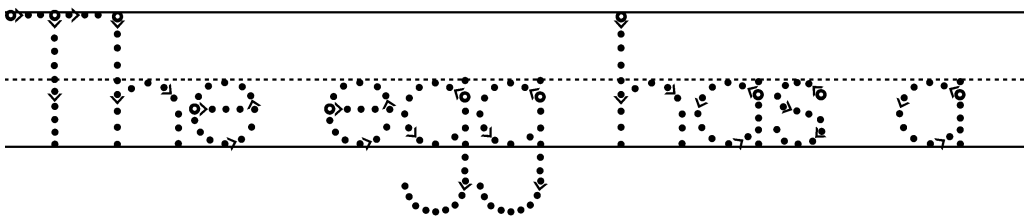
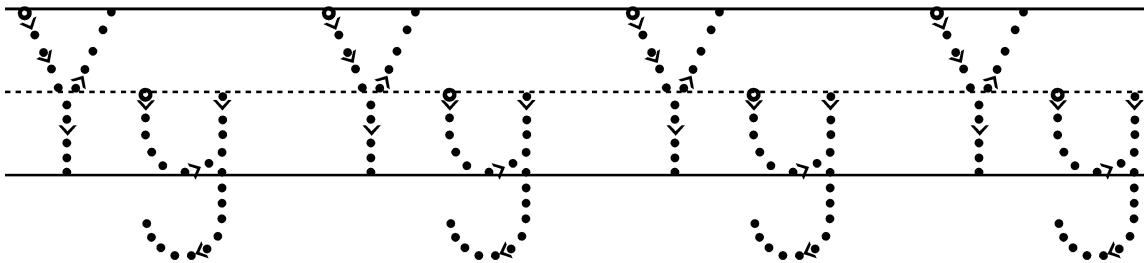
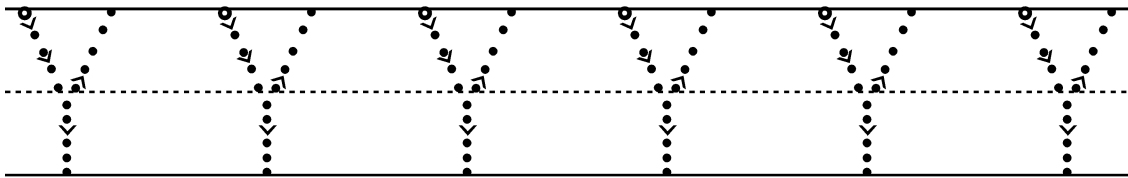
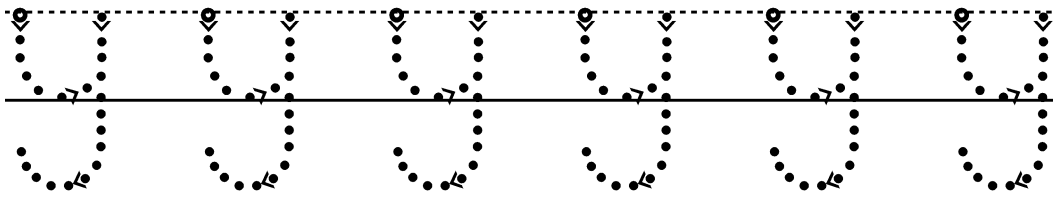
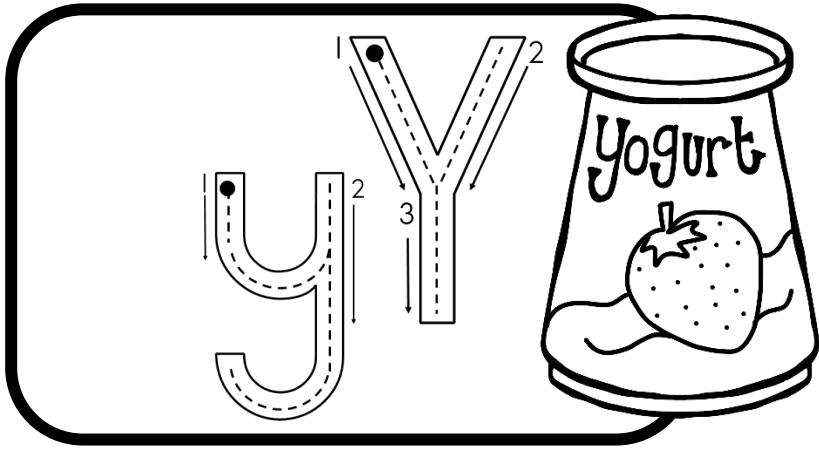

# Rhyming words.

Colour the pictures that rhyme with the first picture.

Rhyming words are words that sound the **same**.

