

Grade /
English
First Additional Language

Term 3

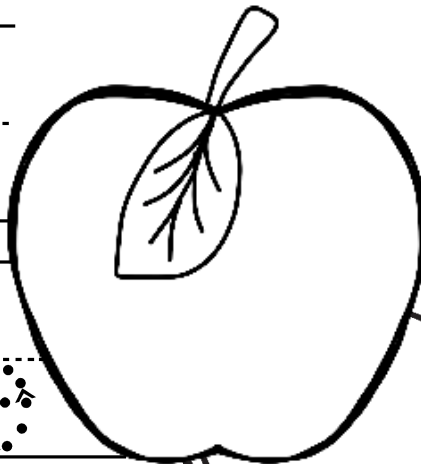
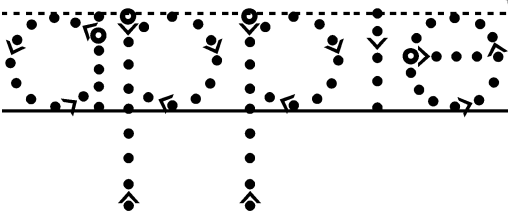
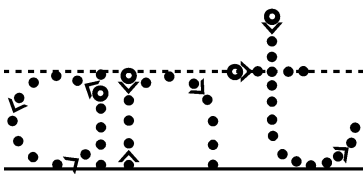
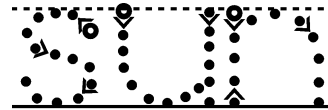
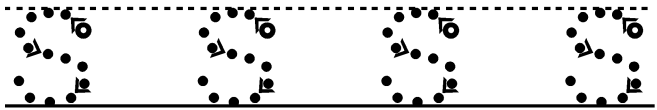
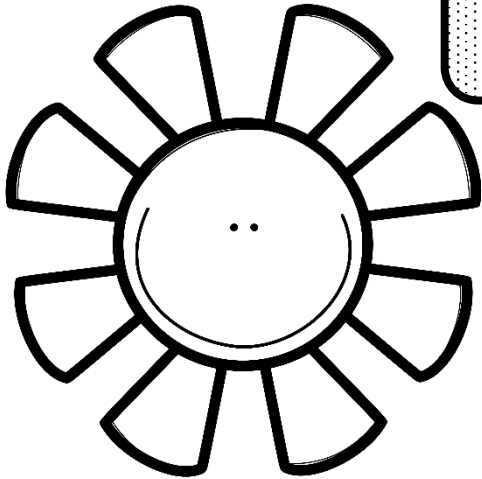

Name: _____

Colour the letter. | - red

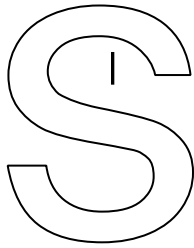

Read the words. Underline the s sound.

Sam	she	sat
sad	sit	sun
snake	sits	sock

Trace the letter.

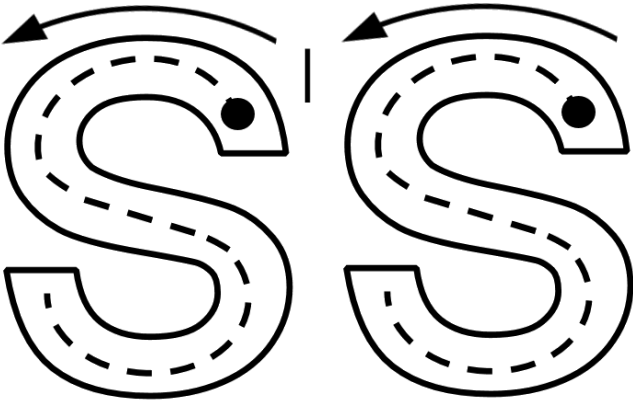

Colour the s sound.

s	v	r	c
c	s	s	t
w	r	g	s
k	o	s	c

Practice writing the letter.

Fill in the letter S in the spaces so that the words match the pictures.

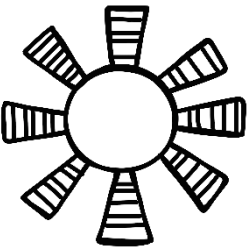
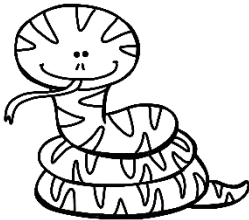
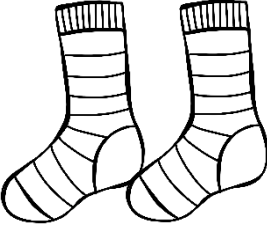
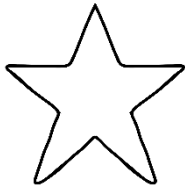
			
__un	__nake	__ock__	__tar

Colour the letter. 1 - blue

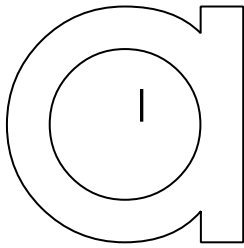

Read the words. Underline the a sound.

an	as	ant
Sam	apple	Ann

Trace the letter.

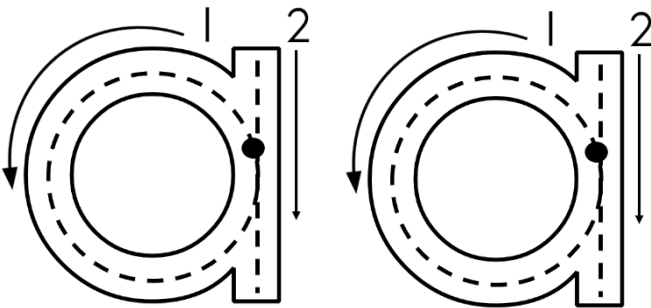

Colour the a sound.

s	a	a	c
c	s	s	t
e	o	a	s
a	o	s	c

Practice writing the letter.

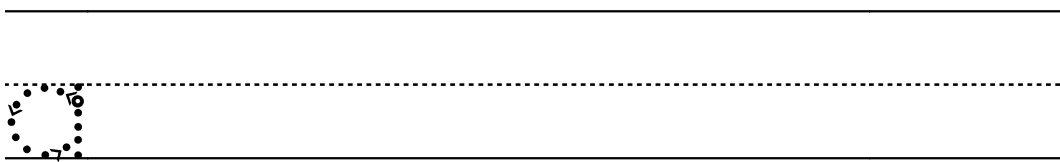

Fill in the letter a in the spaces so that the words match the pictures.

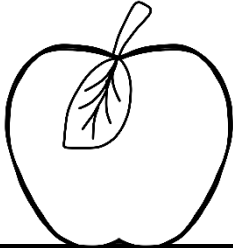
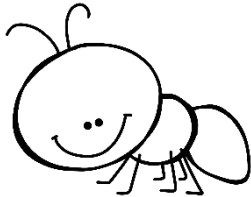
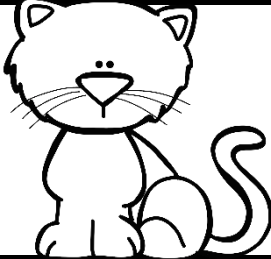
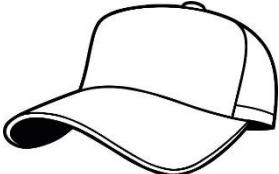
			
__pple	__nt	c__t	h__t

Rhyming words ending with

rat	cat	hat
fat	mat	bat
pat	sat	

at

The fat cat sat in the hat.

Build the words.

h + a + t →

c + a + t →

m + a + t →

b + a + t →

s + a + t →

r + a + t →

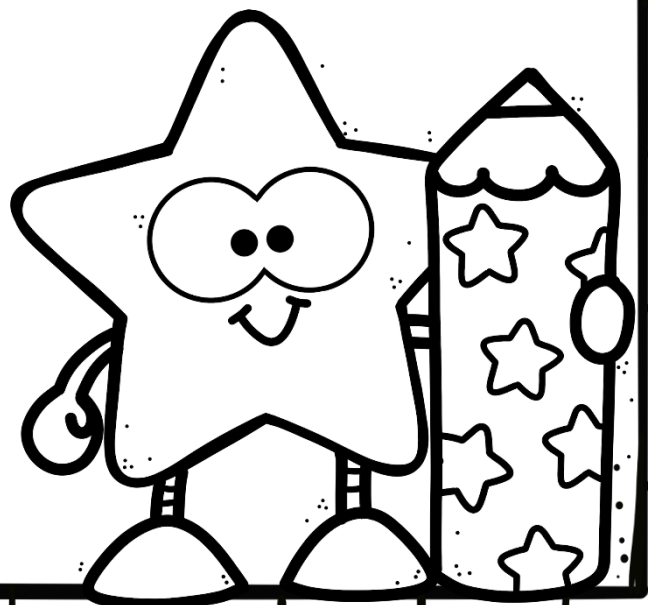

Colour the letter.

l - yellow

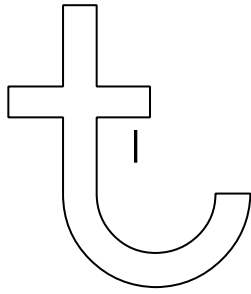

Read the words. Underline the t sound.

top	tip	tap
tub	tin	ten

Trace the letter.

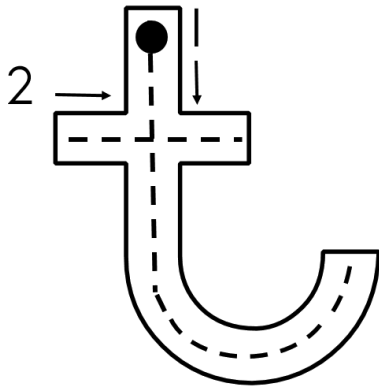

Colour the t sound.

s	d	t	c
t	s	d	t
e	o	t	s
a	t	s	c

Practice writing the letter.

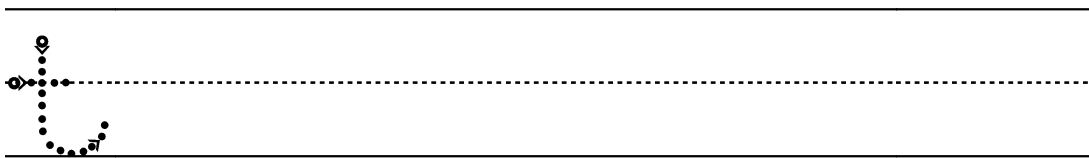

Fill in the letter t in the spaces so that the words match the pictures.

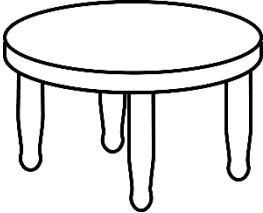
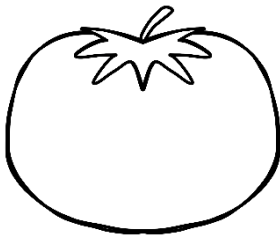
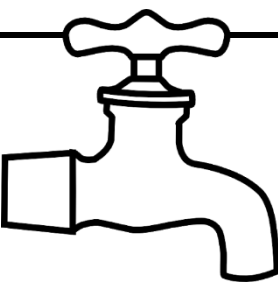
			
__ree	__able	__omato	__ap

Beginning sound

With which letter do the following words begin?

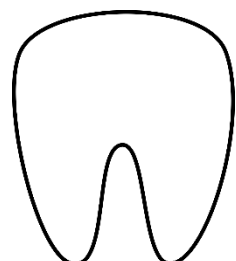
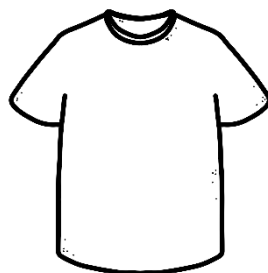
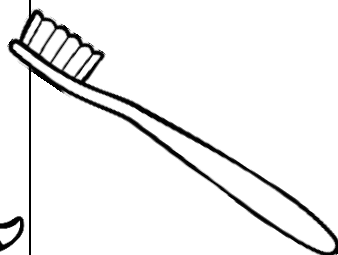
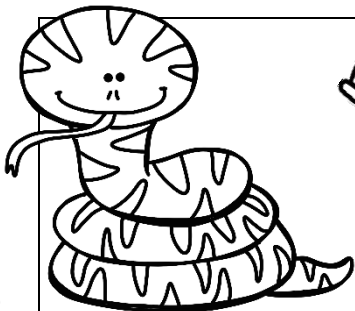
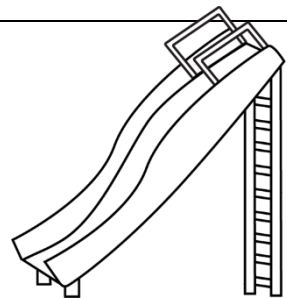
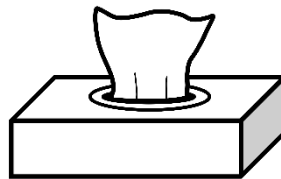
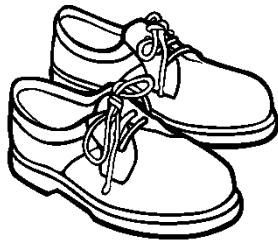
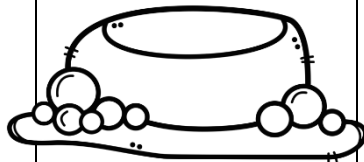
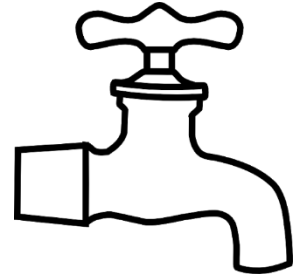
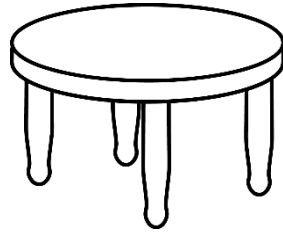
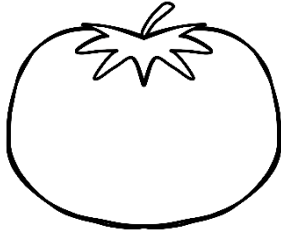
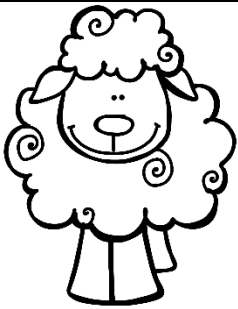

Colour the letter.

2 ○

1 - green

2 - blue

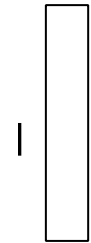

Read the words. Underline the i sound.

in	is	ink
it	tin	sit

Trace the letter.

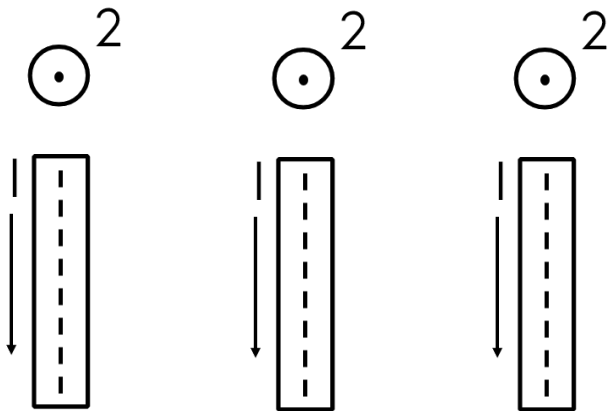

Colour the i sound.

s	i	v	u
i	u	i	w
e	o	v	i
i	v	u	c

Practice writing the letter.

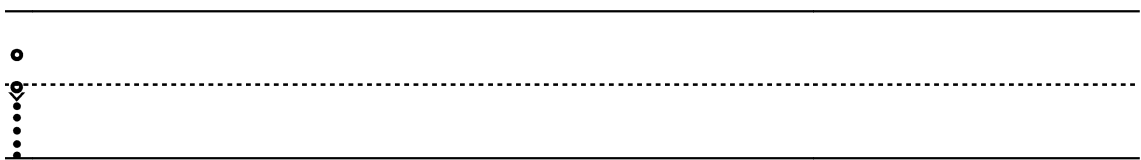

Fill in the letter i in the spaces so that the words match the pictures.

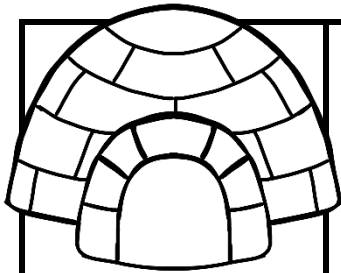

__gloo

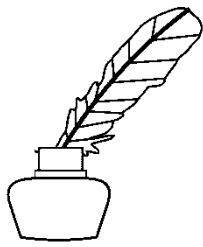

__nk



s_t

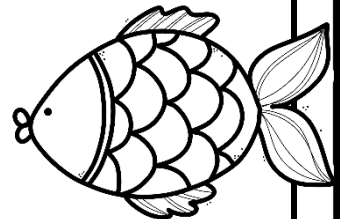

f__sh

Colour the letter.

l - purple

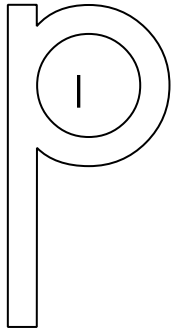

Read the words. Underline the p sound.

pig	pot	pat
pit	pan	pond
pink	pen	pea

Trace the letter.

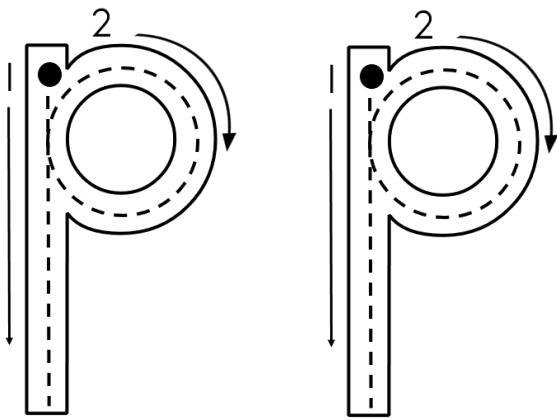

Colour the p sound.

p	i	v	p
i	d	i	d
p	o	p	i
i	v	u	d

Practice writing the letter.

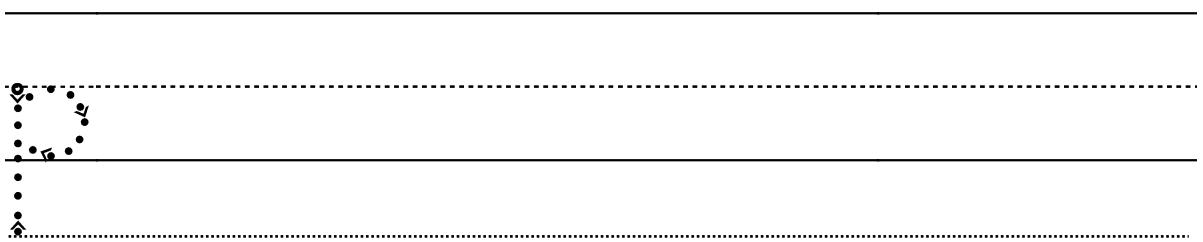

Fill in the letter p in the spaces so that the words match the pictures.

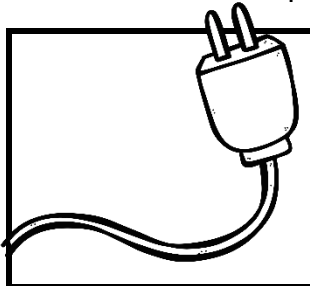
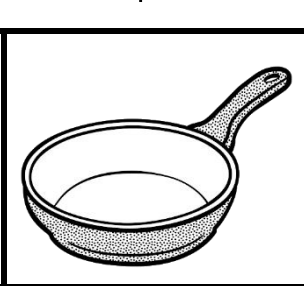
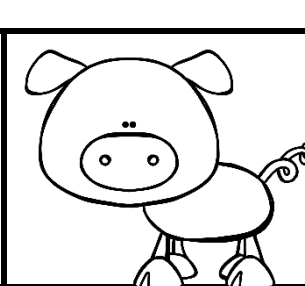
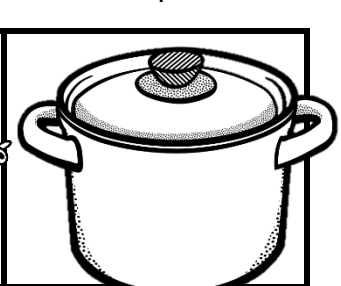
			
__lug	__an	__ig	__ot

Colour the letter.

1 - pink

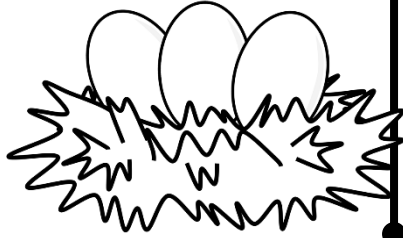
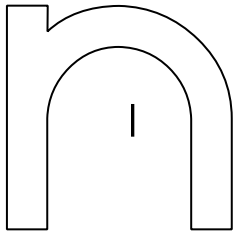

Read the words. Underline the n sound.

no	new	name
not	nest	net
nut	nose	neck

Trace the letter.

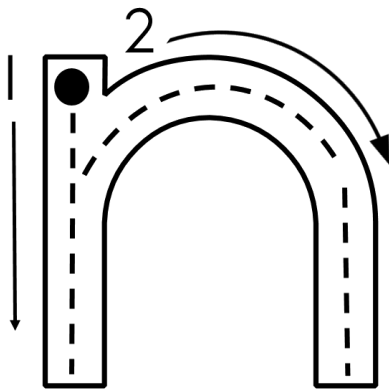

Colour the n sound.

p	i	m	n
n	d	n	d
p	o	p	n
o	n	m	d

Practice writing the letter.

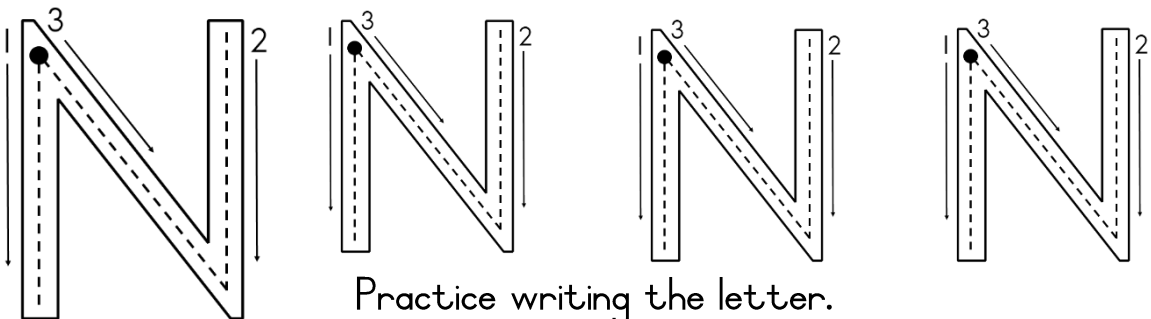
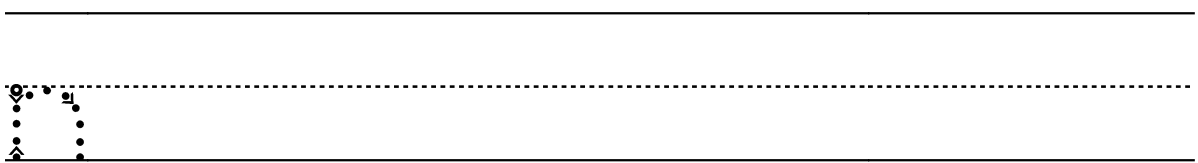

Practice writing the letter.

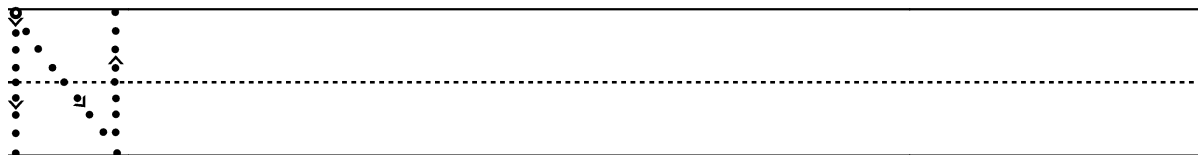

Fill in the letter **n** in the spaces so that the words match the pictures.

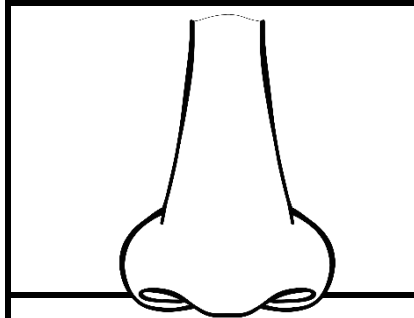

__ose

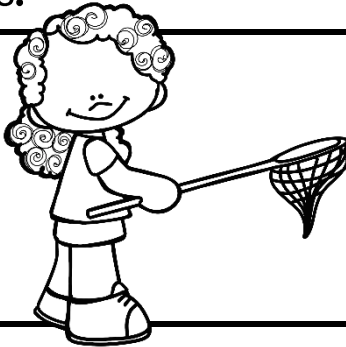

__et

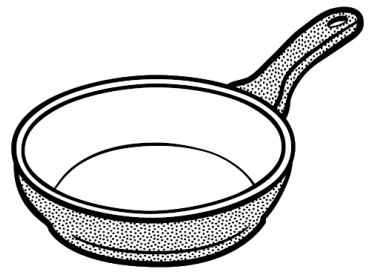

pa__

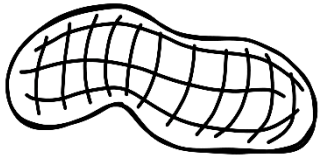

__ut

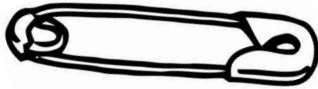

pi__

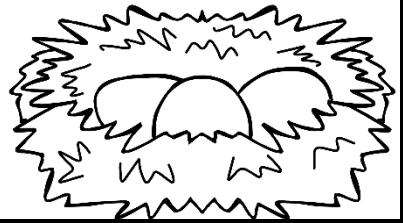

__est

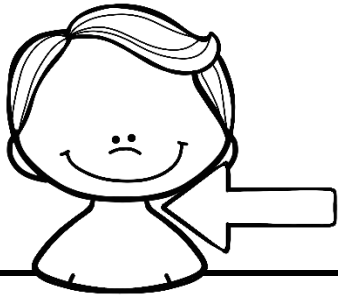

__eck

My ____ is Mary.



__ame

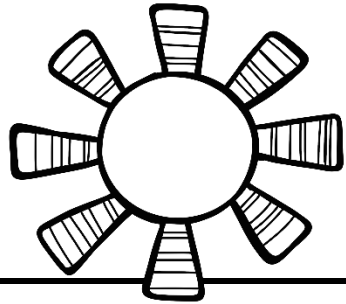

su__

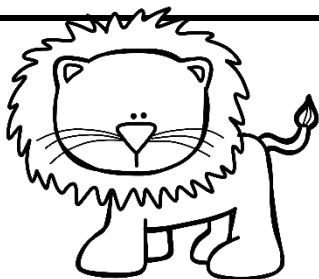

lio__

I

o__e

10

te__

Colour the letter.

l - grey

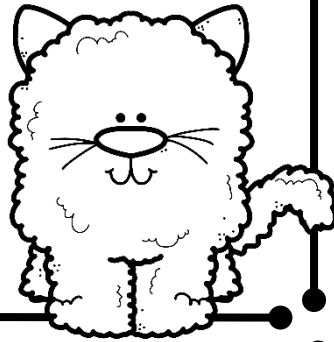
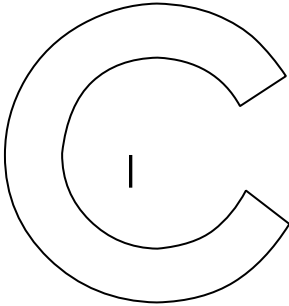

Read the words. Underline the c sound.

cat	cap	can
cot	cup	camel
carrot		car

Trace the letter.

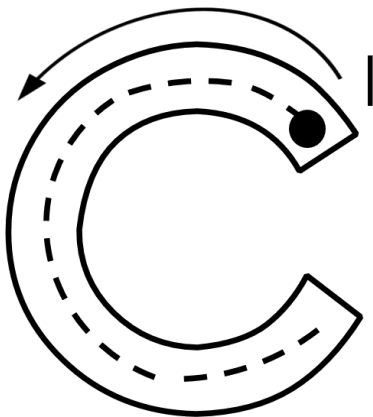

Colour the c sound.

p	c	o	n
n	d	n	c
c	o	c	n
o	n	m	d

Practice writing the letter.

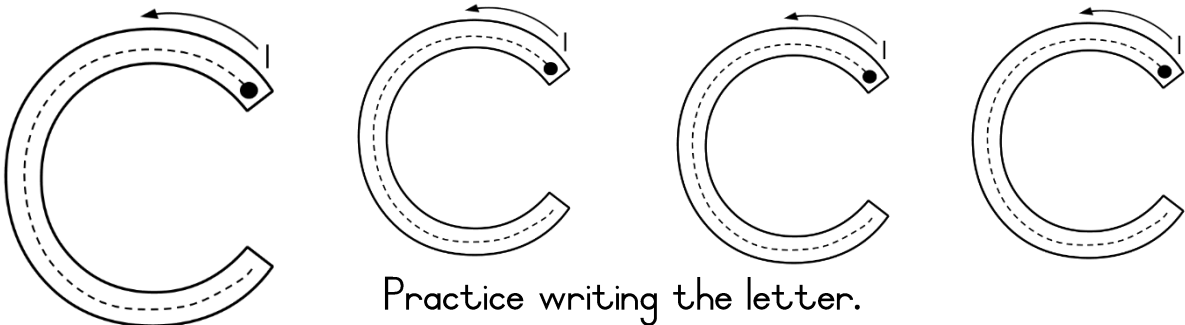
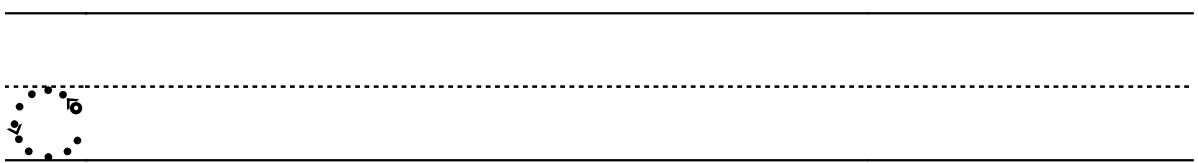

Practice writing the letter.

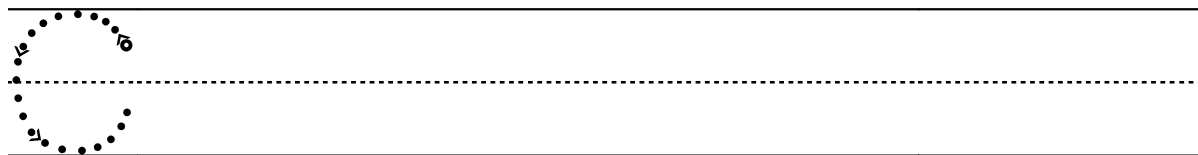

Fill in the letter c in the spaces so that the words match the pictures.

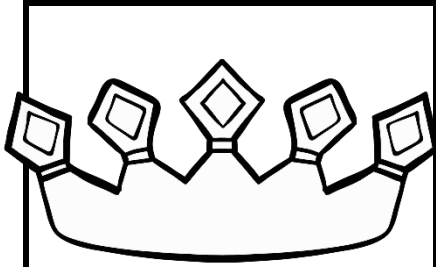

___rown

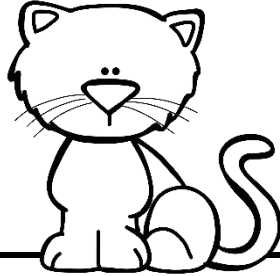

___at

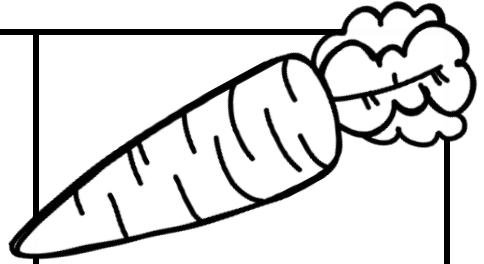

___arrot



___ake

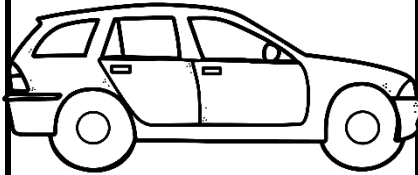

___ar

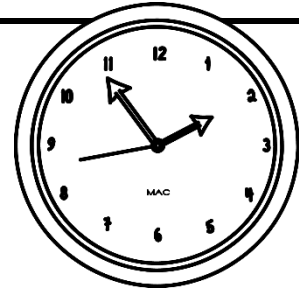

___lock

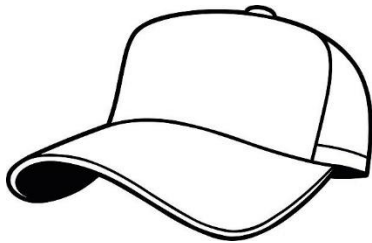

___ap

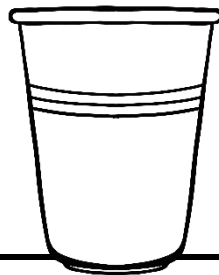

___up

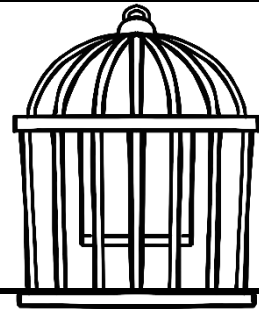

___age



___an



___andle

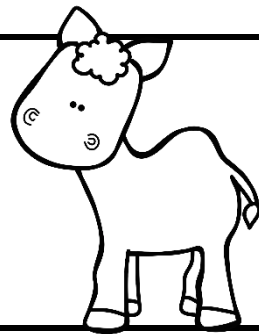

___amel

Colour the correct word.

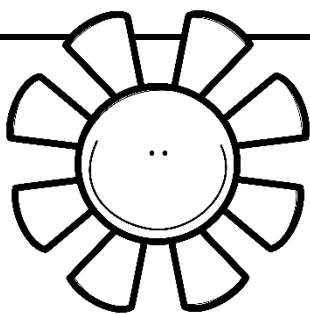

sun

suns

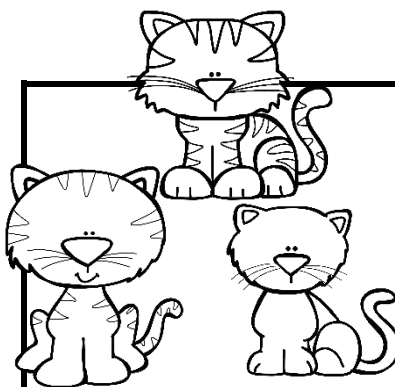

cats

cat



books

book

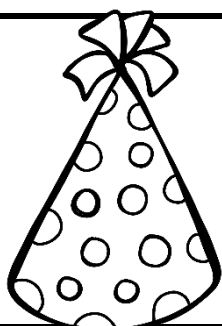

hats

hat

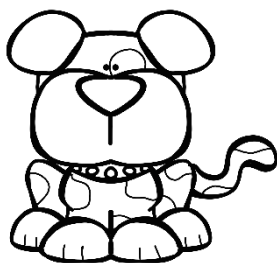

dog

dogs

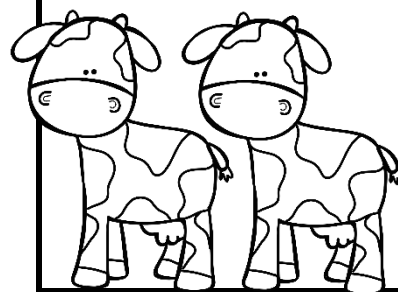

cows

cow

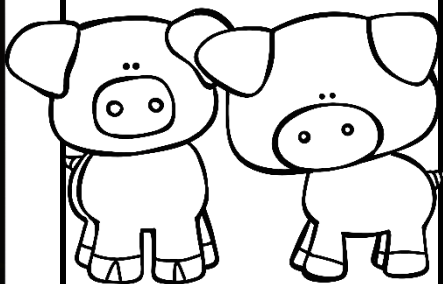

pigs

pig

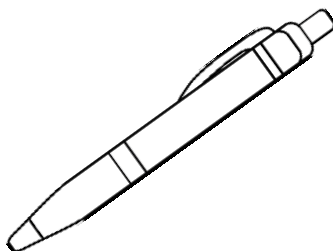

pen

pens

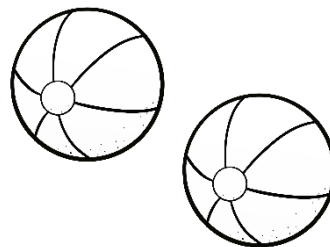

ball

balls

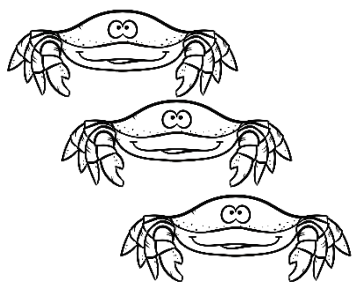

crab

crabs



trees

tree

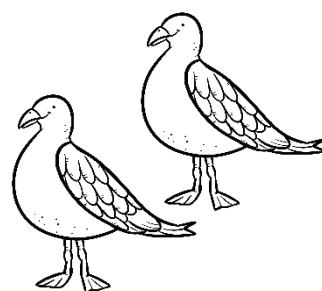

bird

birds

Colour the letter.

1 - orange

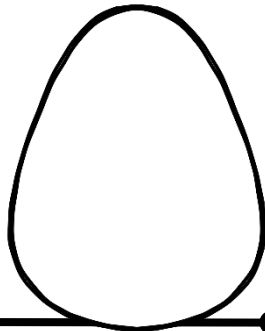
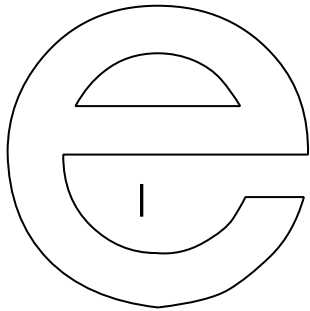

Read the words. Underline the e sound.

egg	elf	ten
men	hen	bed
elephant		

Trace the letter.

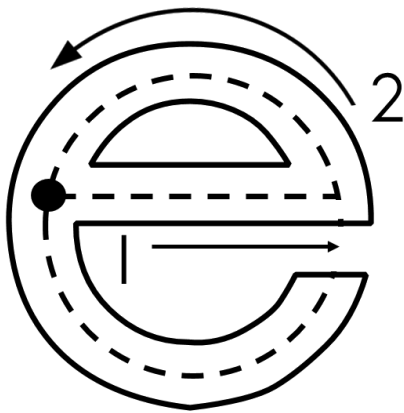

Colour the e sound.

e	c	o	n
e	d	e	c
c	o	c	e
o	e	m	d

Practice writing the letter.

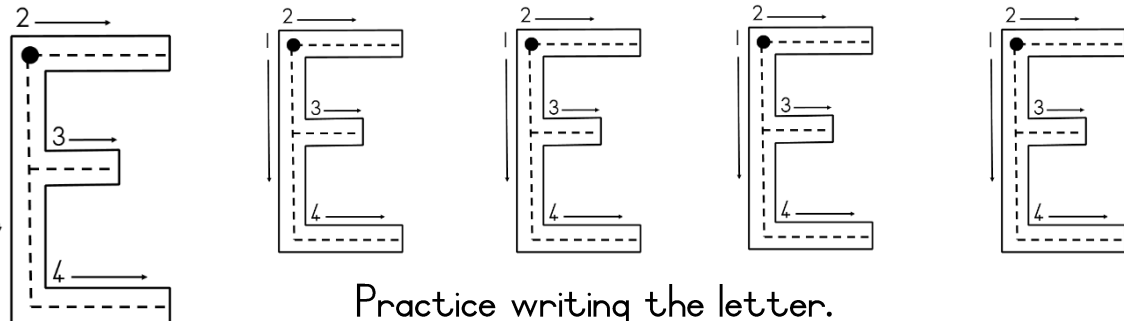
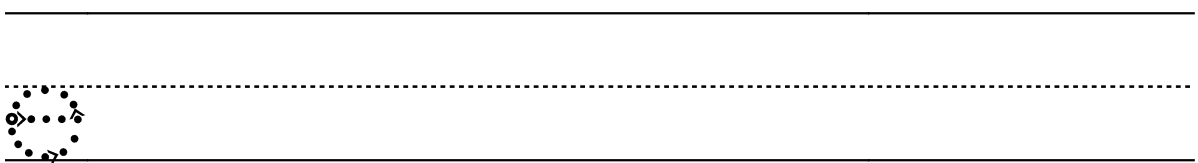

Practice writing the letter.

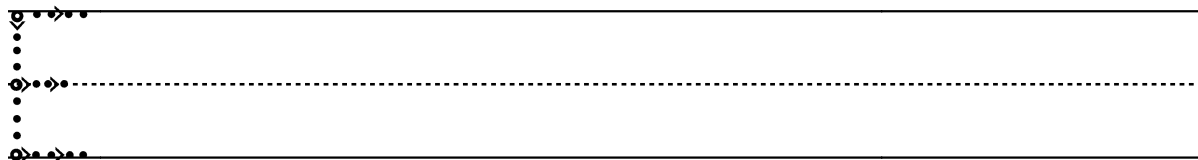

Colour the letter.

l - green

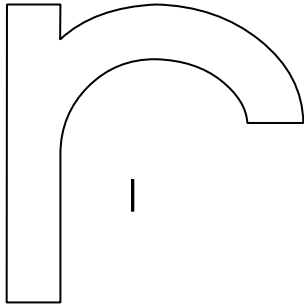

Read the words. Underline the r sound.

rat	red	run
rain	rope	ran
robot	rent	

Trace the letter.

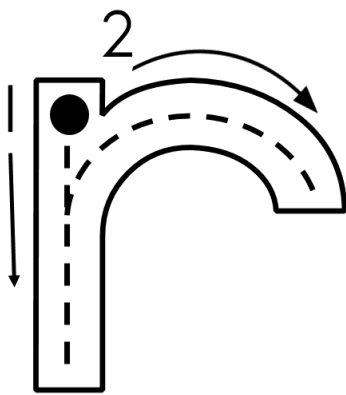

Colour the r sound.

e	c	o	n
e	r	e	c
r	o	c	r
o	e	r	d

Practice writing the letter.

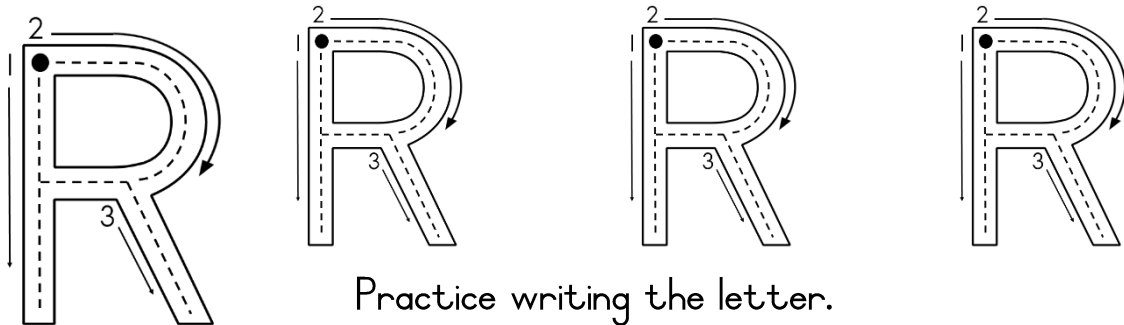
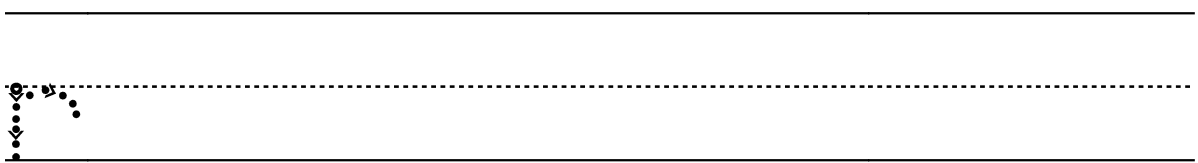

Practice writing the letter.

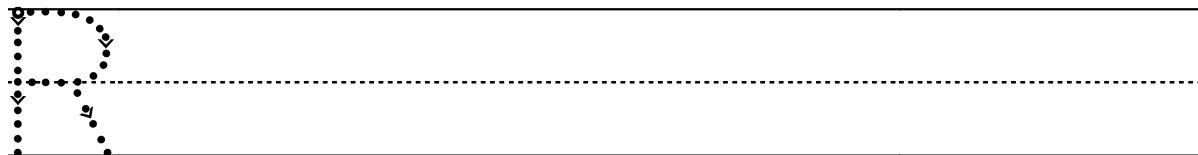

Fill in the letter e or r in the spaces so that the words match the pictures.

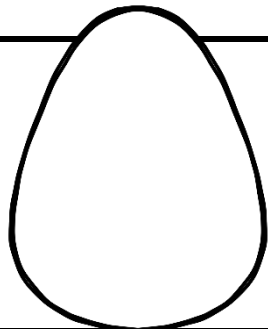

__gg

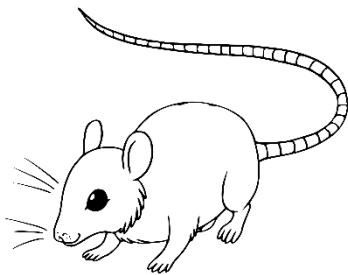

__at

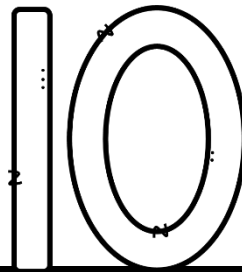

t__n

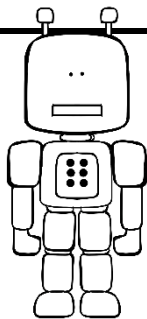

__obot

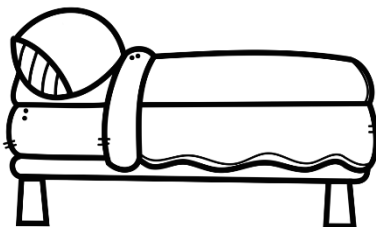

b__d



__ain

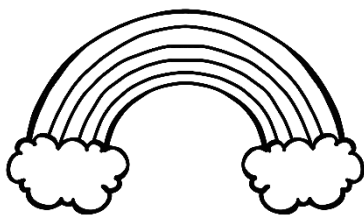

__ainbow



__un

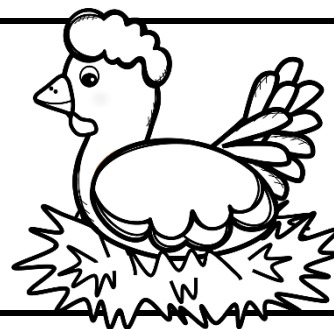

h__n

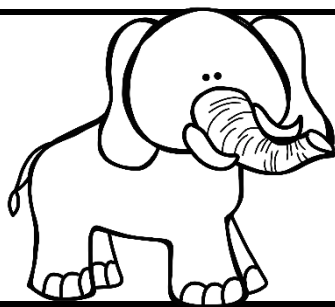

__lephant

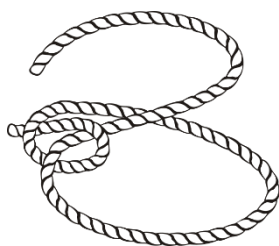

__ope



__lf

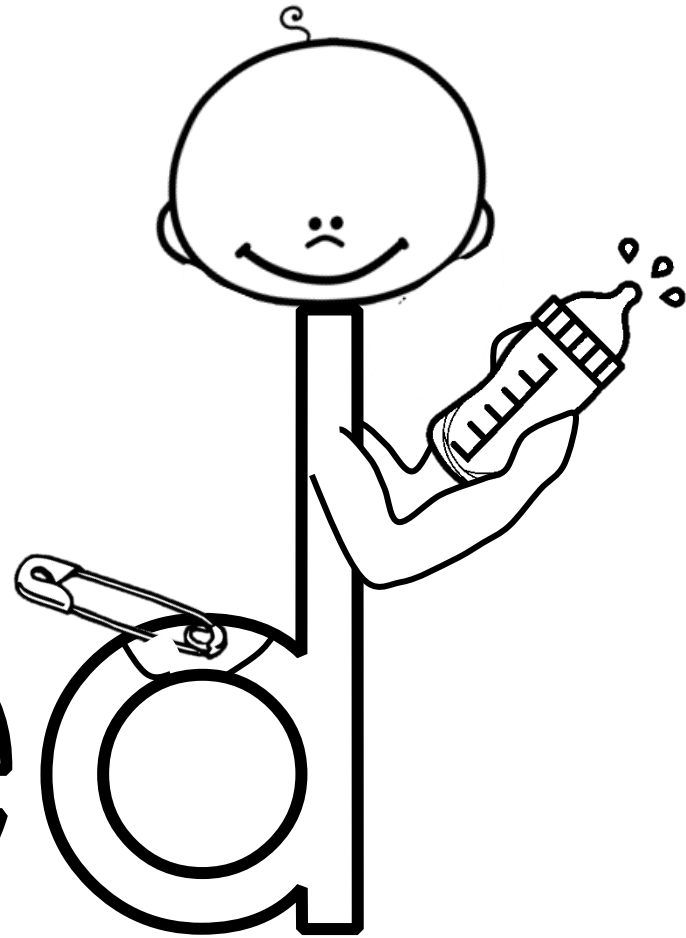
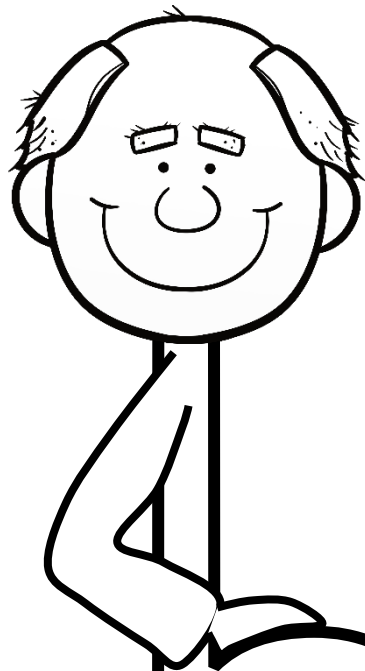

b e d

b has a belly

d has a diaper

Colour the letter.

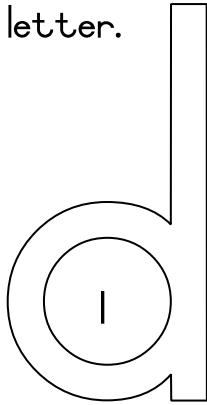

1 - red

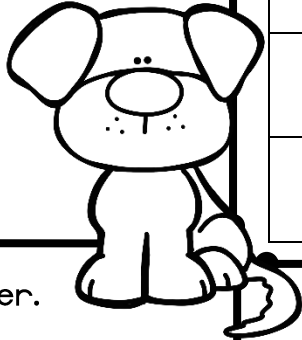

Read the words. Underline the d sound.

dog	did	dig
doll	dress	
donkey		

Trace the letter.

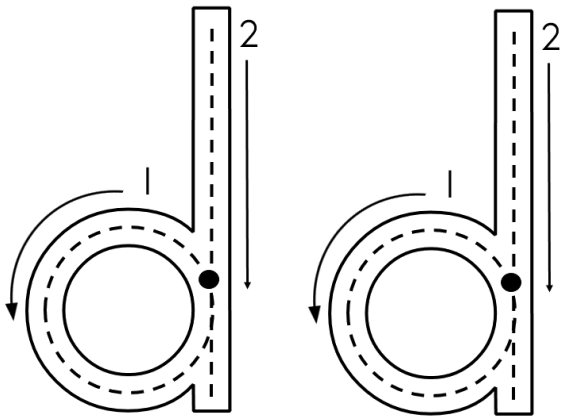

Colour the d sound.

p	b	p	d
b	d	p	b
d	p	d	b
d	b	p	d

Practice writing the letter.

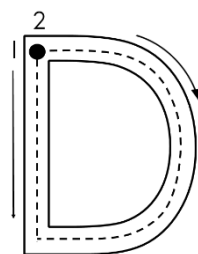
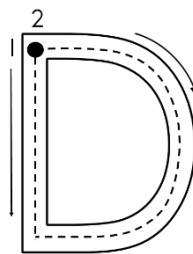
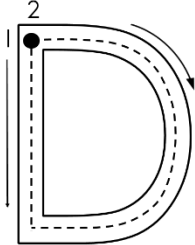
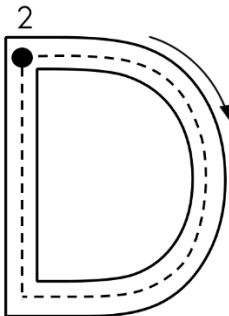
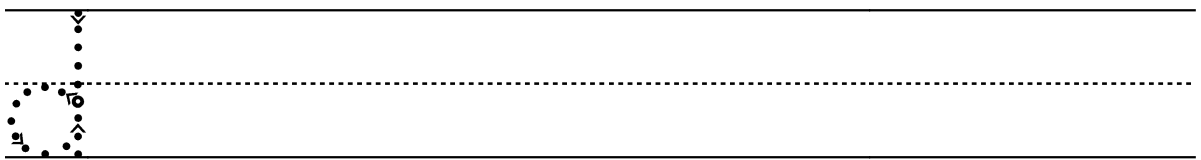

Practice writing the letter.

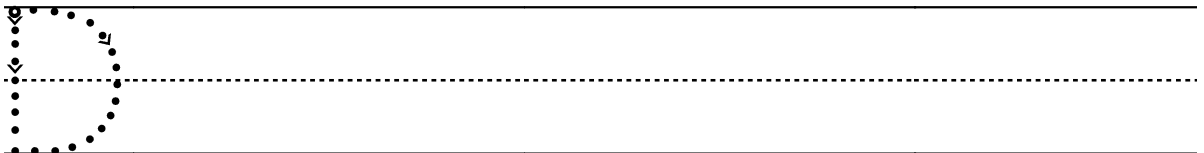

Colour the letter.

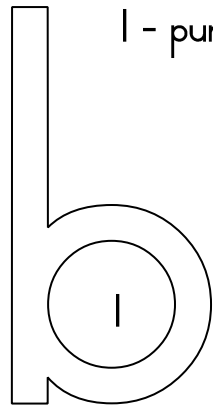
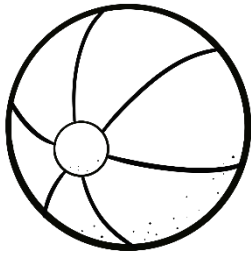

l - purple

Read the words. Underline the b sound.

bat	bed	bet
ball	bird	big
bread		bag

Trace the letter.

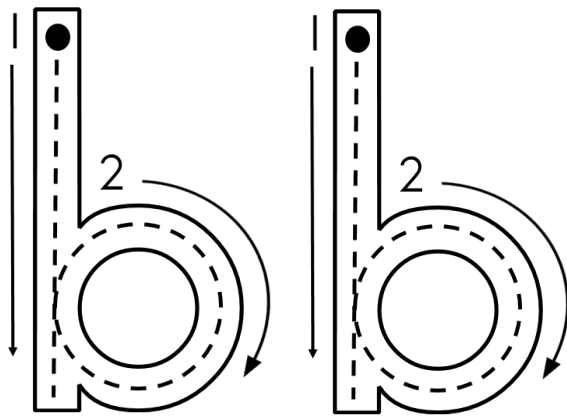

Colour the b sound.

p	b	p	d
b	d	p	b
d	p	d	b
d	b	p	d

Practice writing the letter.

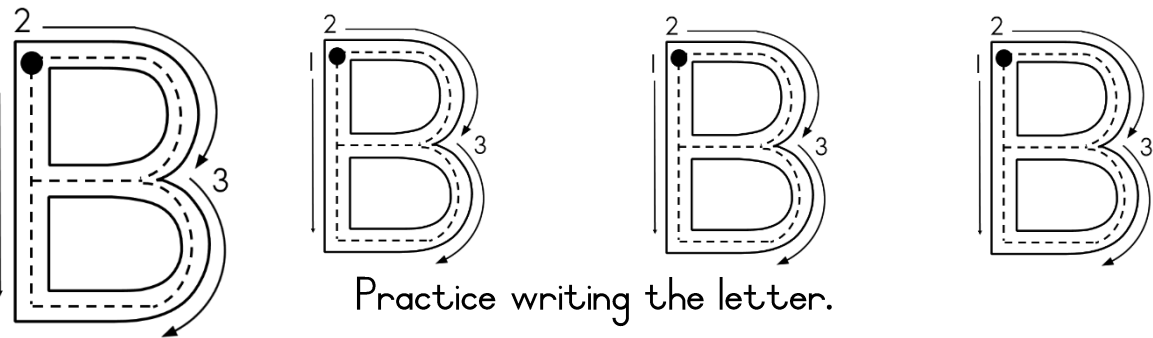
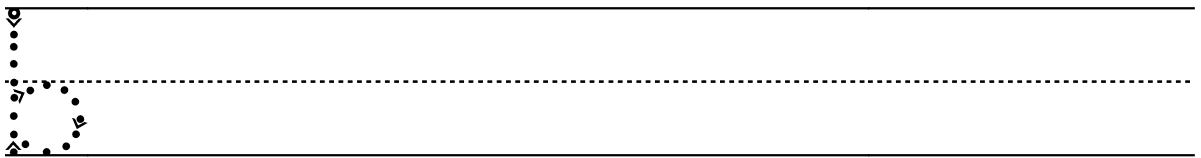

Practice writing the letter.

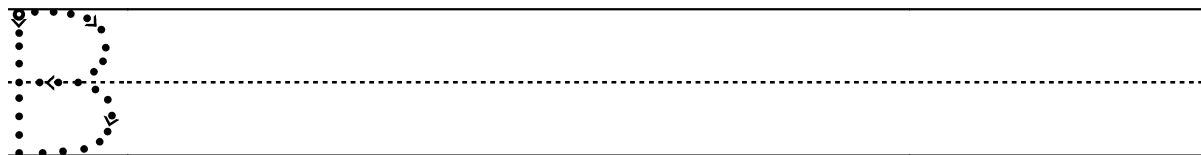

Fill in the letter **b** or **d** in the spaces so that the words match the pictures.

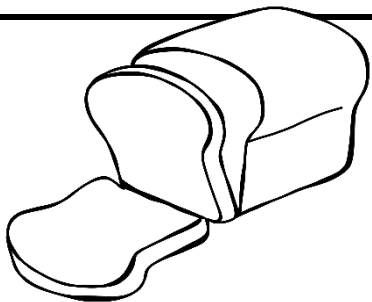

__rea__



__anana



__oll

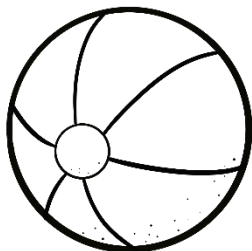

__all

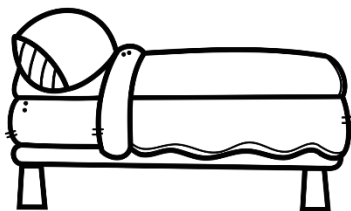

__e__

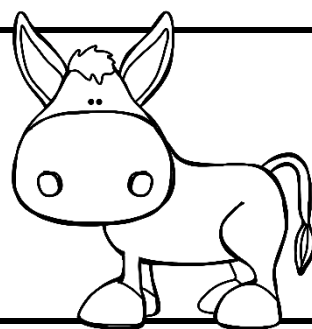

__onkey

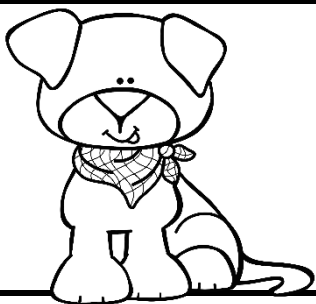

__og



__ress



__ag

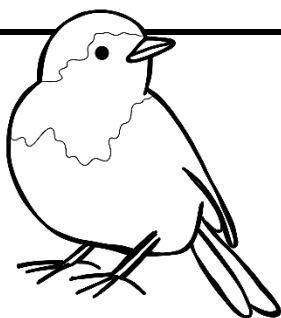

__ir__



__ig

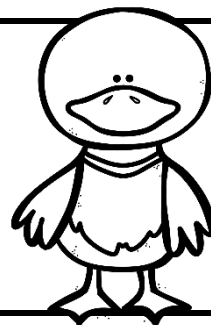

__uck

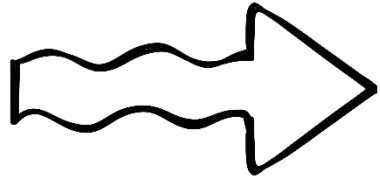

Syllables

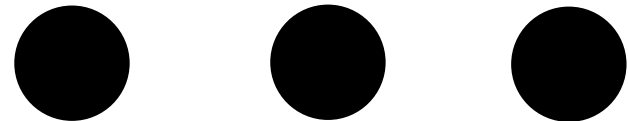
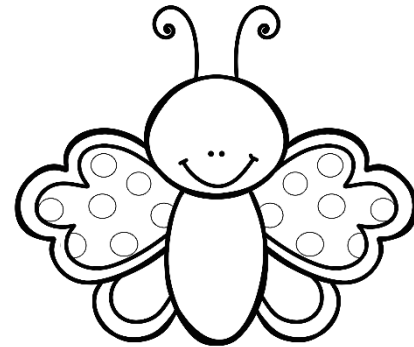
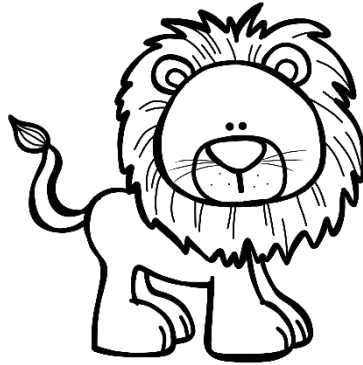
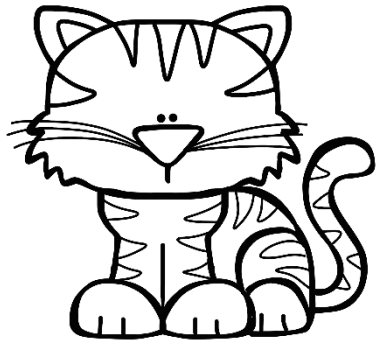
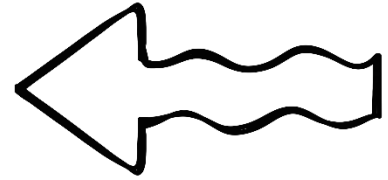

Clap the words.

Circle the amount of times you clapped.

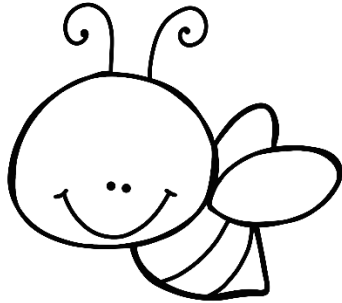

bee

1

2

3

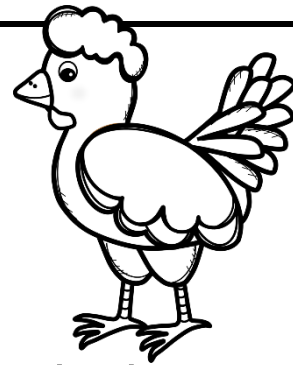

chicken

1

2

3

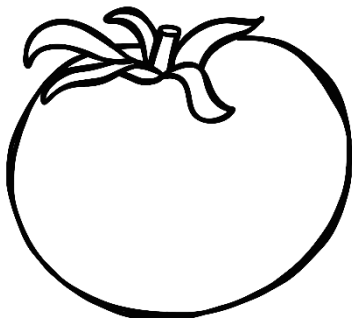

tomato

1

2

3

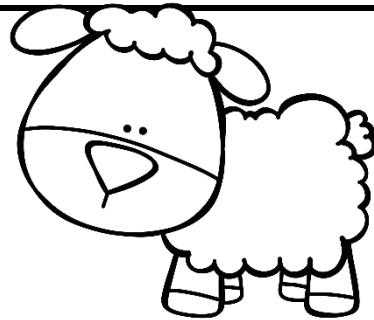

sheep

1

2

3

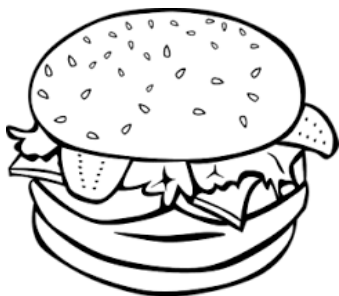

hamburger

1

2

3



tree

1

2

3

Clap the words.
Write it down.

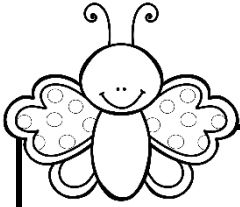

butterfly

but

ter

fly

ant

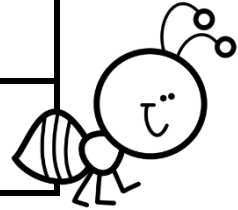

elephant



bird

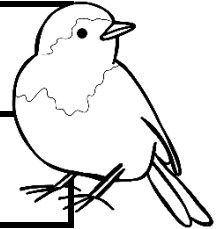

tomato

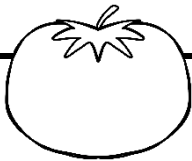

cat

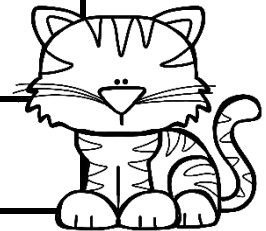

lion

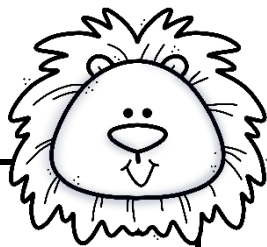

banana

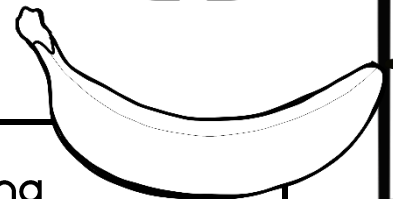

fish

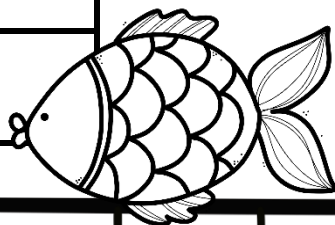

bunny

