

Graad 2
Afrikaans Huistaal
Kwartaal 4

bek

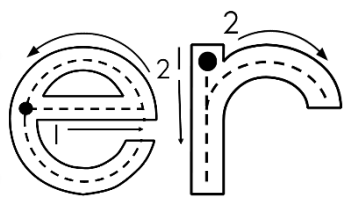

ket

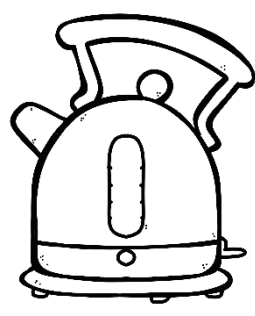
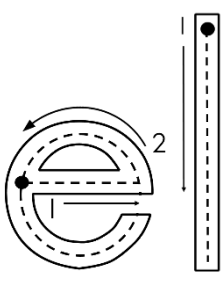

wol

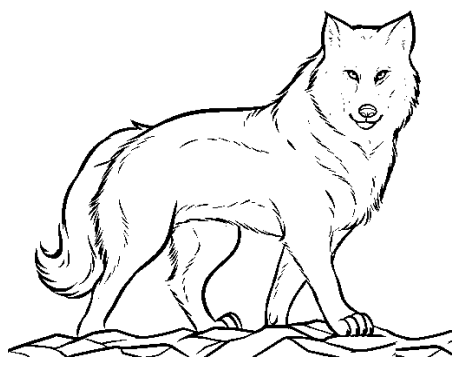
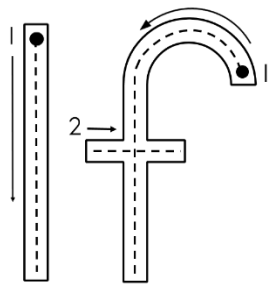

Naam en van:

Woorde wat eindig op -er

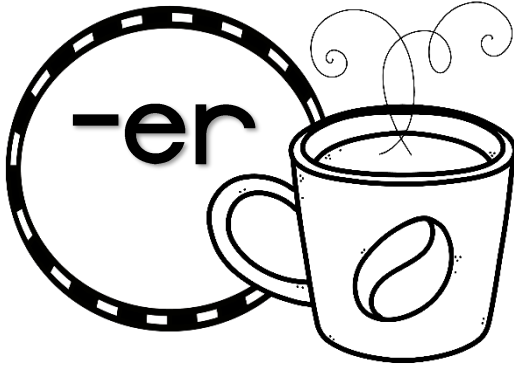

Onderstreep die er-klank.

nader	minder	sonder	beker
sommer	lekker	ander	stiller
donker	gouer	seker	soeter

Woorde wat eindig op -el

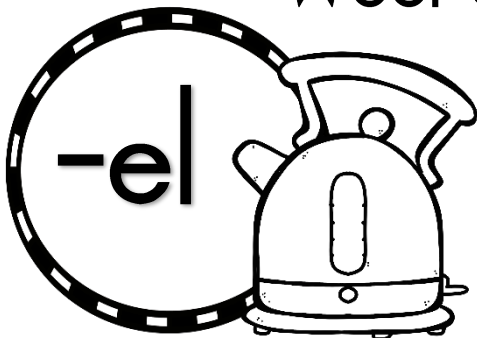

Onderstreep die el-klank.

ketel	bedel	sleutel
wafel	tafel	wortel

Woorde wat eindig op -ks

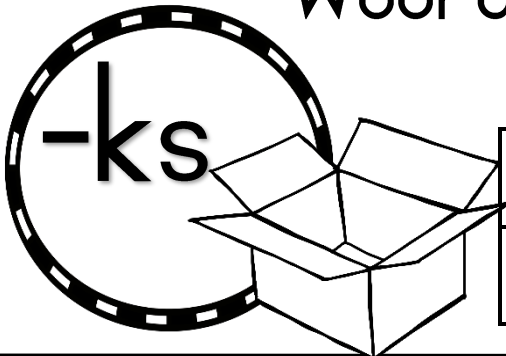

Onderstreep die ks-klank.

boks	fiks	fluks
niks	links	faks

Woorde wat eindig op -lf

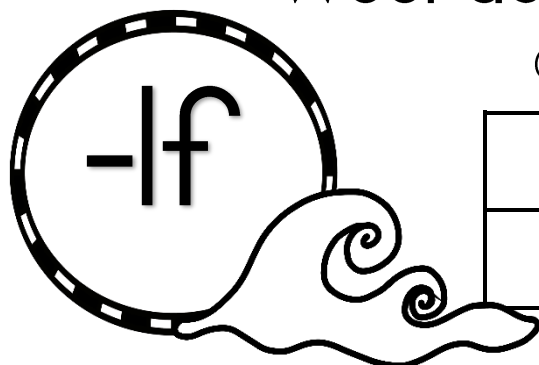

Onderstreep die lf-klank.

wolf	kalf	half
self	salf	golf

Woorde wat eindig op -lk

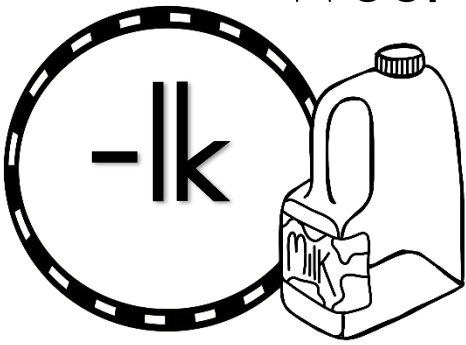

Onderstreep die lk-klank.

wolk	melk	balk
dalk	valk	kalk

Woorde wat eindig op -ld

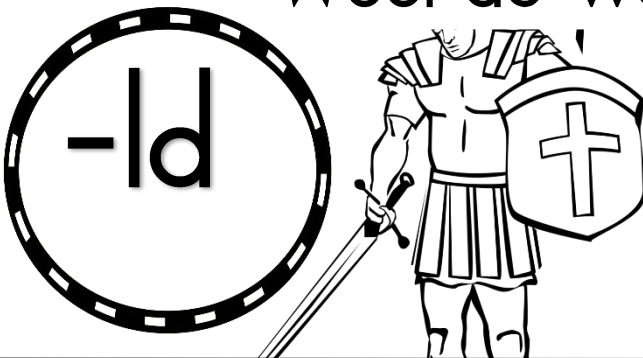

Onderstreep die ld-klank.

skild	veld	held	skuld
duld	speld	geld	naald

Woorde wat eindig op -lp

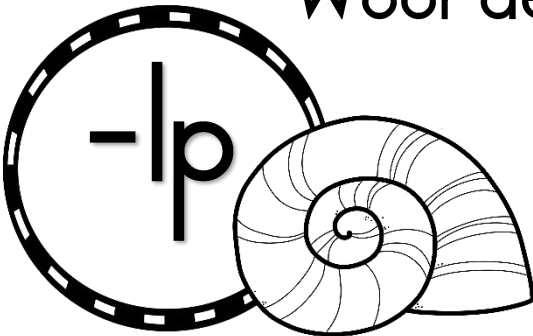

Onderstreep die lp-klank.

tulp	help
hulp	skulp

Woorde wat eindig op -mp

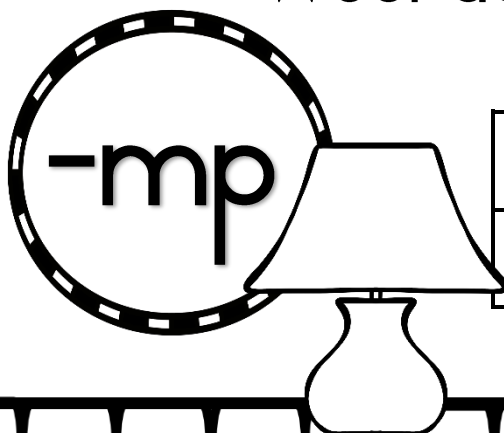

Onderstreep die mp-klank.

hemp	stomp	lamp	pomp
ramp	kamp	stamp	kamp

Woorde wat eindig op -ns

Onderstreep die ns-klank.

-ns

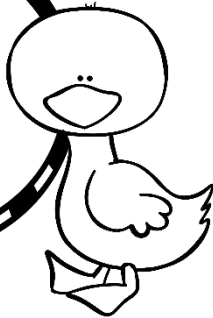

fons	dons	grens	kuns
pens	bons	gons	mens
gans	dans	guns	kans

Woorde wat eindig op -nt

Onderstreep die nt-klank.

-nt

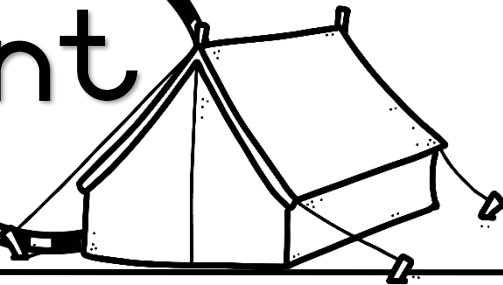

sent	punt	lint
prent	tent	want

Woorde wat eindig op -rg

Onderstreep die rg-klank.

-rg

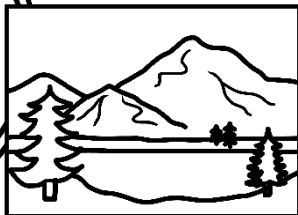

berg	wurg	sorg	verg
murg	erg	terg	

Woorde wat eindig op -rk

Onderstreep die rk-klank.

-rk



kerk	kurk	werk
vrk	merk	hark

Woorde wat eindig op -rt

-rt

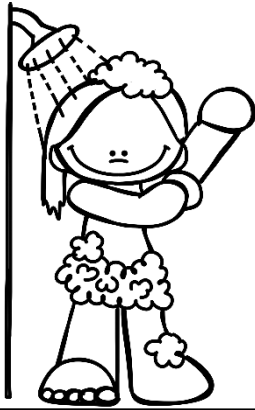

Onderstreek die rt-klank.

tert	hart	kort
kaart	vaart	stort

Woorde wat eindig op -ts

-ts

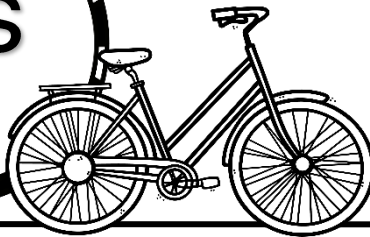

Onderstreek die ts-klank.

maats	fiets	bots
rats	iets	rots

Woorde wat eindig op -rm

-rm



Onderstreek die rm-klank.

arm	warm	kerm
swerm	derm	wurm

Woorde wat eindig op -lik

-lik



Onderstreek die lik-klank.

skielik	vriendelik	sieklik
eerlik	dadelik	maklik

Woorde wat eindig op -ing

-ing



Onderstreep die ing-klank.

ring	sing	spring	koning
bring	kring	doring	koring

Woorde wat eindig op -vol

-vol

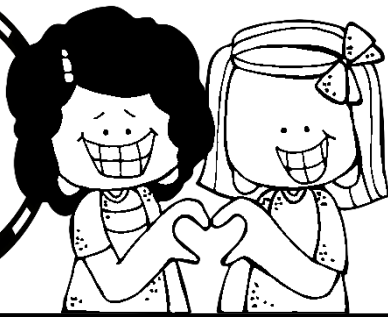

Onderstreep die vol-klank.

liefdevol	kleurvol
berouvol	smaakvol

Woorde wat eindig op -loos

-loos

Onderstreep die loos-klank.

grensloos	smaakloos	vreesloos
doelloos	geurloos	spoorloos

Woorde wat eindig op -baar

-baar



Onderstreep die baar-klank.

leesbaar	bruikbaar
eetbaar	breekbaar

Woorde wat eindig op -ste

Onderstreep die ste-klank.

-ste

stoutste	slimste	mooiste
grootste	langste	sterkste

Woorde wat eindig op -ies

Onderstreep die ies-klank.

-ies

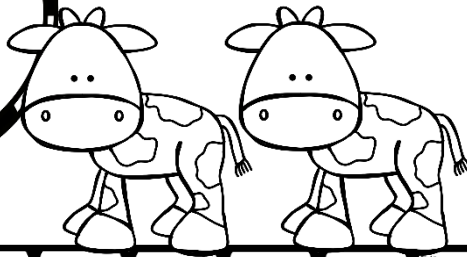

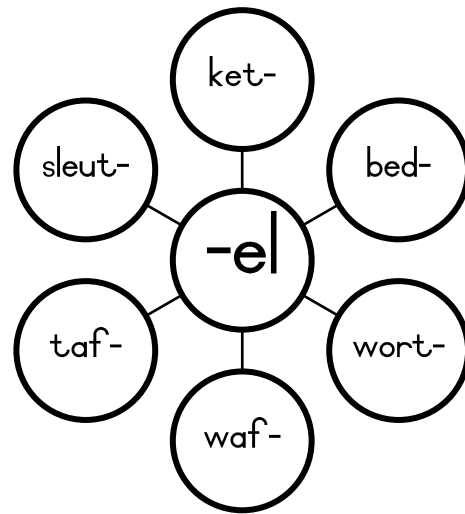
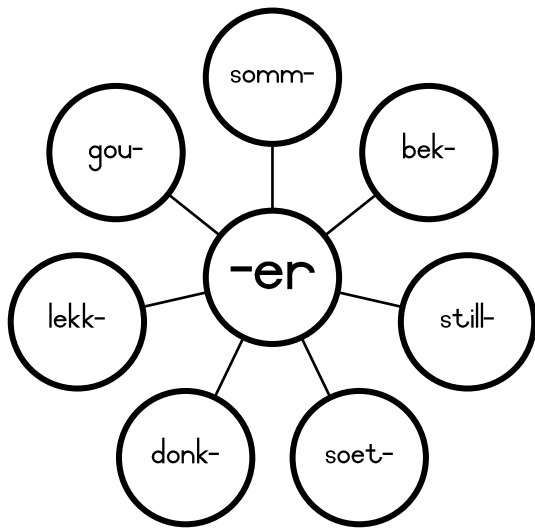

bokkies	vlaggies
saggies	kalfies



Bou die woorde en skryf dit in die tabel.

-er	-el

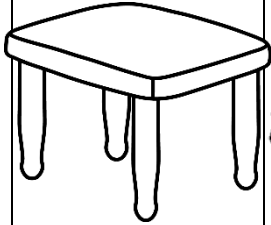
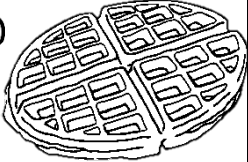
Skryf die naam vir die prent.

				

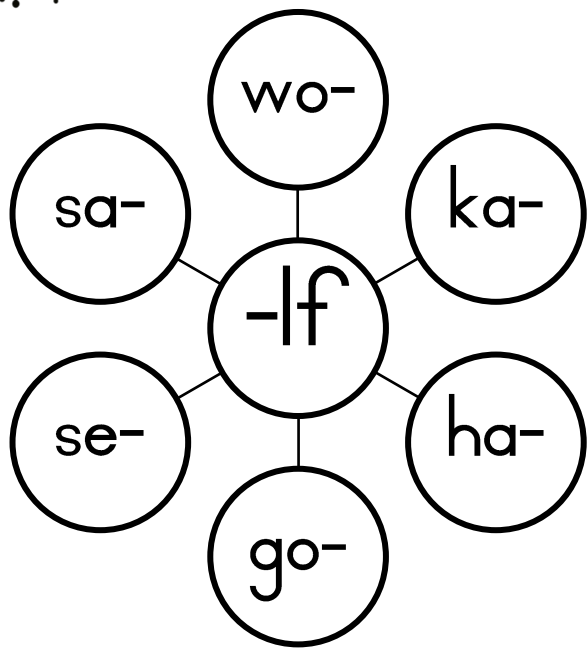

Bou die woorde en skryf dit in die tabel.

-lf	

Skryf die naam vir die prent.

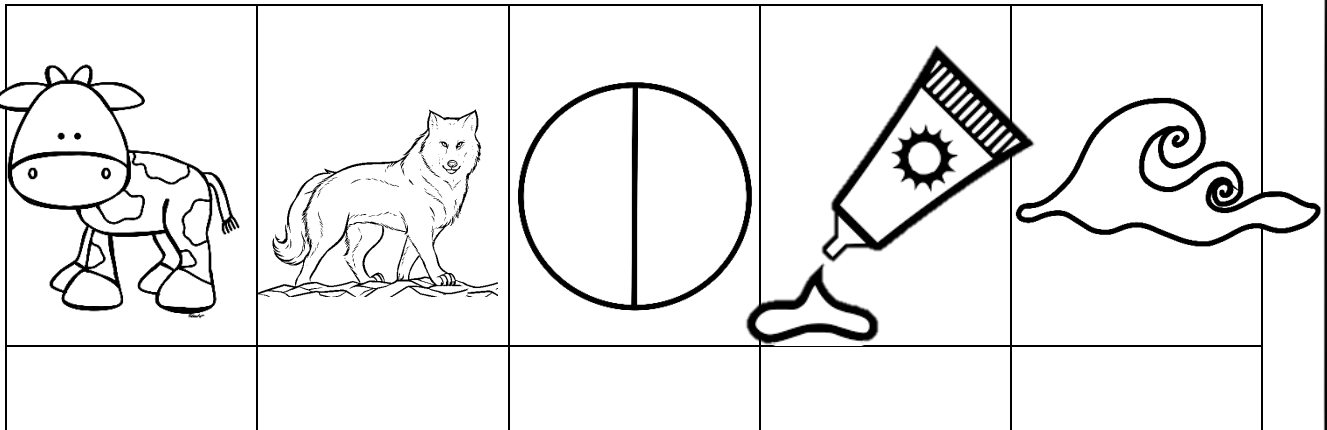

a	s	k	a	l	f
s	e	l	f	o	w
s	q	p	o	l	o
a	g	o	l	f	l
l	w	e	r	k	f
f	h	a	r	t	l
h	a	l	f	k	o

Soek die woorde en kleur dit in.

self
salf
wolf
kalf
half
golf

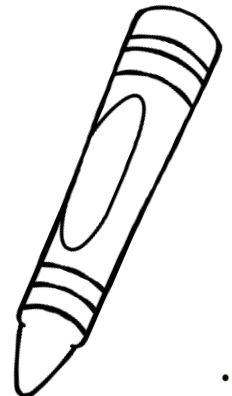

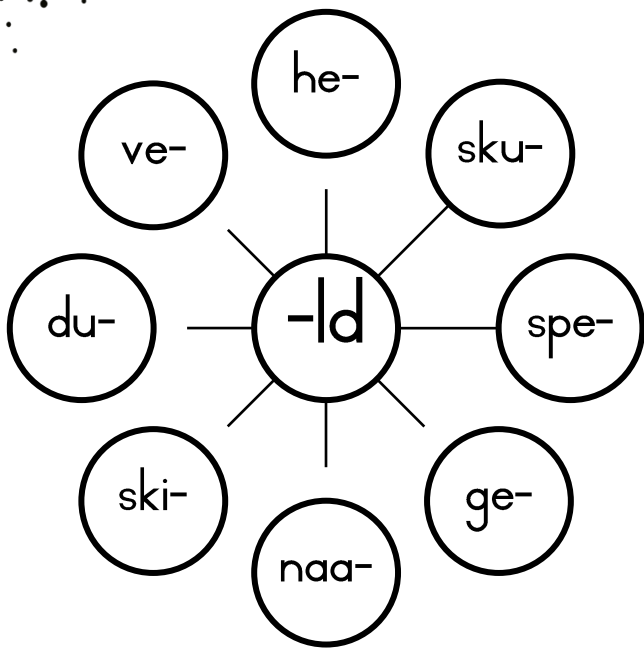



Bou die woorde en skryf dit in die tabel.

-ld	

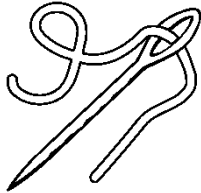
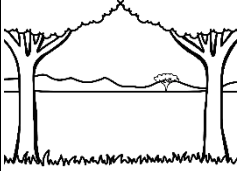
Skryf die naam vir die prent.

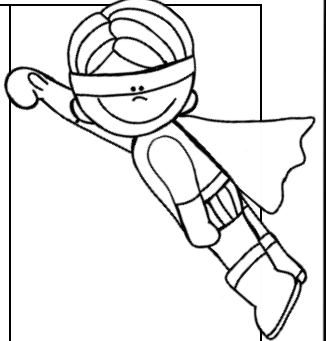

s	s	p	e	l	d
k	e	l	f	o	w
u	g	e	l	d	d
l	v	o	l	h	u
d	e	e	r	e	l
f	l	a	r	l	d
h	d	l	f	d	o

Soek die woorde en kleur dit in.

held
veld
geld
speld
duld
skuld

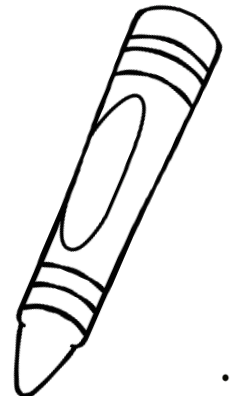

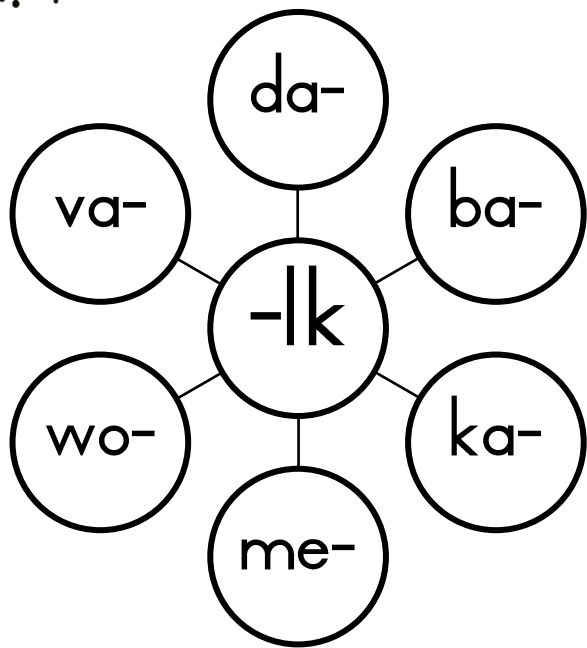

Bou die woorde en skryf dit in die tabel.

-lk	

Skryf die naam vir die prent.

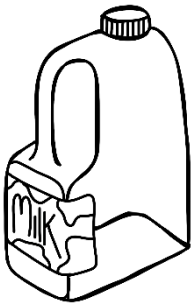
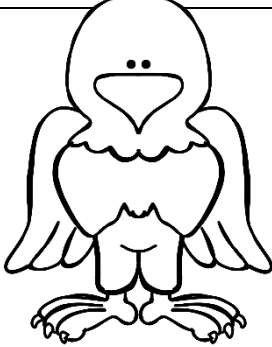
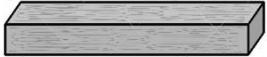
s	s	d	a	l	k
b	a	l	k	o	w
u	g	e	l	d	d
k	a	l	k	w	v
d	e	e	r	o	a
f	l	a	r	l	l
m	e	l	k	k	k

Soek die woorde en kleur dit in.

- melk
- wolk
- balk
- kalk
- dalk
- valk

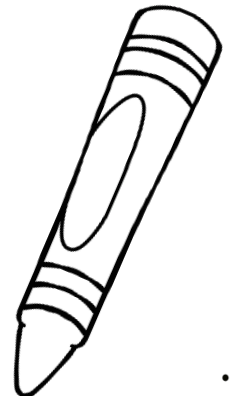

he-

tu-

-lp

hu-

sku-

Bou die woorde en skryf dit in die tabel.

-lp	

Skryf die naam vir die prent.

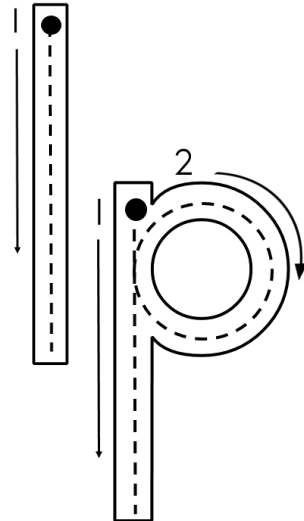
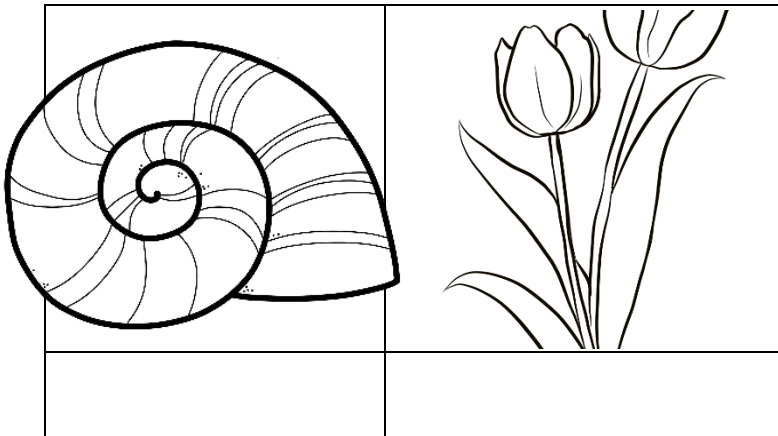

s	s	d	a	l	k
t	a	h	u	l	p
u	g	e	l	d	d
l	s	k	u	l	p
p	e	e	r	o	a
f	h	e	l	p	l
m	e	l	k	k	k

Soek die woorde en kleur dit in.

- help
- hulp
- skulp
- tulp

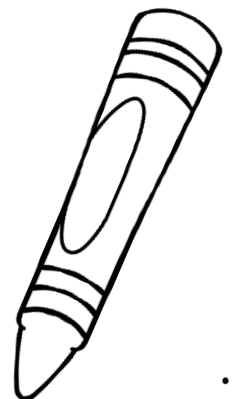

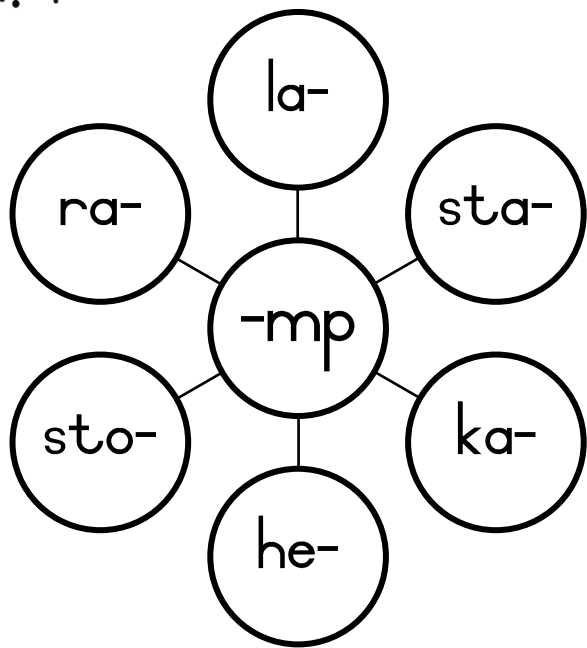



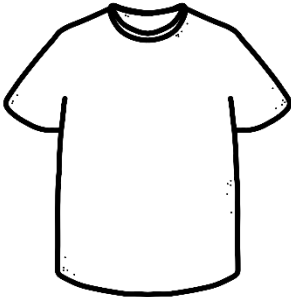

Bou die woorde en skryf dit in die tabel.

-mp	

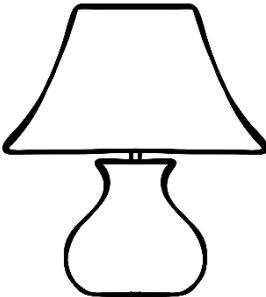
Skryf die naam vir die prent.

h	e	m	p	s	s
b	a	l	k	t	t
l	g	r	l	a	o
o	a	a	k	m	m
m	e	m	r	p	p
p	l	p	r	l	l
m	k	a	m	p	k

Soek die woorde en kleur dit in.

- hemp
- lomp
- stomp
- kamp
- stamp
- ramp

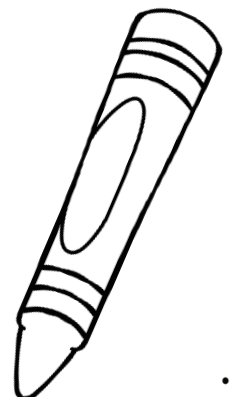

Kleur die prent volgens die kode in.

-nt  geel

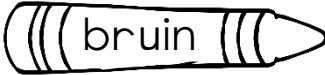
-ks  bruin

-ns  groen

-ts  blou

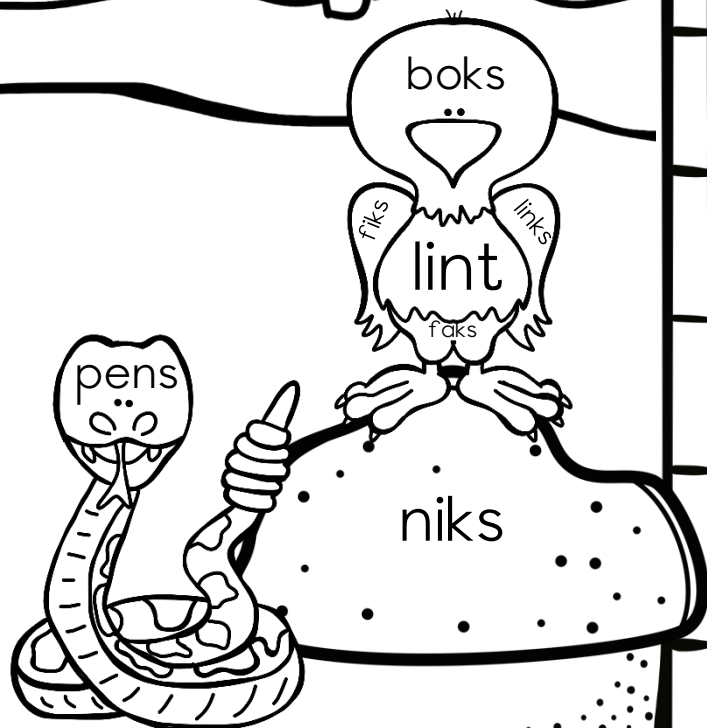
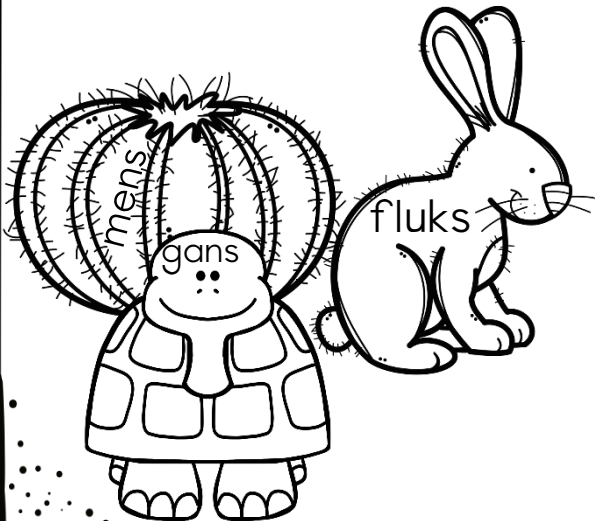
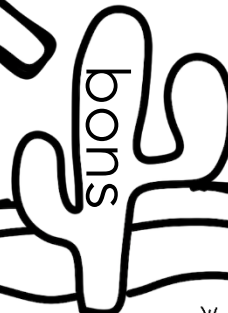
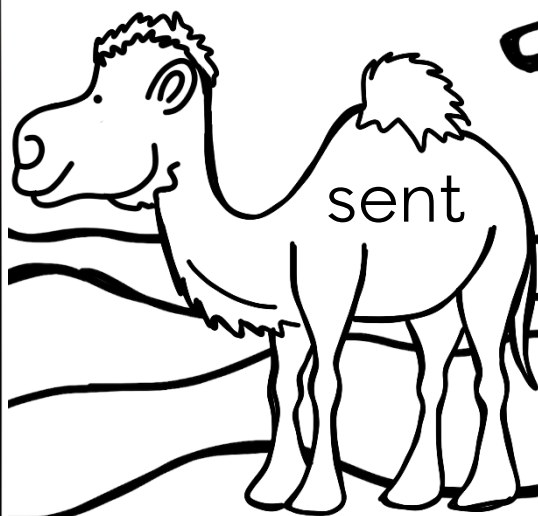
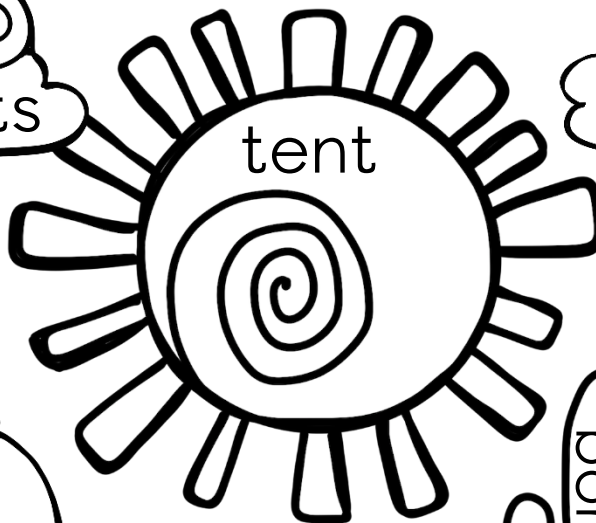

Sê die prent se naam. Luister na die klank en vul die regte klank in waarmee die woorde eindig.



ka___

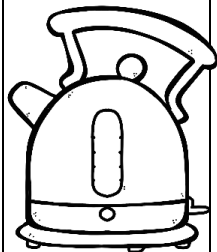

ket___

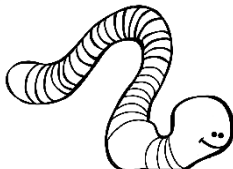

wu___

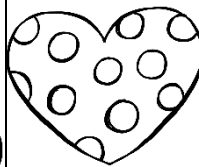

ha___

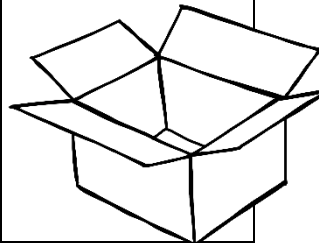

bo___

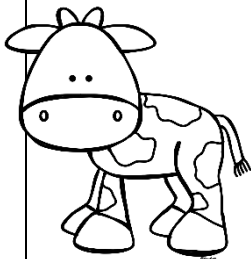

ka___



se___

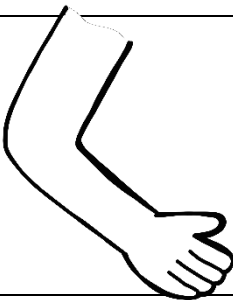

a___

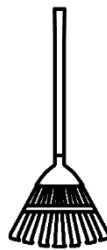

ha___



wo___

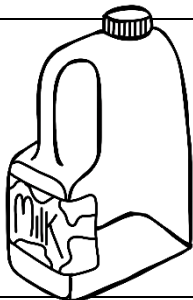

me___

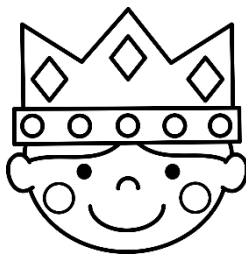

kon___



sta___



go___

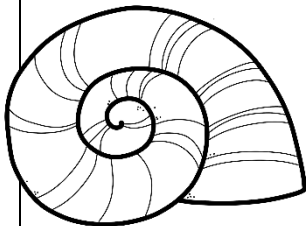

sku___

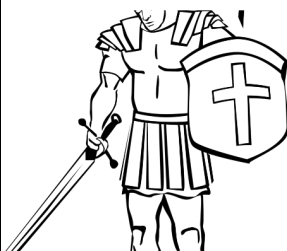

ski___

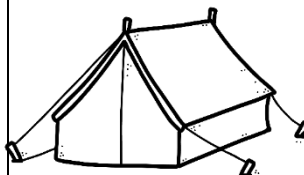

te___

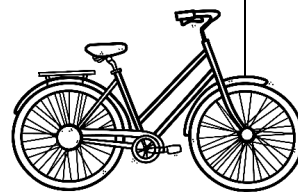

fie___

Voornaamwoorde

Gebruik die voornaamwoorde in die sirkels om die sinne te voltooi.

1. Hy het _____ huiswerk gedoen.
2. Ek lees _____ boek.
3. Sy het _____ boek skool toe geneem.
4. Ons het _____ boeke.
5. Hulle het _____ aandete geëet.
6. Ek het _____ middagete geëet.
7. Jy moet _____ huiswerk doen.
8. Ons het _____ huiswerk gedoen.
9. Sy soek _____ potlood.
10. Jy het _____ potlood.
11. Hy het volpunte vir _____ toets gekry.
12. Hulle het _____ huiswerk gedoen.

'n Voornaamwoord
staan in die plek van
'n naamwoord.

jou

haar

ons

my

sy

hulle

Lees elke sin en onderstreep die regte woord.

1. Jana wil vir haar/sy 'n nuwe rok koop.
2. Jana en haar ma dink dat hulle/haar 'n mooi rok sal kry.
3. Dit/sy is 'n mooi pienk rok.
4. Klara is ook by die winkel en kom spog met sy/haar nuwe, pers rok.
5. Jana en Klara is baie bly, want haar/hulle het ... nuwe rokke gekry.

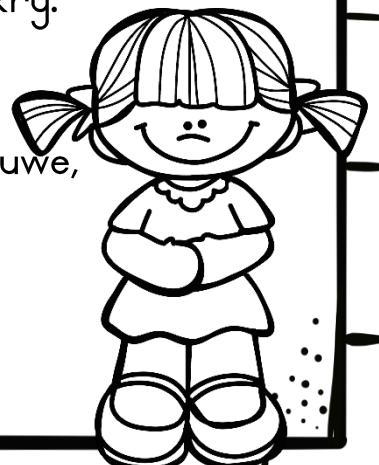

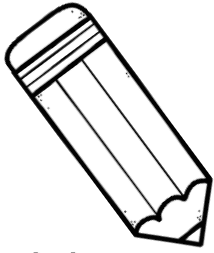

Verlede tyd

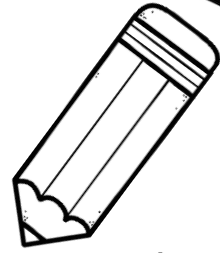

Wanneer ge- voor aan 'n doenwoord geheg word, beteken dit die aksie het klaar gebeur.

Skryf die sin in die verlede tyd. Die eerste een is vir jou gedoen. Onderstreep die doenwoord wat in die verlede tyd is.

Klara en Ben speel in die parkie.

Gister het Klara en Ben in die parkie gespeel.

Hannes skop die bal baie hard.

Mia koop nuwe skoene.

Jan verf 'n mooi prent.

Jana eet sjokolade koek.

Janu loop skool toe.

Werkwoorde

Werkwoorde is aksiewoorde of doenwoorde. Dit vertel vir ons wat gebeur.

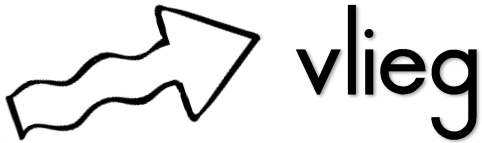

vlieg

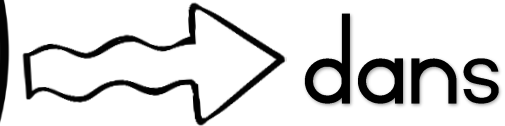

dans

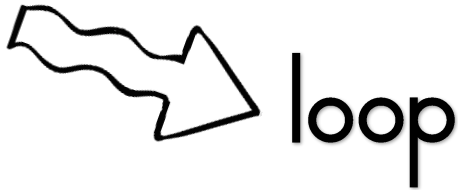

loop

Onderstreep die doenwoord.

Trek dan 'n kring om die persoon of ding wat iets doen.



Die meisie sing.



Die seun skop die bal.

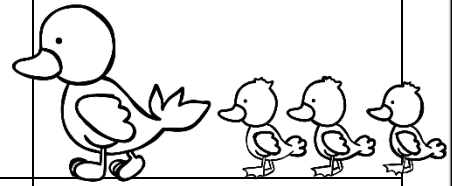

Die eende loop in 'n ry.



Die seun verf.

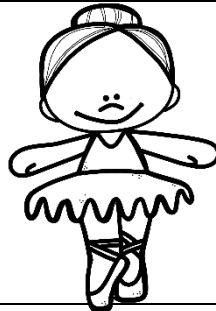

Die meisie dans.

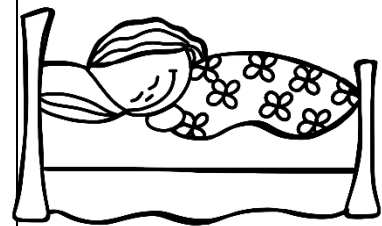

Die meisie slaap.

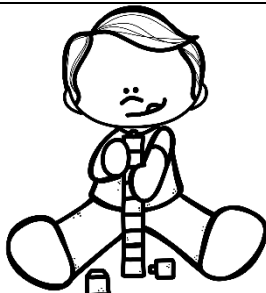

Die seun bou blokkies.



Die hond eet sy kos.



Die seun hardloop.

Antonieme

Antonieme is
woorde met die
teenoorgestelde
betekenis, bv.
mooi - lelik

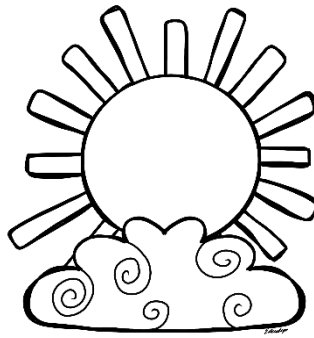

dag

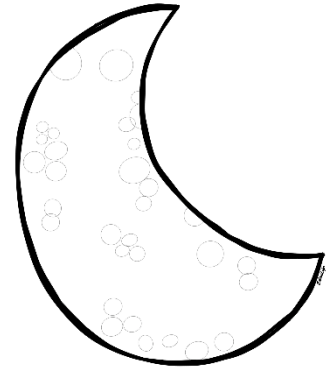

nag

Verbind die woorde in die kolom links met sy teenoorgestelde
in die kolom regs.

op

kom

stadig

nuut

dag

uit

hartseer

nee

lank

gelukkig

nag

kort

in

oud

ja

gaan

vinnig

af

yslik

Sinonieme

groot

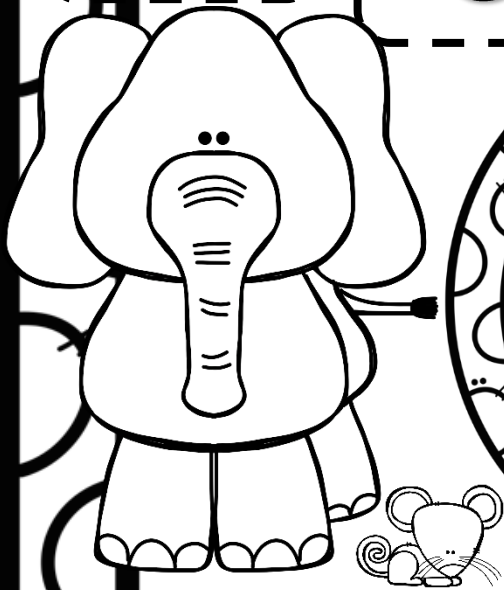

'n Sinoniem is 'n woord wat dieselfde betekenis as 'n ander woord het.



Verbind die woorde in die kolom links met sy sinoniem in die kolom regs.

verspot
lank
pad
gelukkig
kyk
gou
verniet
praat
present
meisie
yslik

bly
groot
uitgereek
sien
laf
dogter
geskenk
gratis
vinnig
gesels
straat



Verskillende tipe sinne

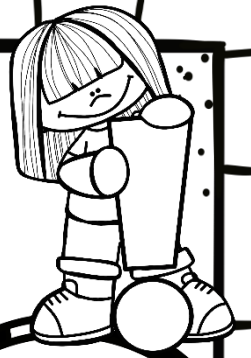

Stelsin

Ons sit 'n punt agter 'n sin wat iets vertel. (.)



Vraagsin:

Ons sit 'n vraagteken agter 'n vraag. (?)



Bewoan

Ons sit 'n uitroepteken aan die einde van 'n sin as daar vir jou gesê word om iets te doen. (!)

Uitroepsin

Ons sit 'n uitroepteken agter 'n sin as daar opgewondenheid is. (!)

Skryf neer watter tipe sin dit is. Skryf dan die sin oor met die regte leestekens. Die eerste een is vir jou gedoen.

ek hou van roomys

Ek hou van roomys.

stelsin

hou jy van roomys

kom hier

oppas daar is 'n slang

klara en jan is my maats

help my