

Graad /

Pret pakkie

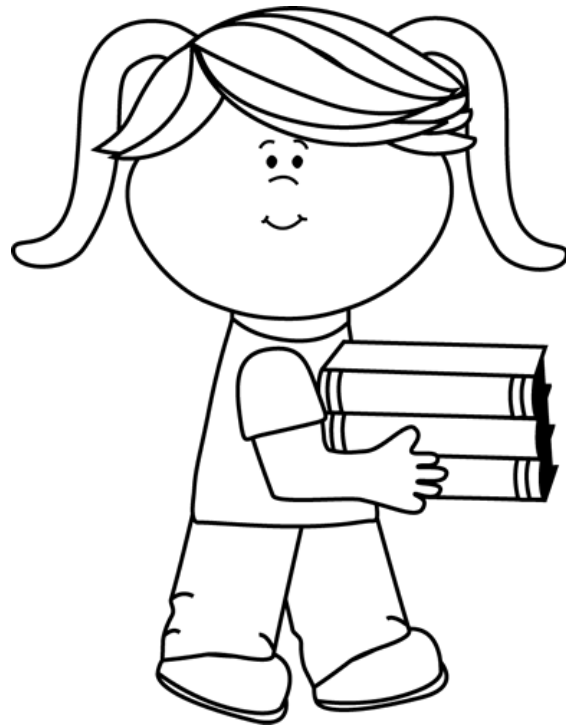

Naam:

Help Skillie skilpad om
op die ballonne se
stippellyne te knip.

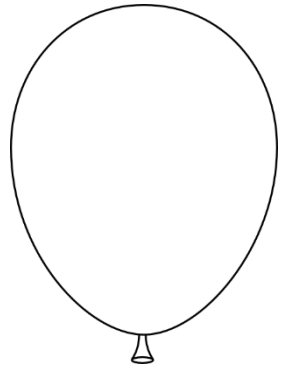
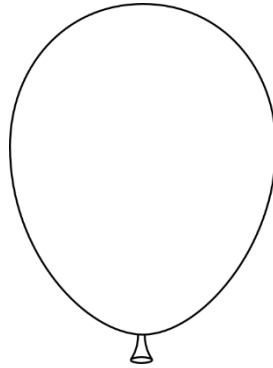
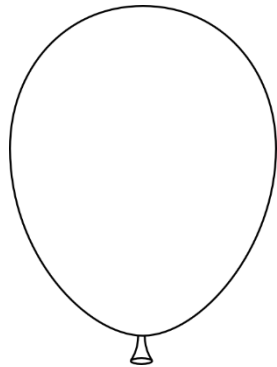
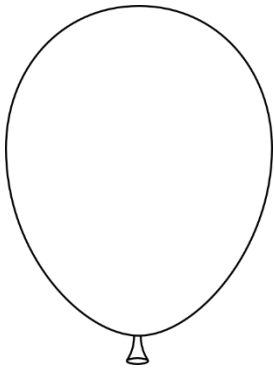
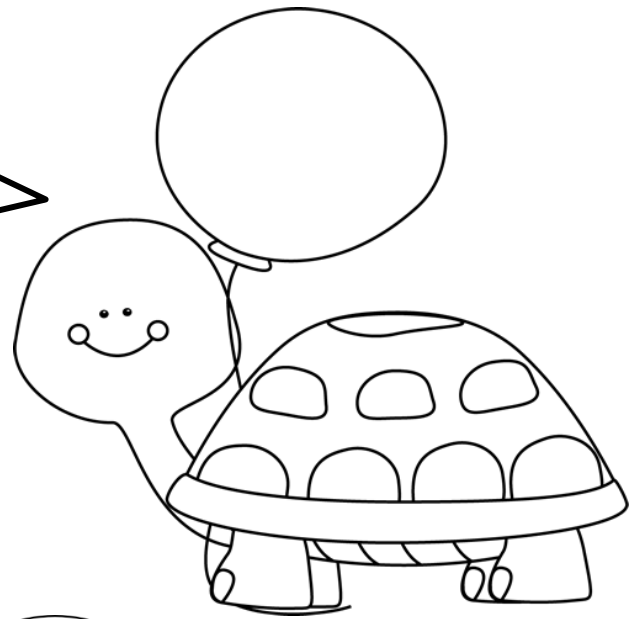

Kom ons knip!
Knip die vierkant uit.

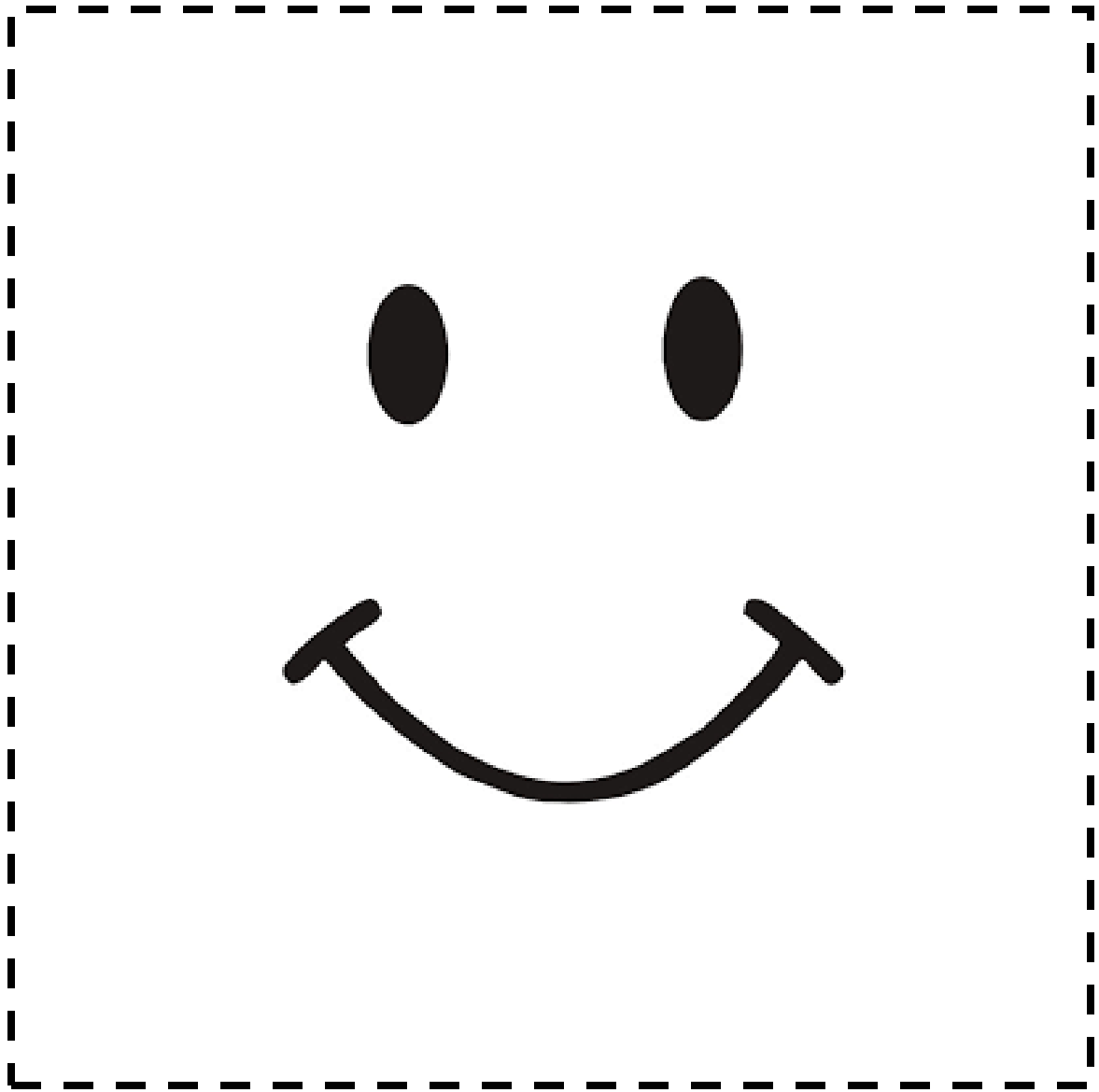

Kom ons knip!
Knip die sirkel uit.

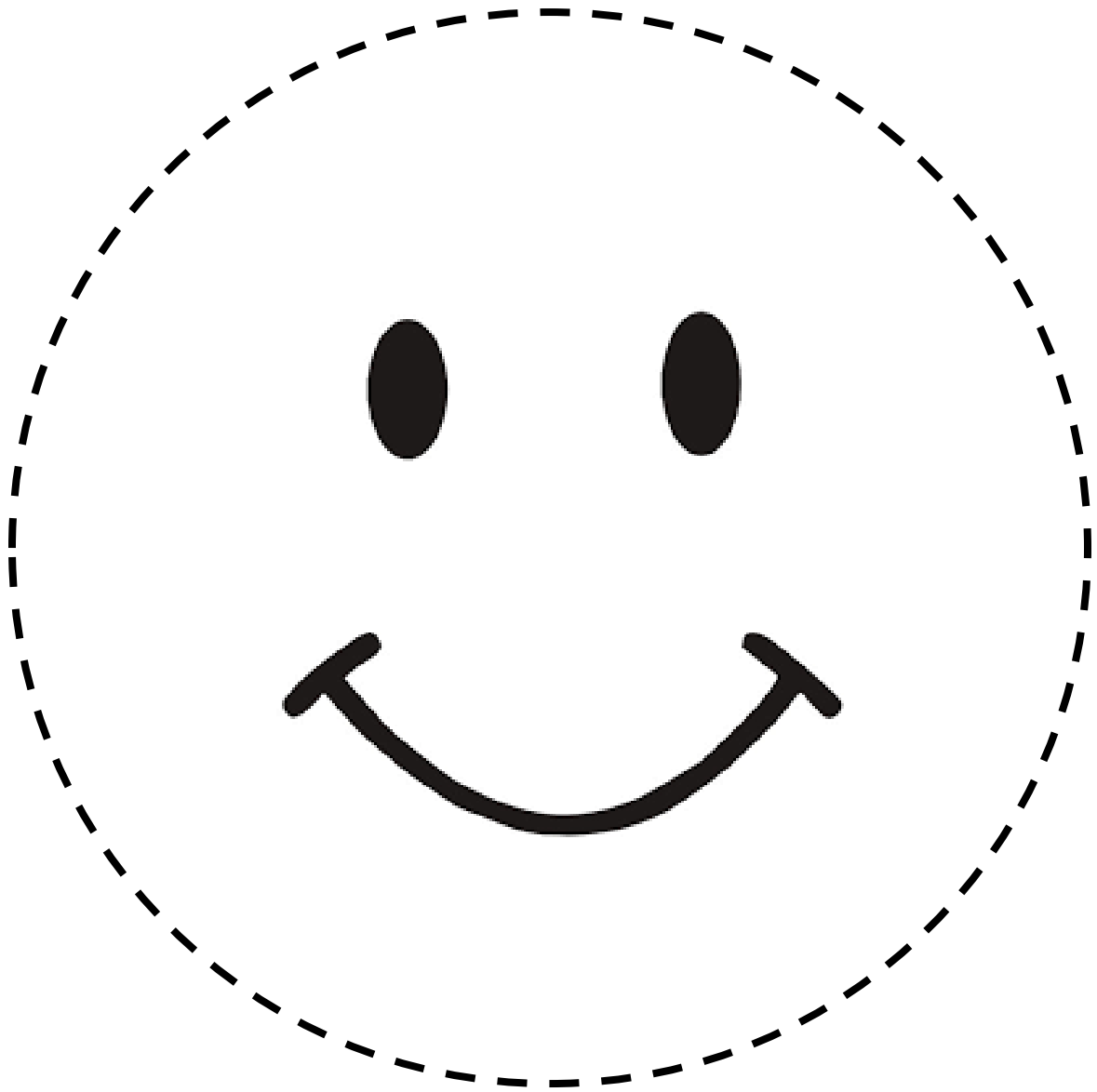

Kom ons oefen
die sirkel.

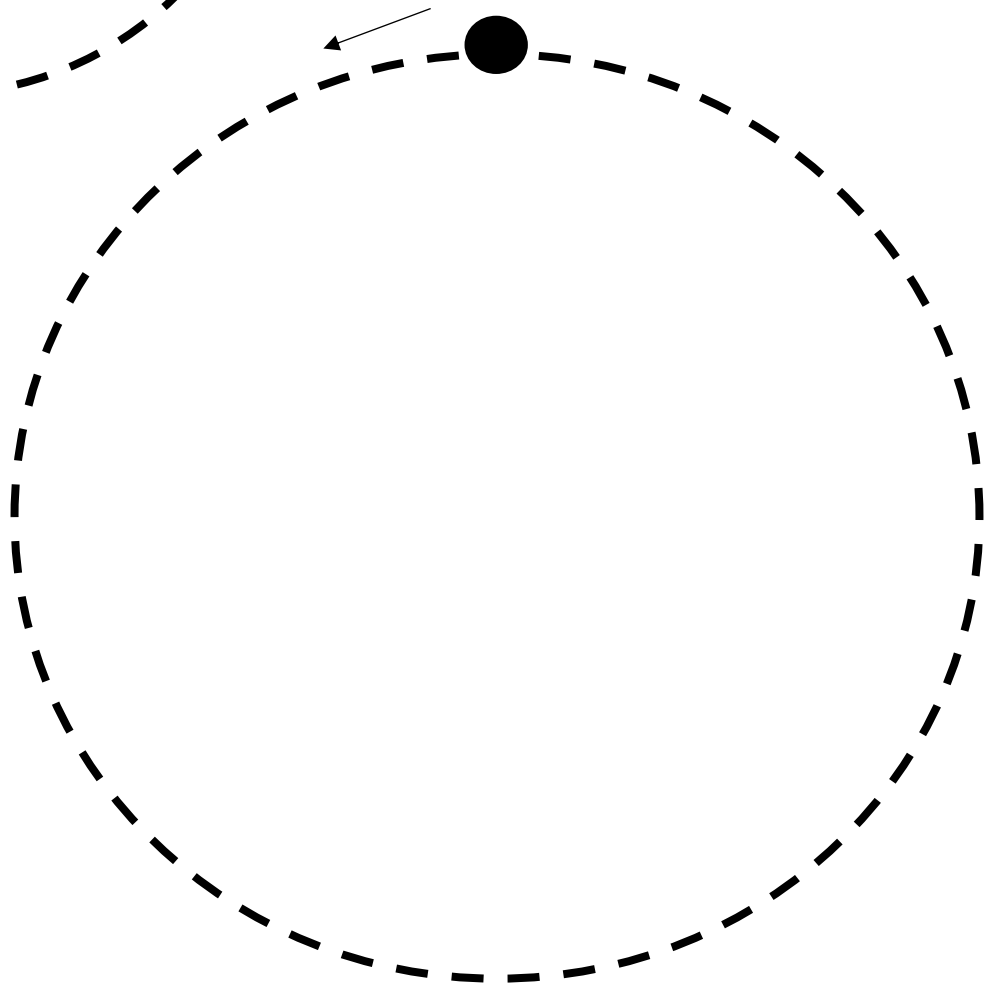
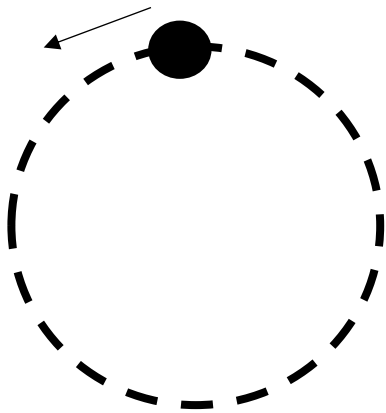
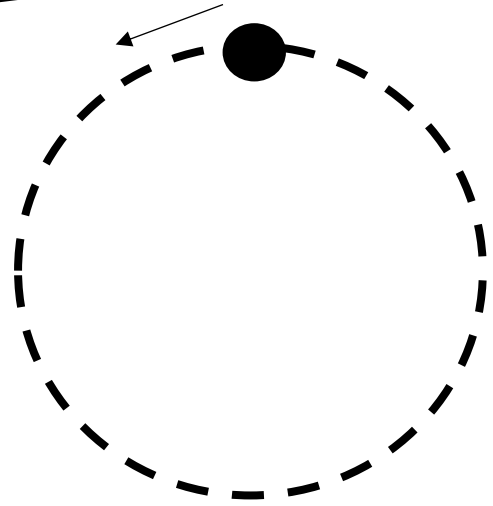
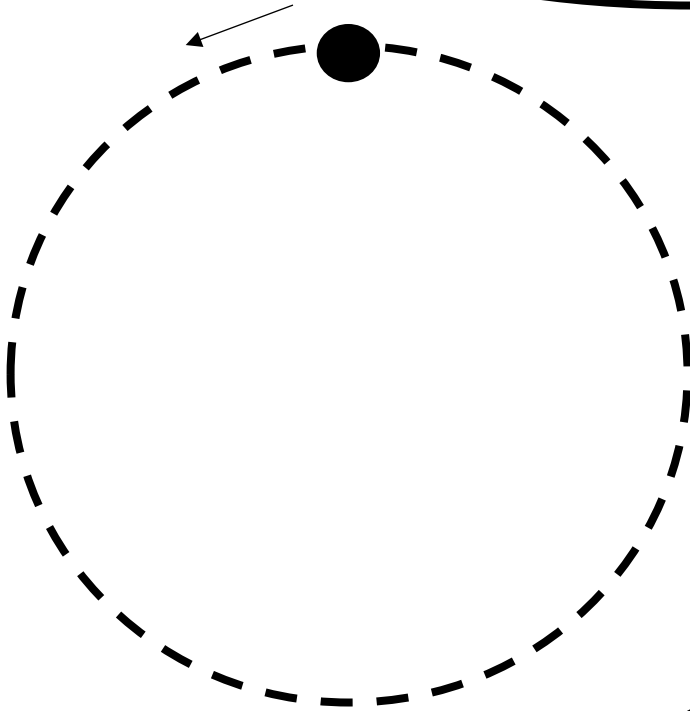
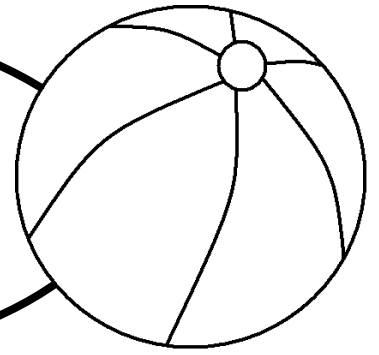

Die bytjie is baie
liefdevol. Oefen om vir
hom harte te teken.

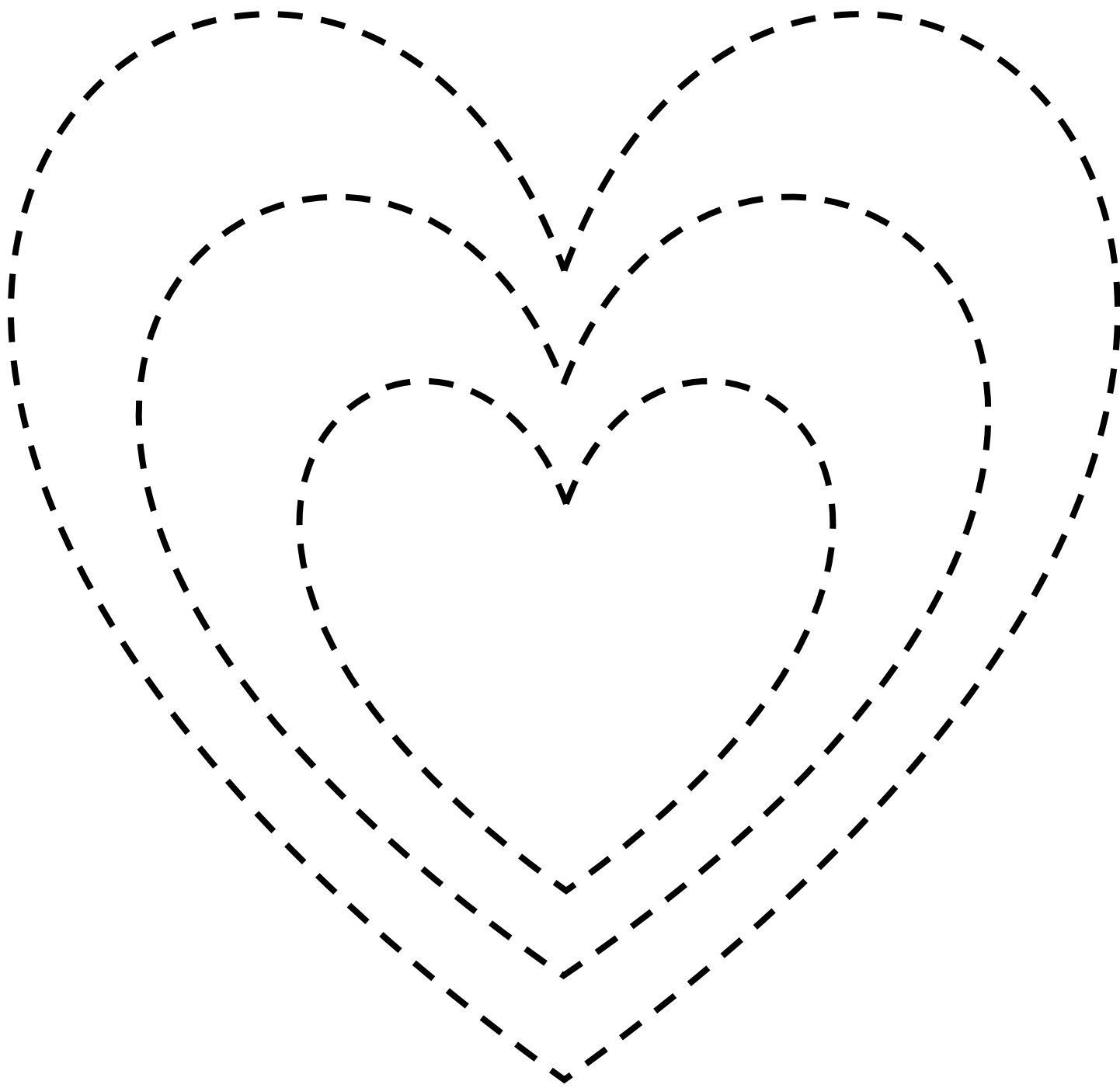
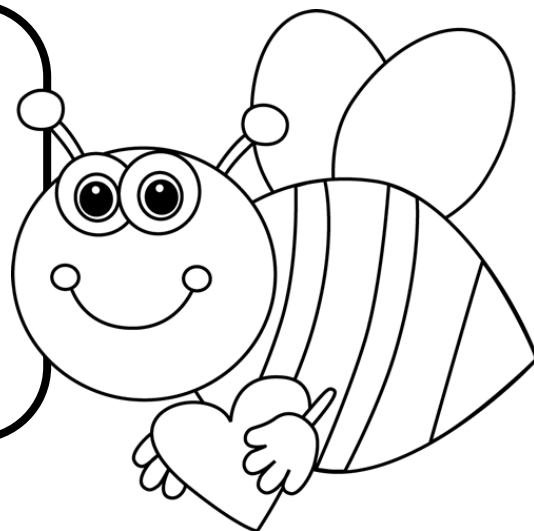

Voltooi die robot se
patrone.

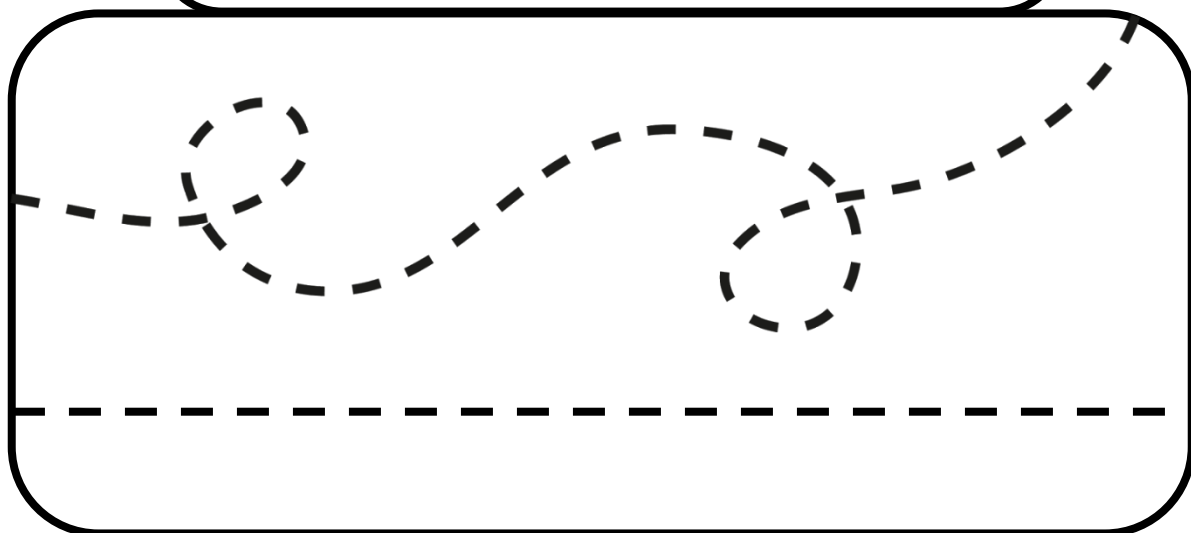
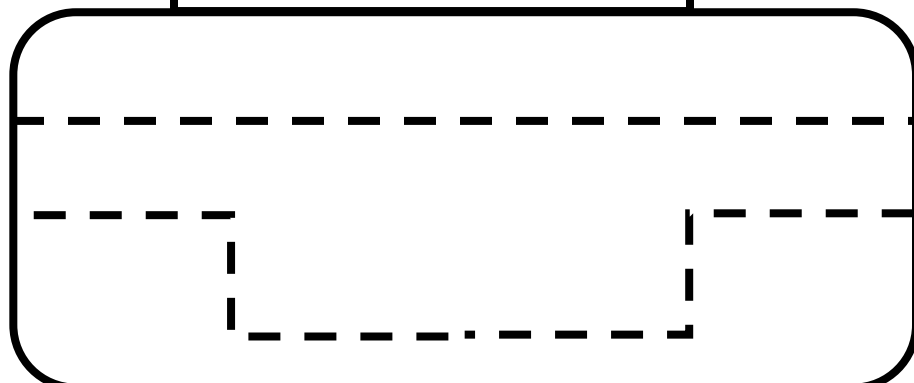
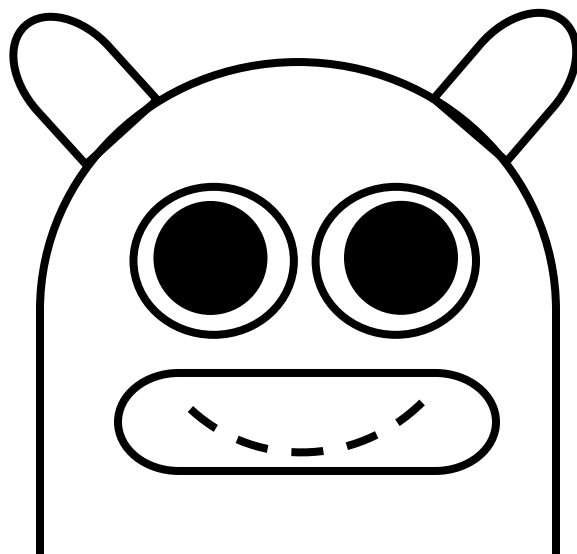

Kom ons oefen die
vierkant.

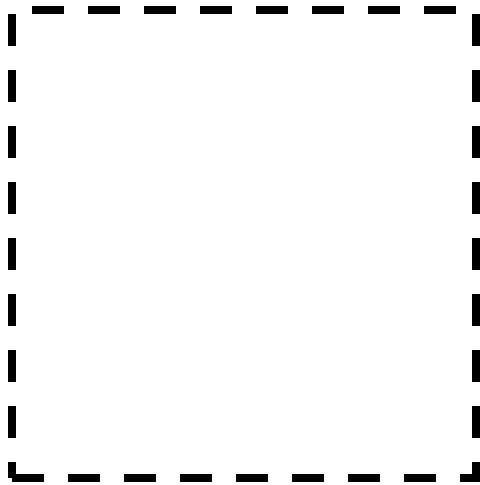
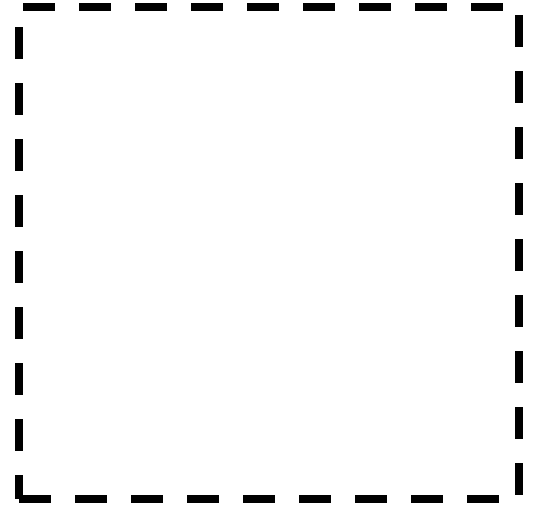
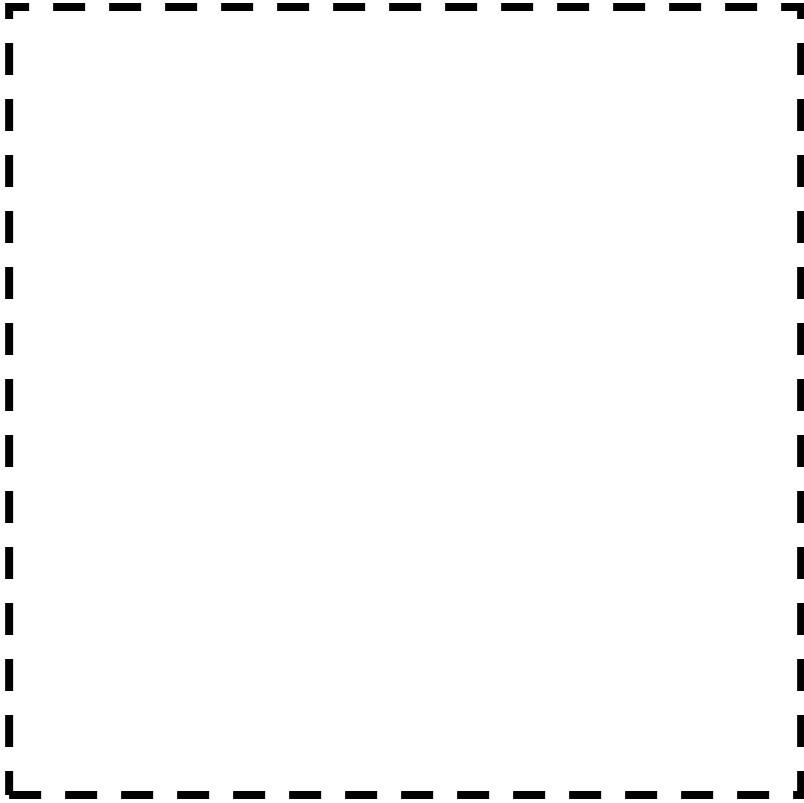
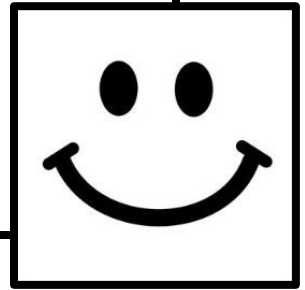

Voltooi die stippellyn
prent

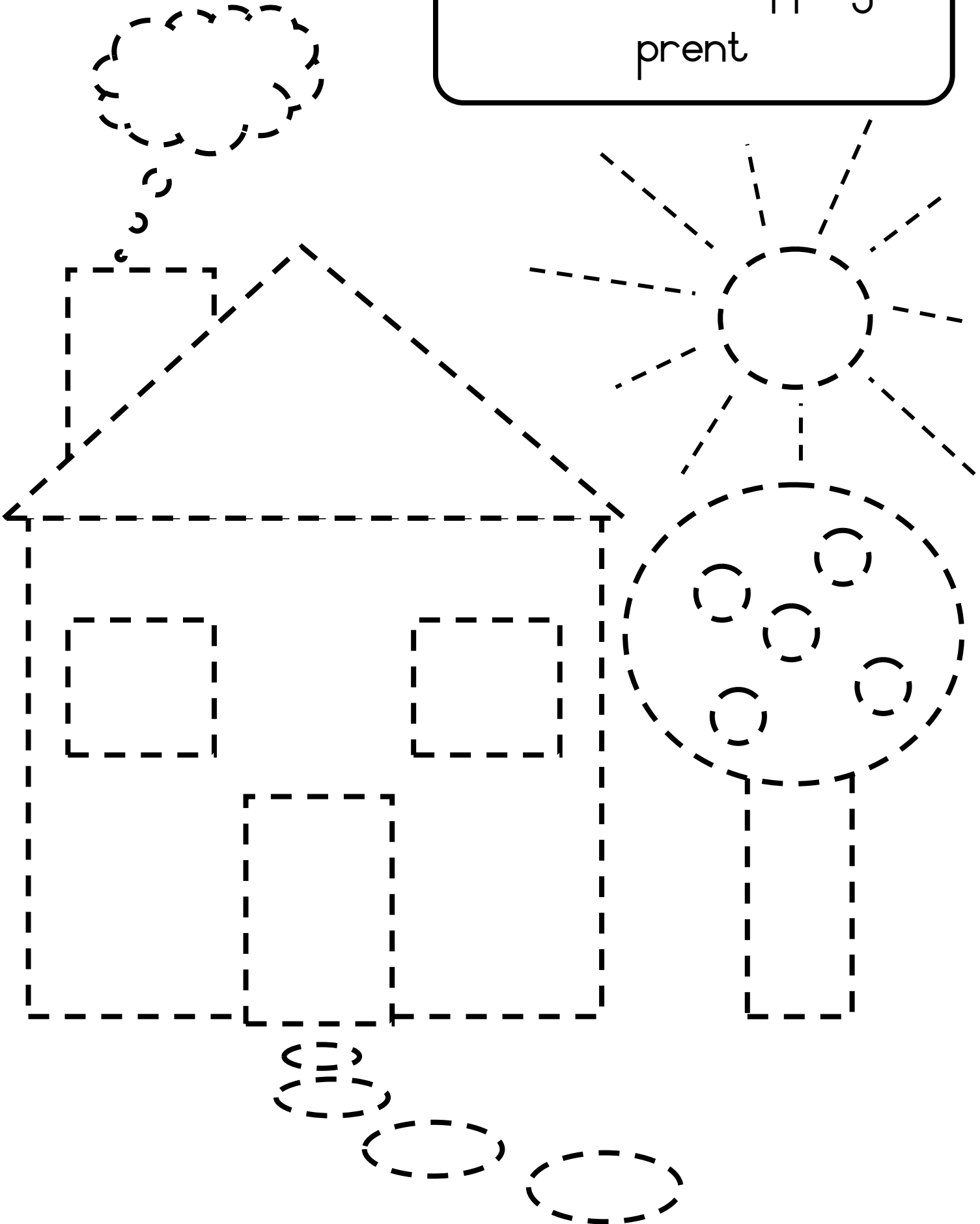

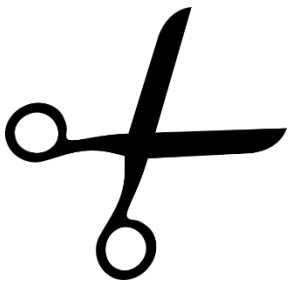

Kleur die vorms in, knip dit uit en plak dit op hul maat op die volgende bladsy

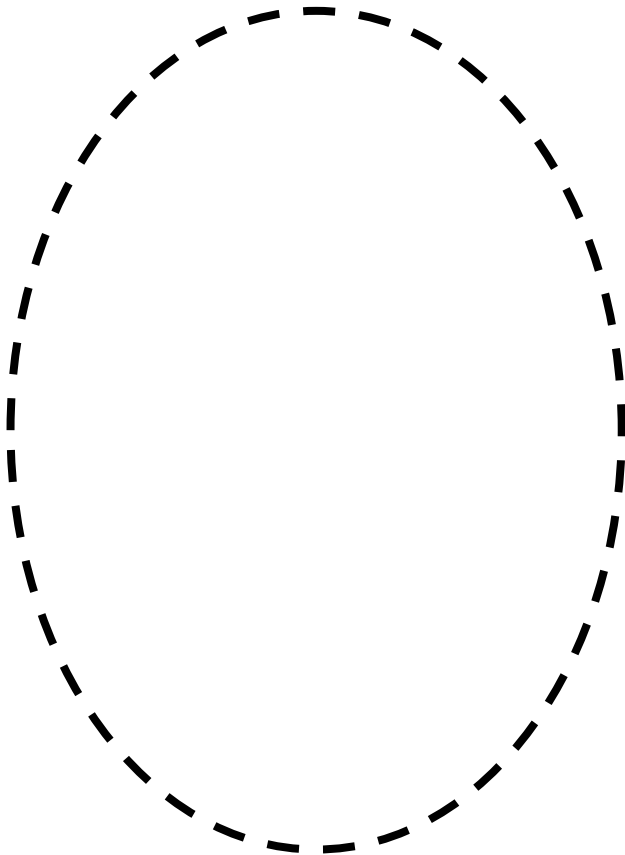
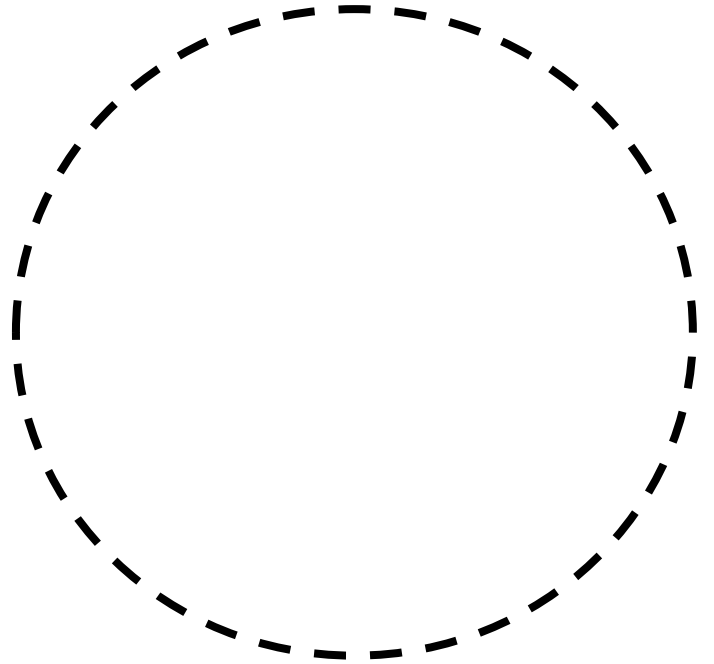
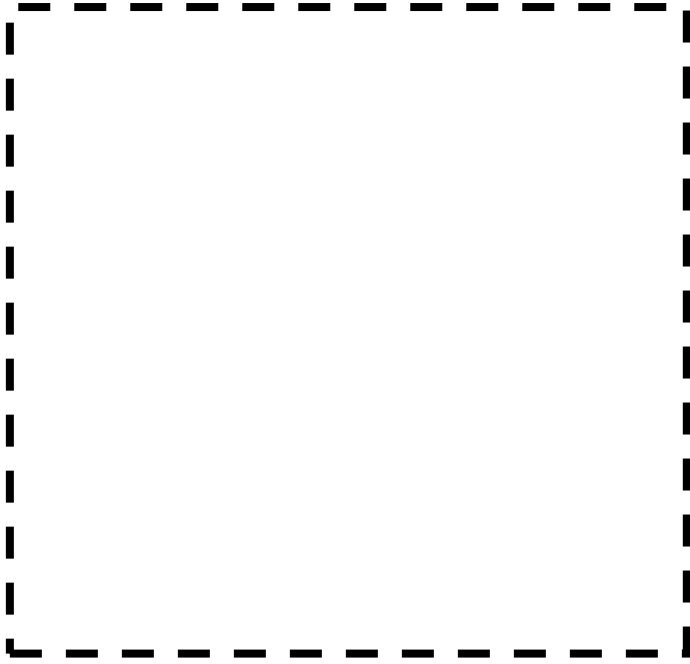

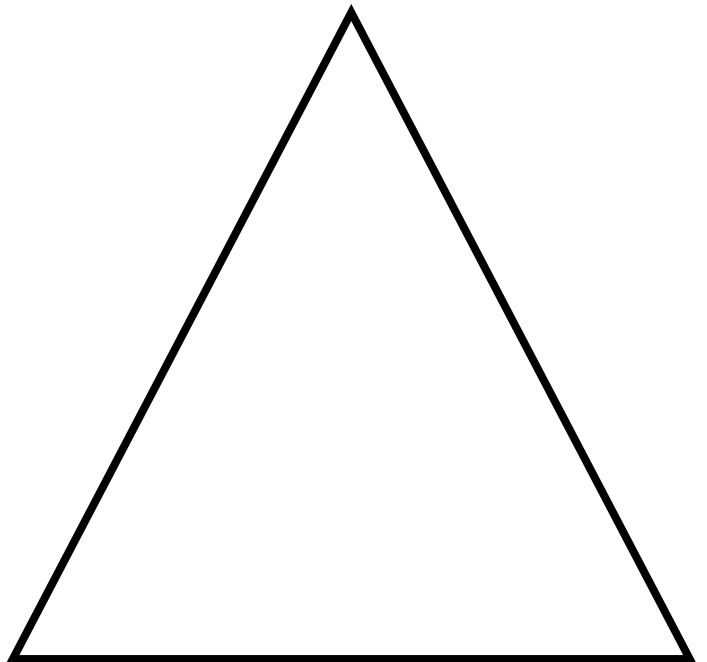
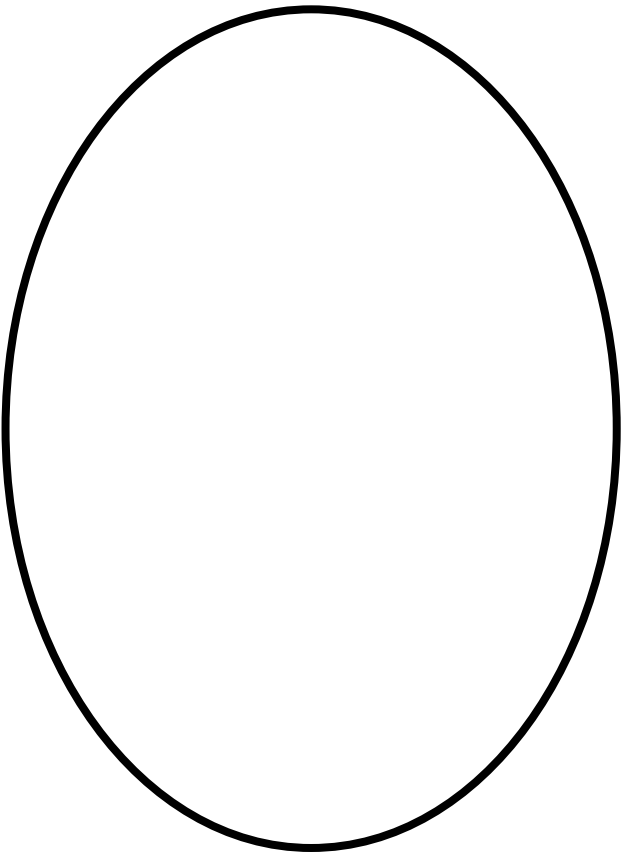
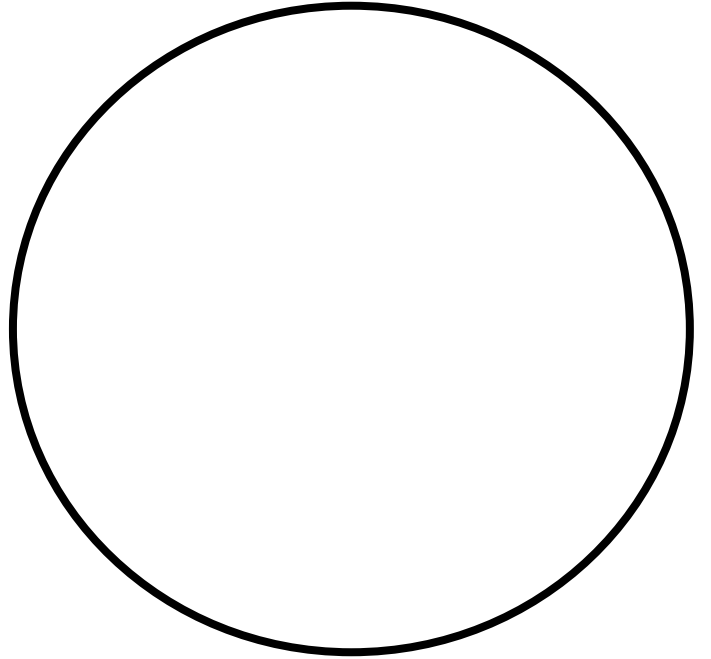

Knip rooi prente uit 'n tydskrif en
plak dit

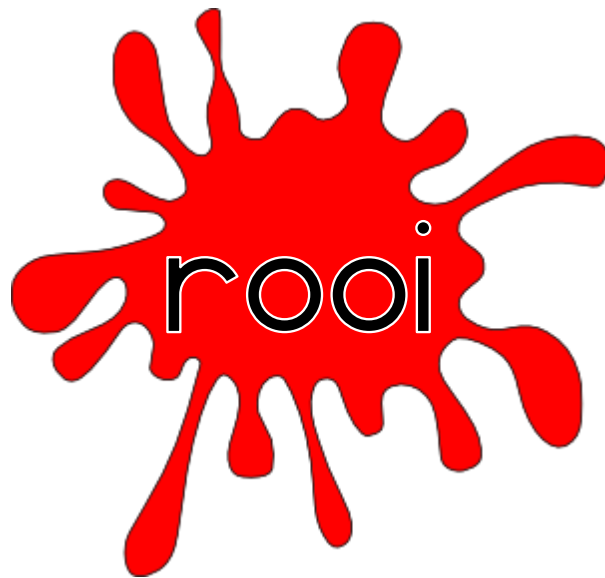

Knip blou prente uit 'n tydskrif en
plak dit

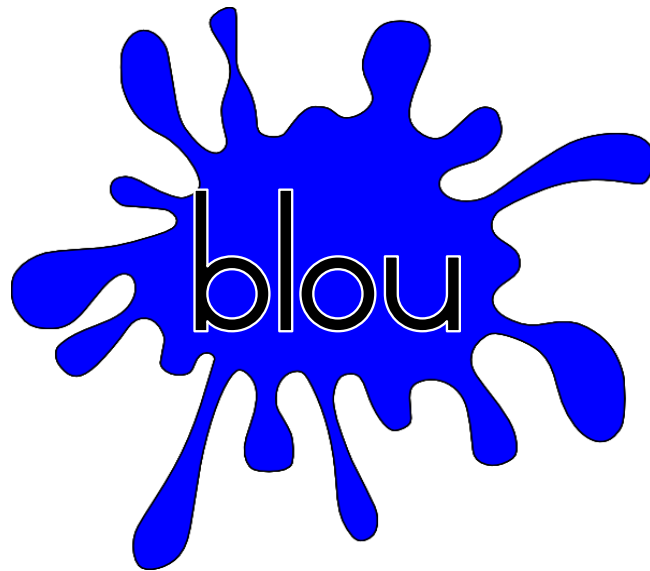

Knip pers prente uit 'n tydskrif en
plak dit

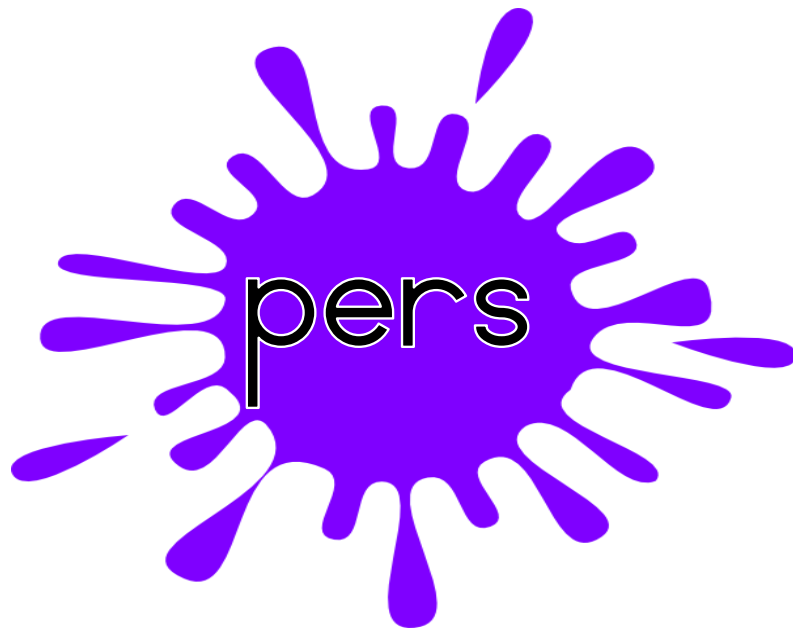

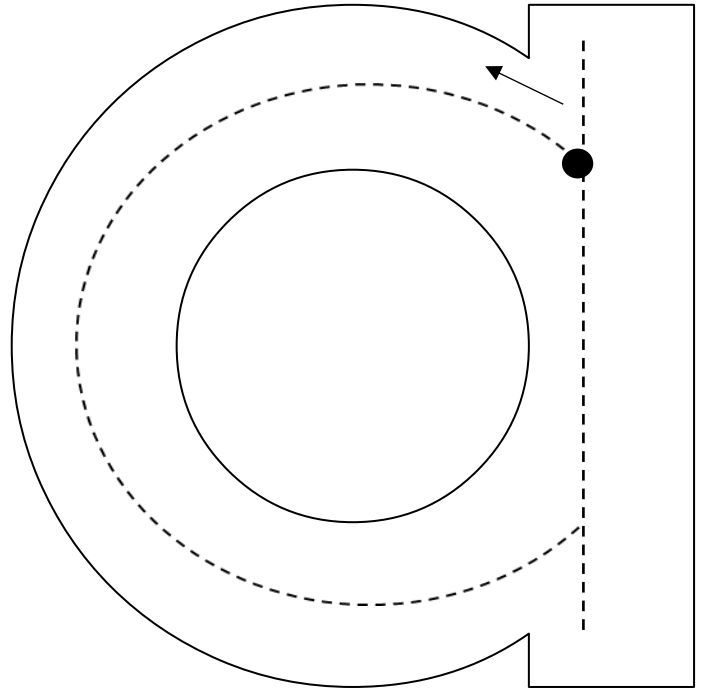
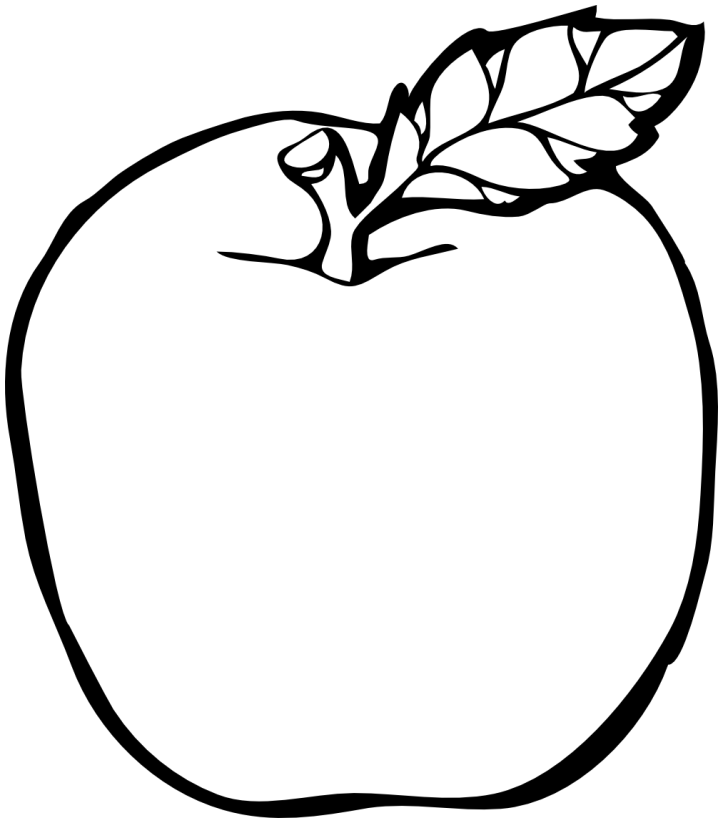

appel

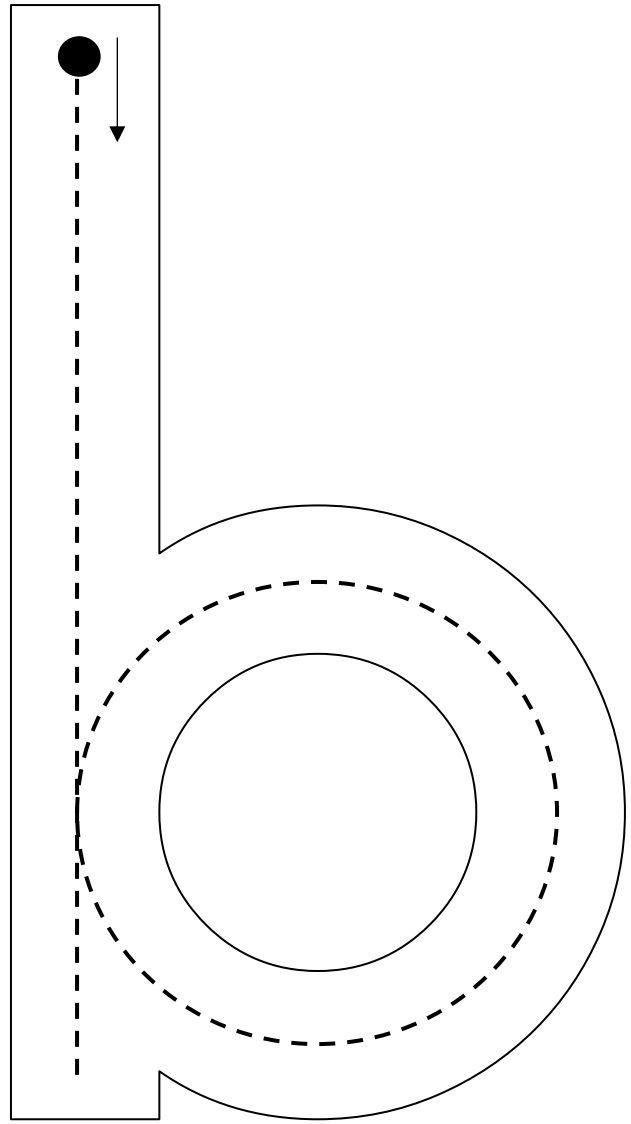

ba

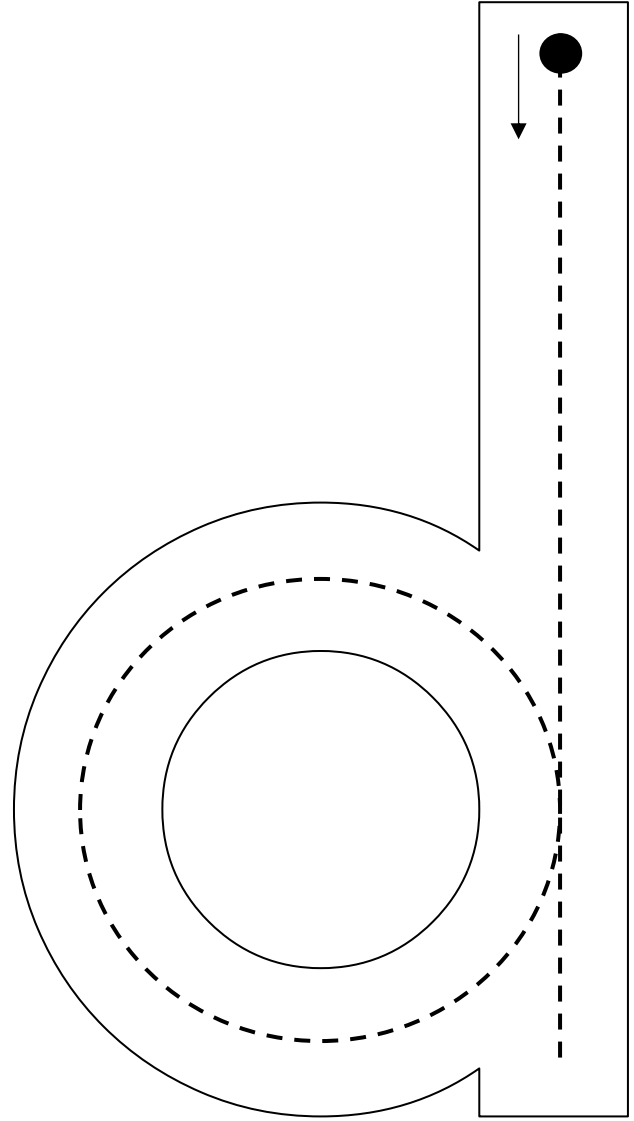
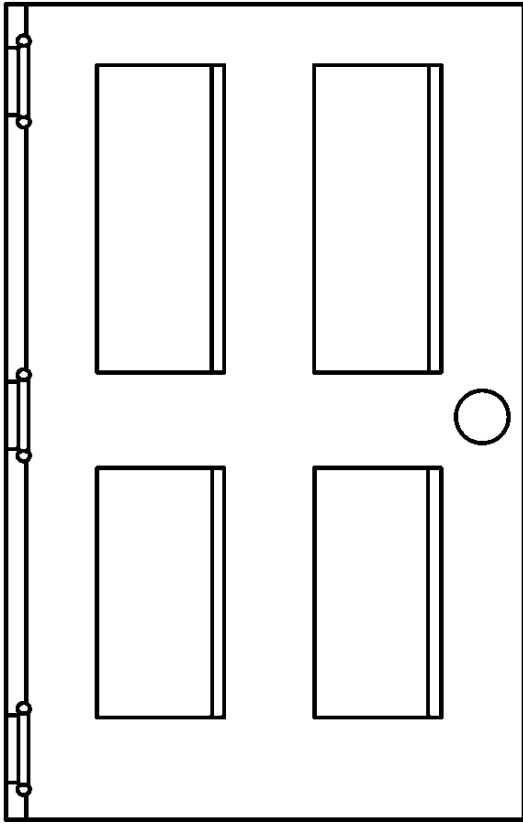

deur

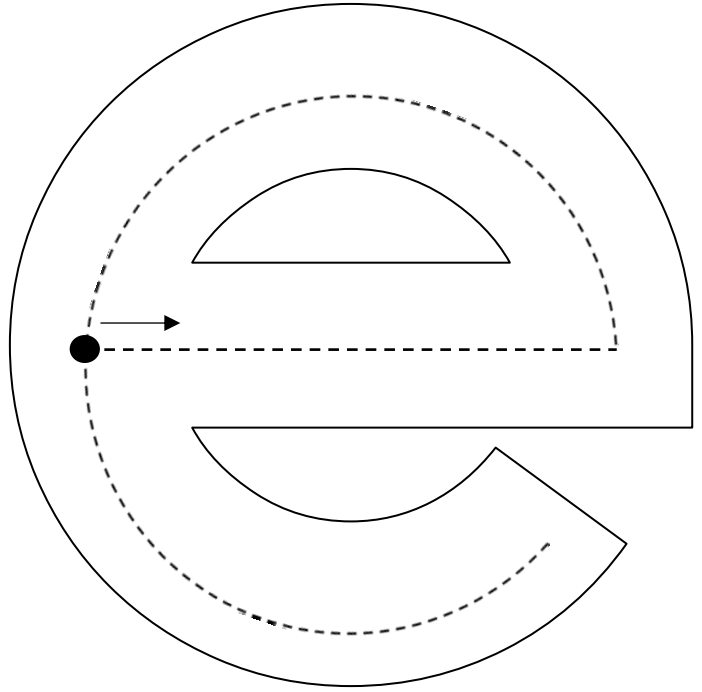
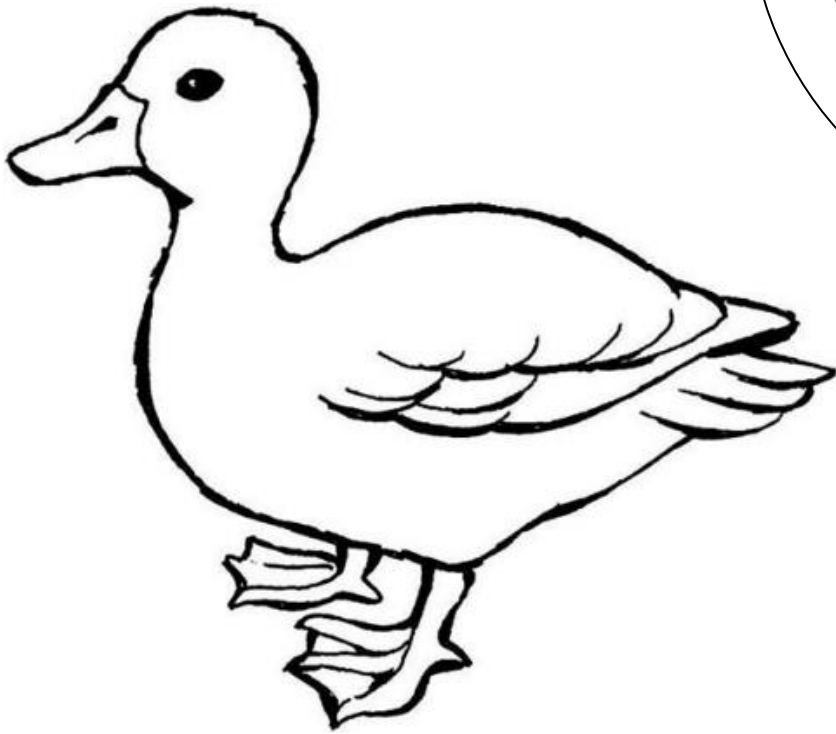

e e n d

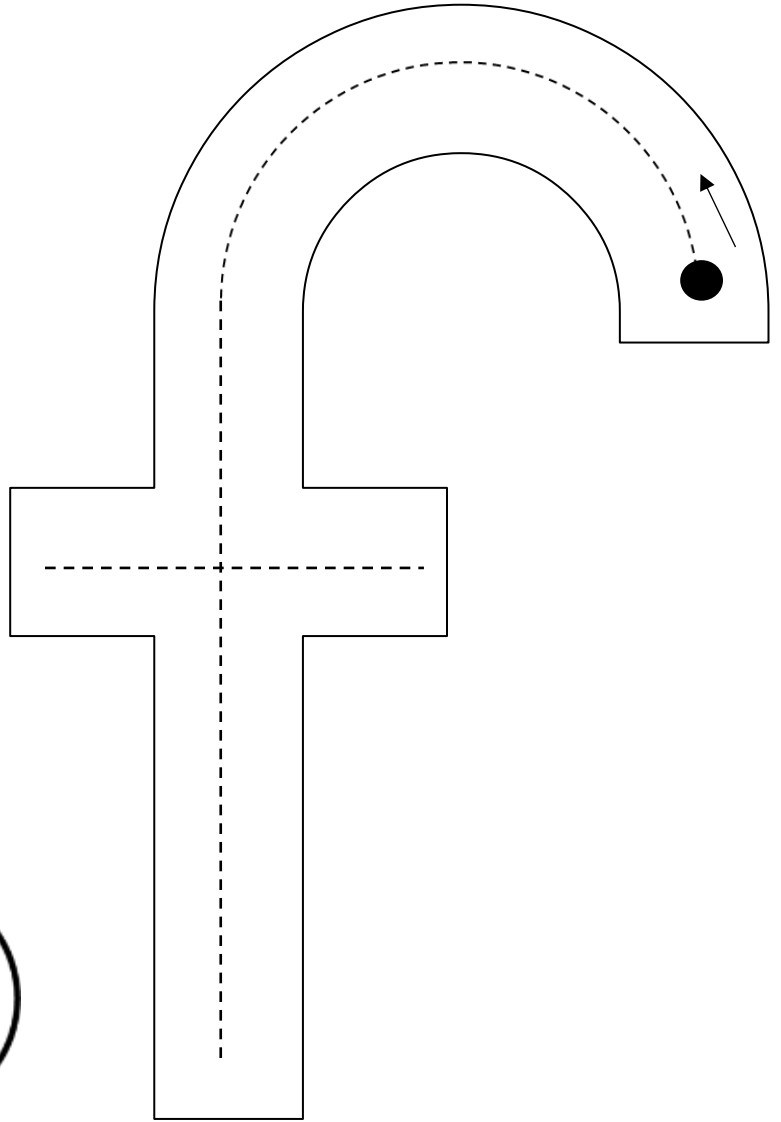

f fiets

Hoeveel appels is daar?

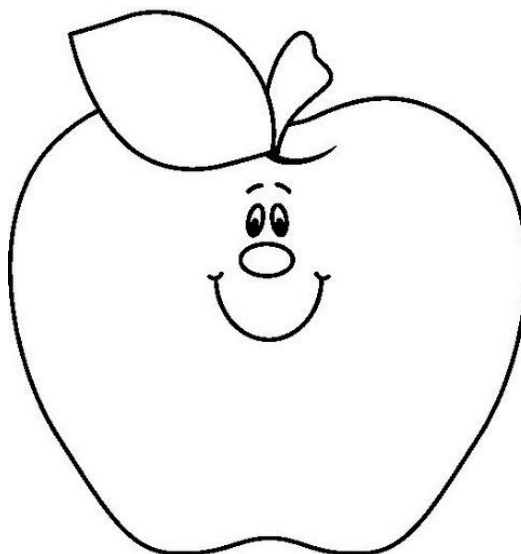
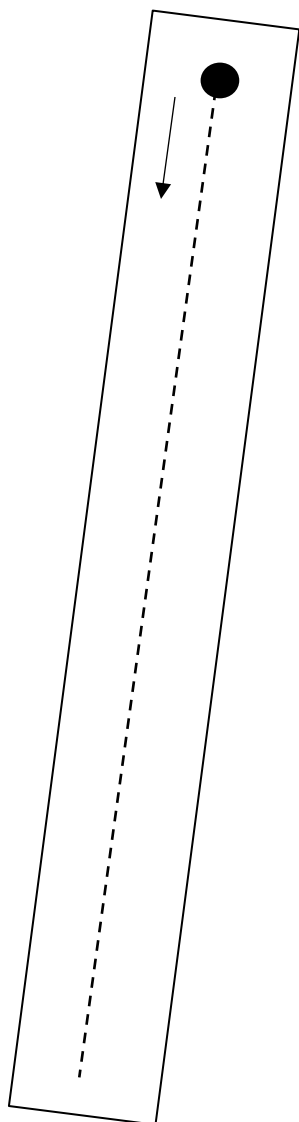

Handwriting practice area with a rounded rectangular border. It contains two sets of horizontal lines. The first set consists of a solid top line, a dashed middle line, and a solid bottom line. The word "een" is written in a dotted font across the middle line. The second set consists of a solid top line, a dashed middle line, and a solid bottom line. The number "1" is written in a dotted font across the middle line, and there are four more blank dotted "1"s for practice.

Hoeveel appels is daar?

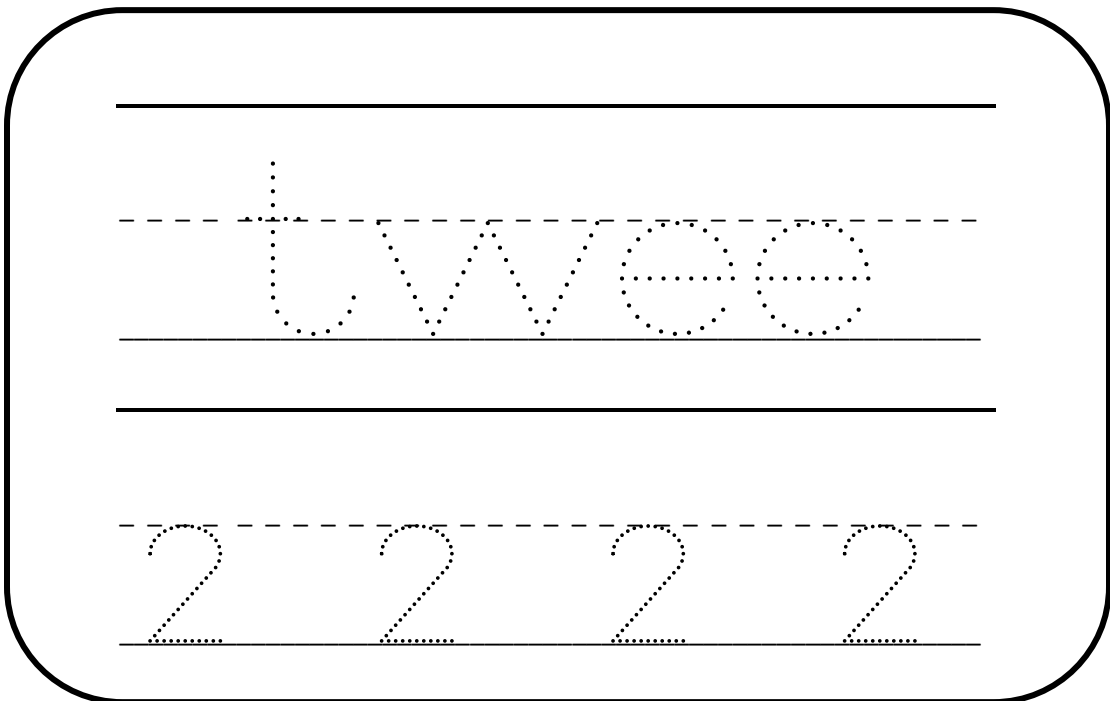
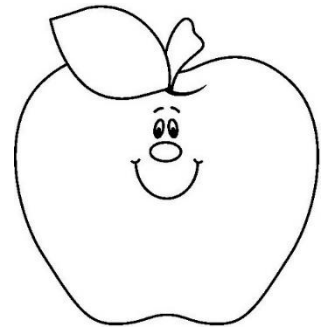
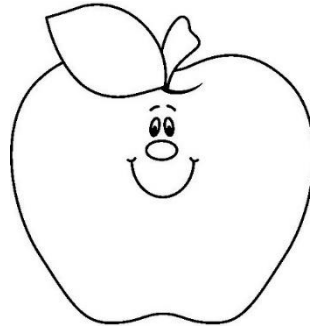
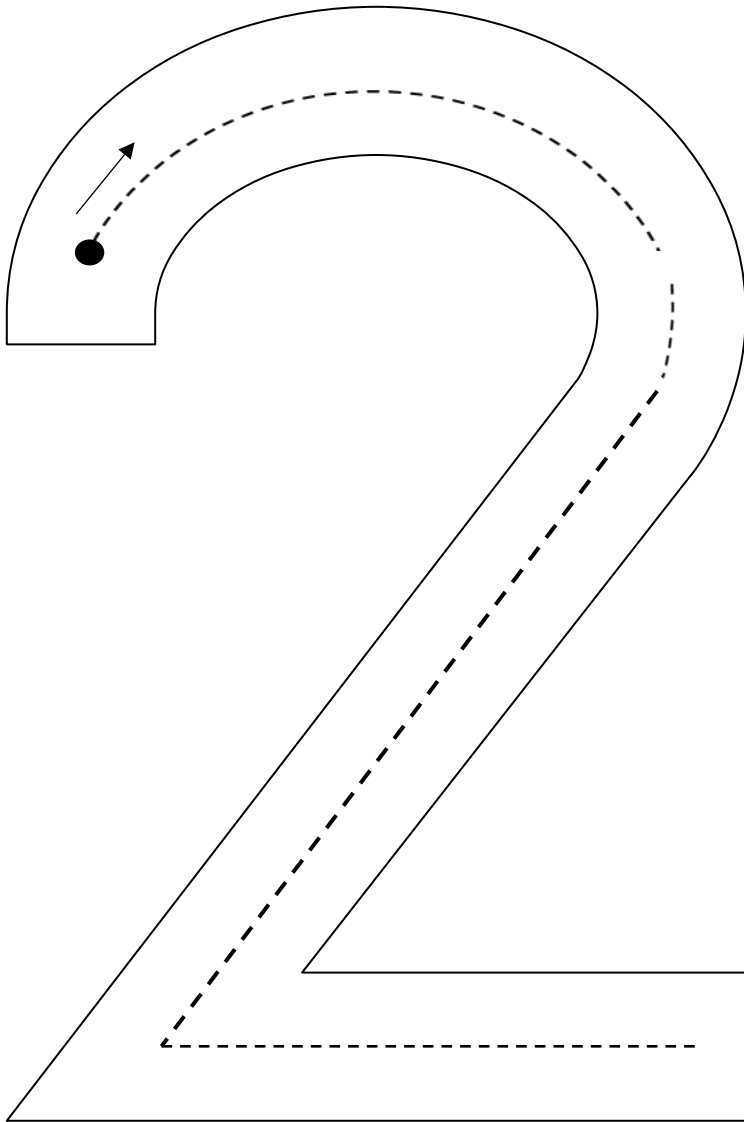

Hoeveel appels is daar?

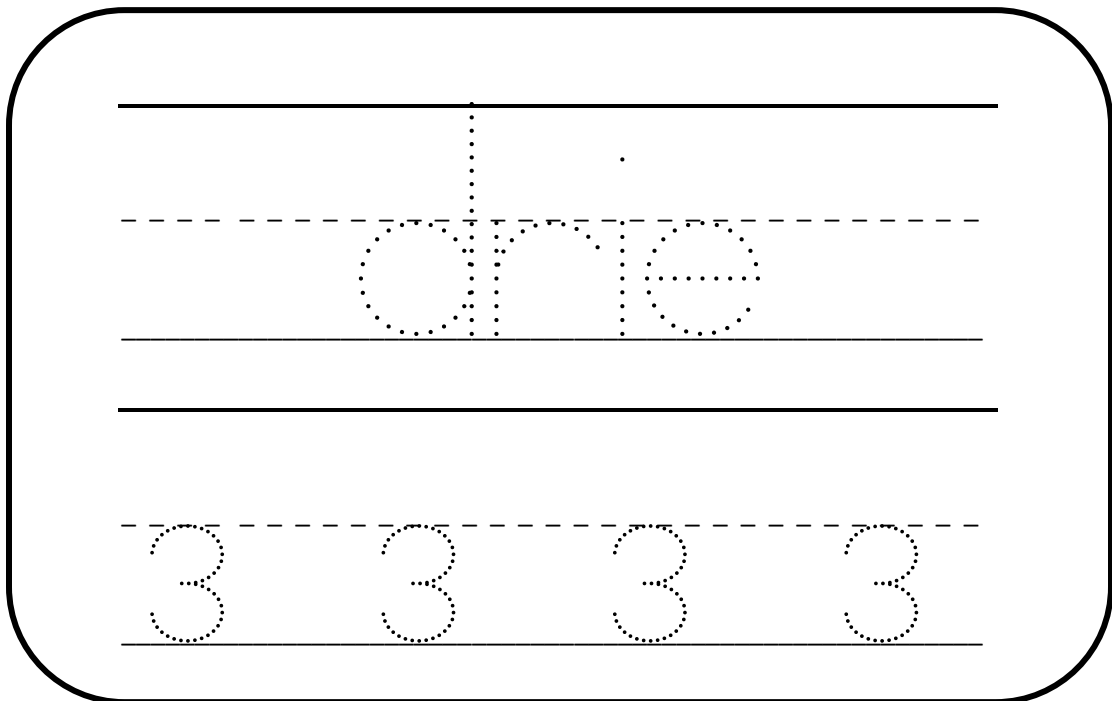
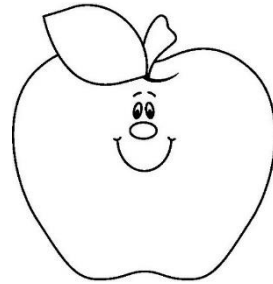
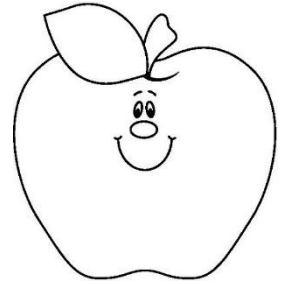
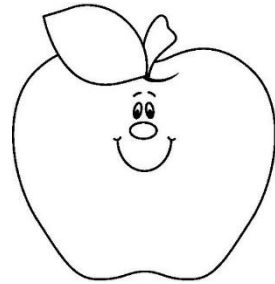
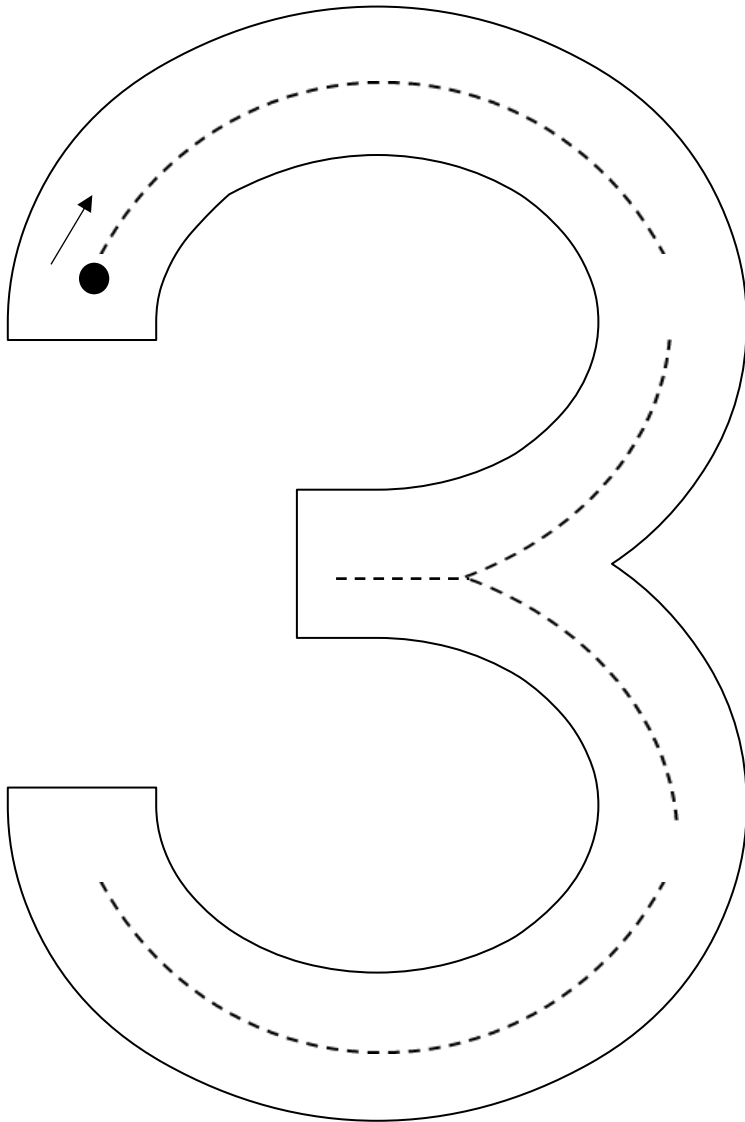

Hoeveel appels is daar?

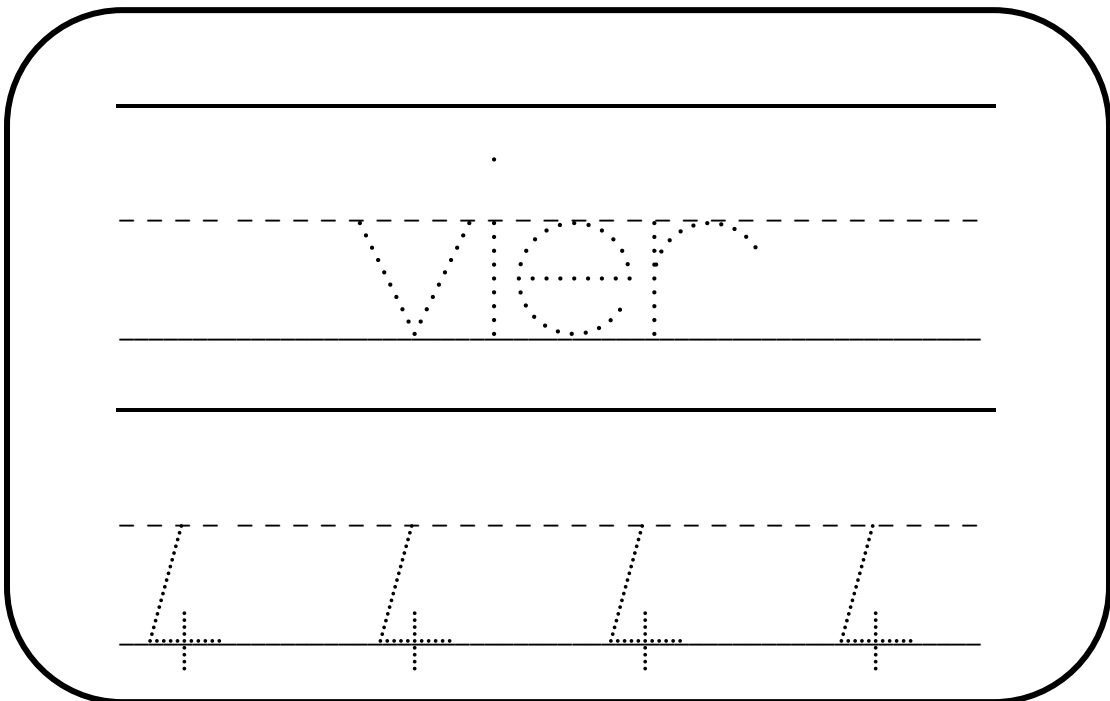
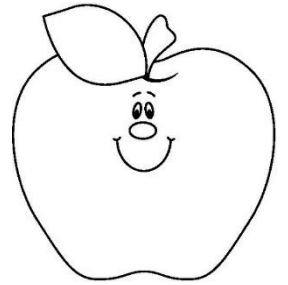
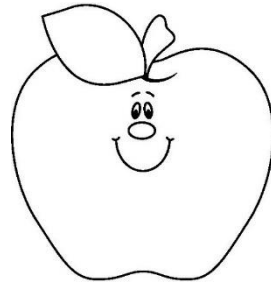
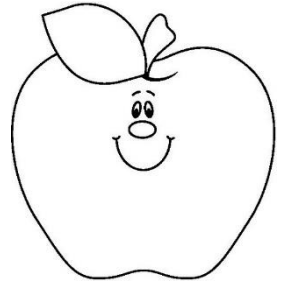
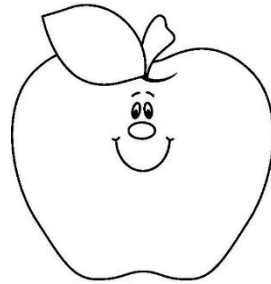
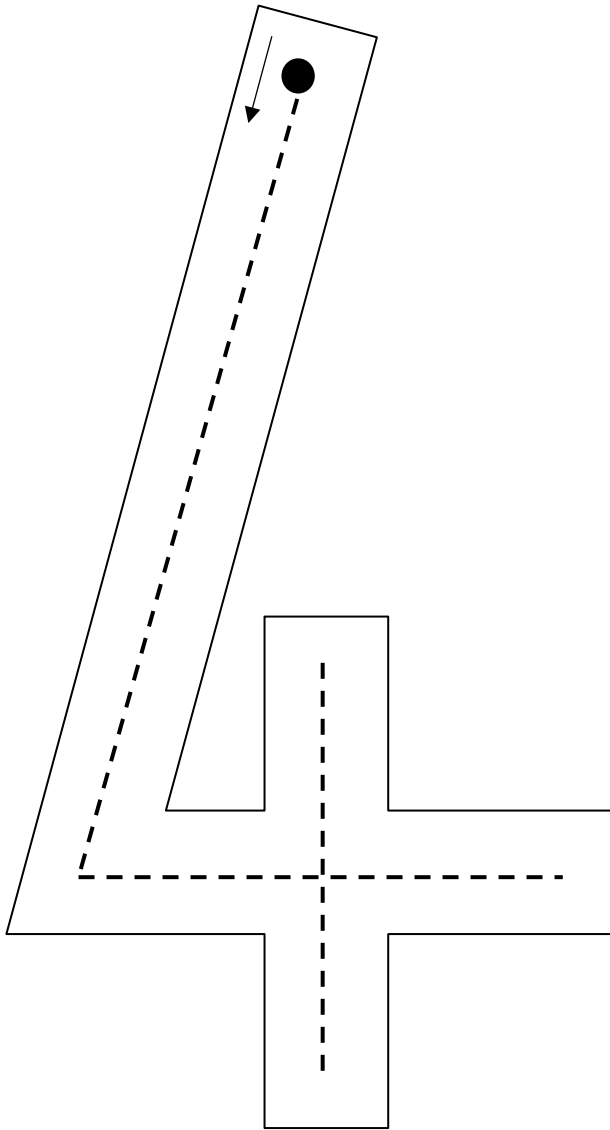

Hoeveel appels is daar?

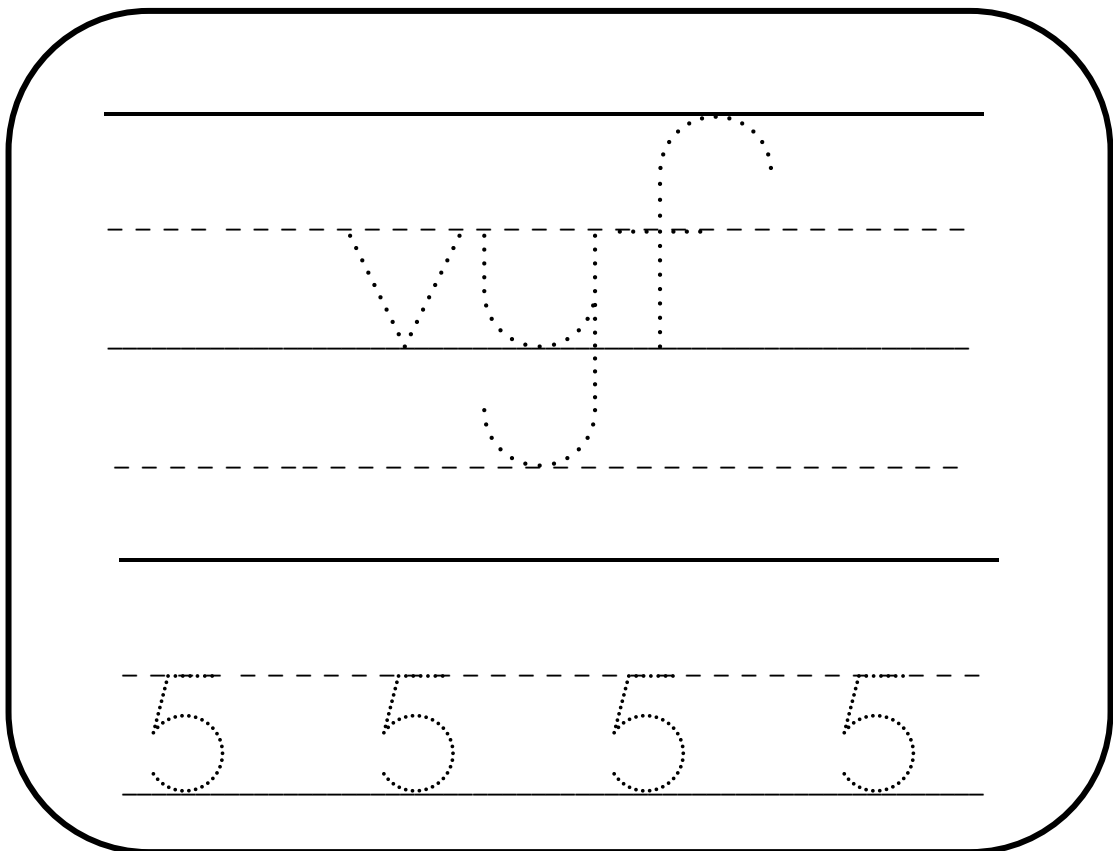
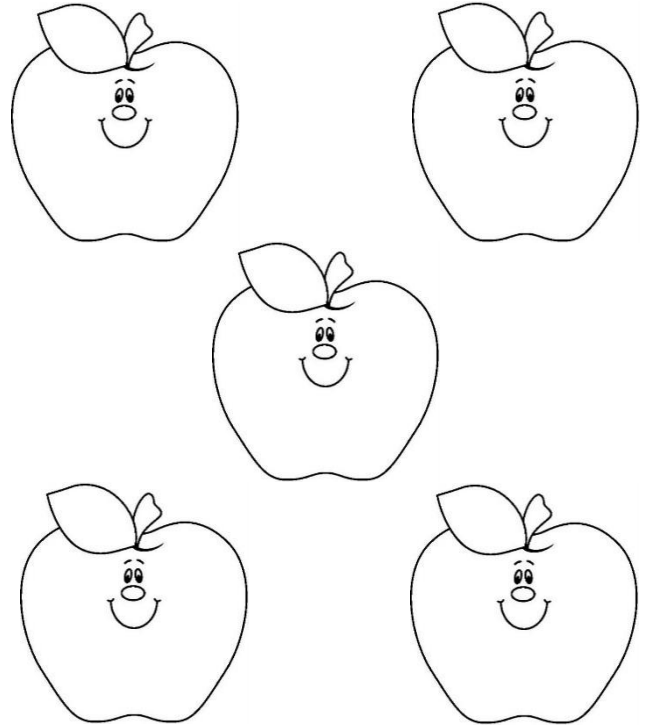
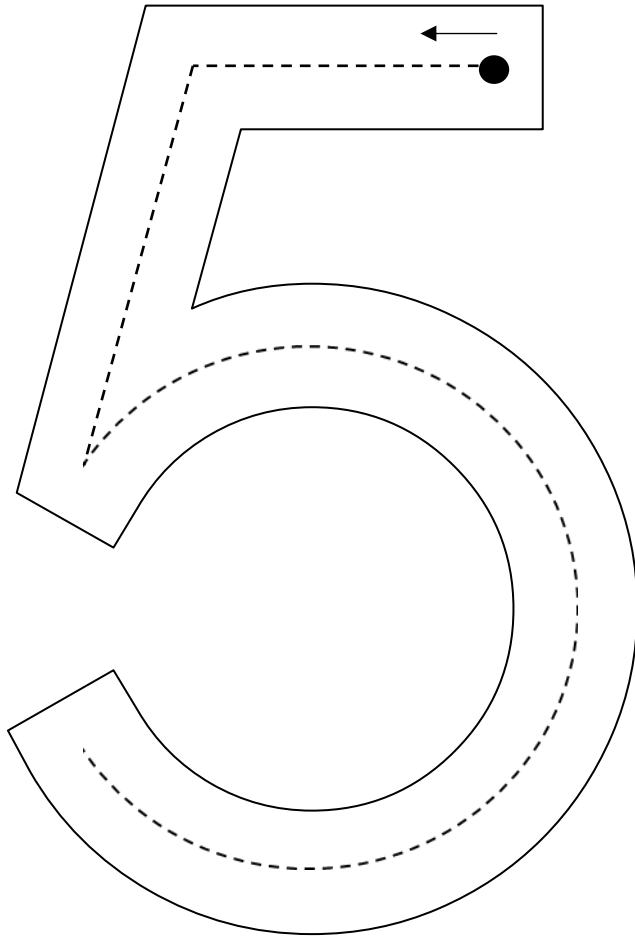

Ek ken my kleure!

Kleur die prent die regte kleur in
en oefen die woord

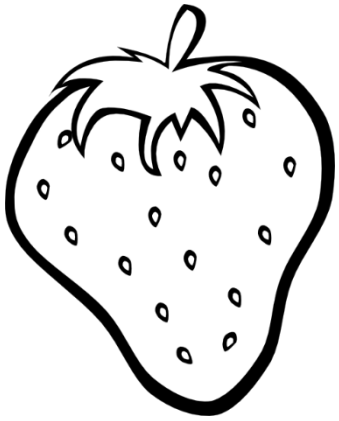

rooi

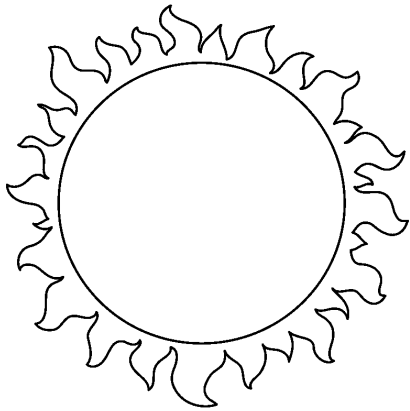

geel

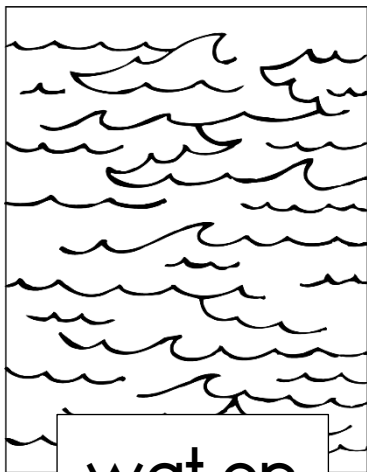

water

blou

Die blaar is

groen

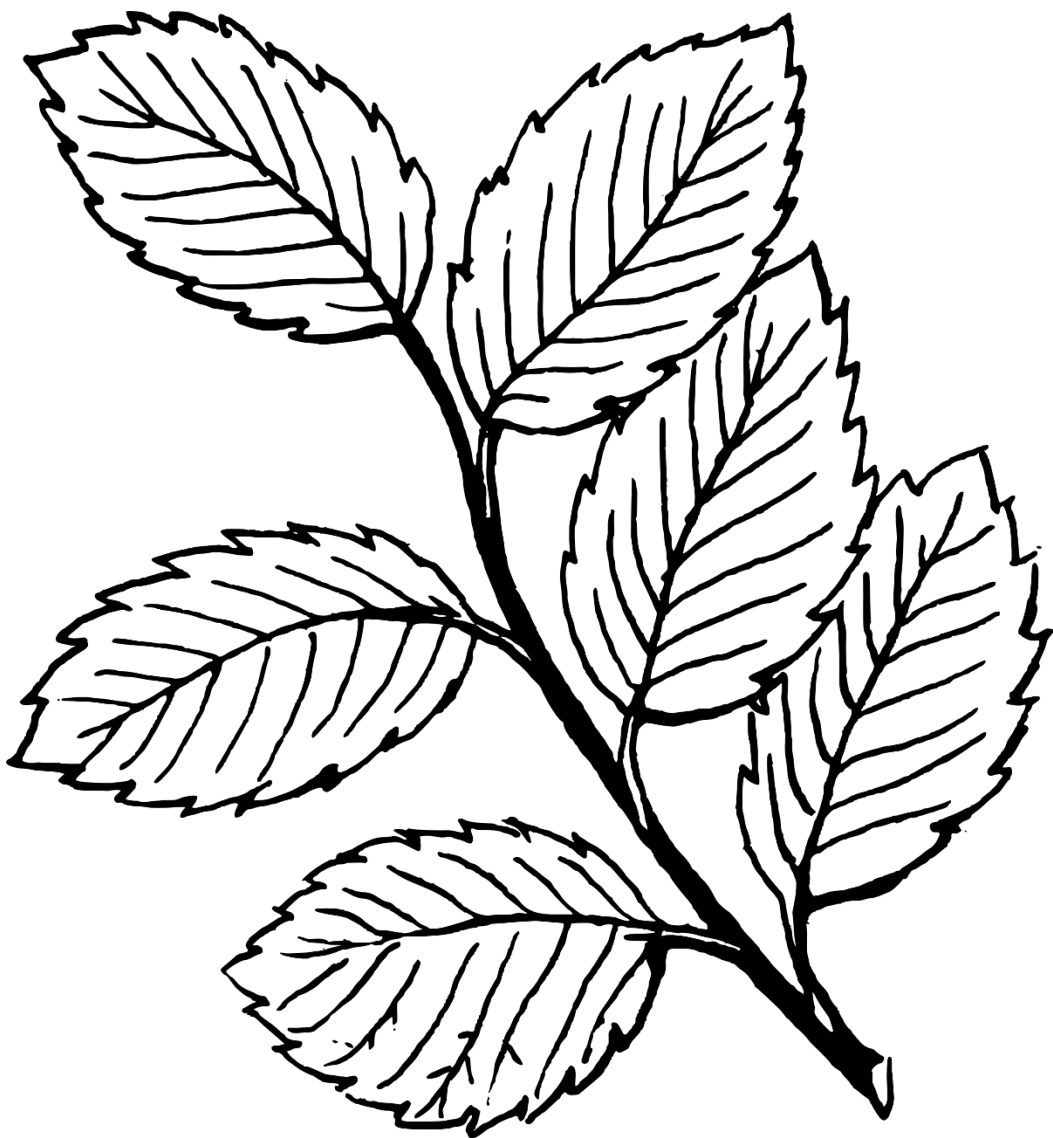

Die lemoen

is oranje

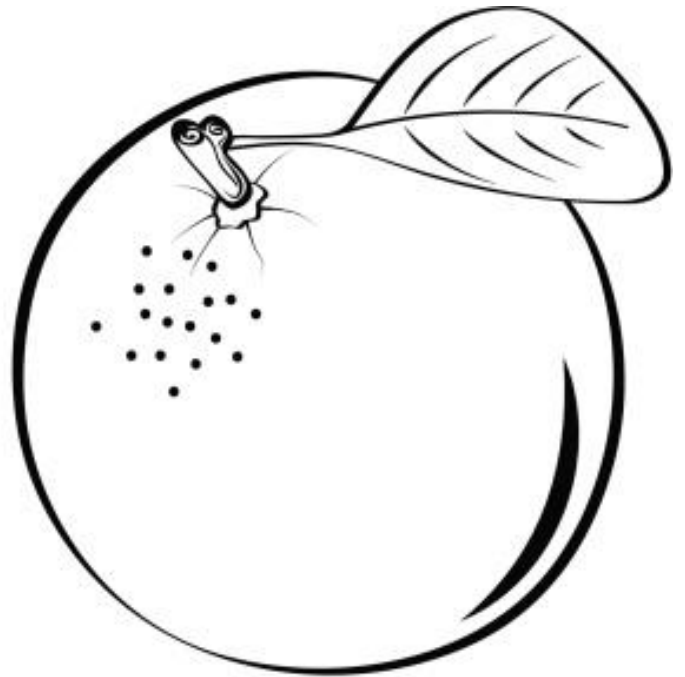
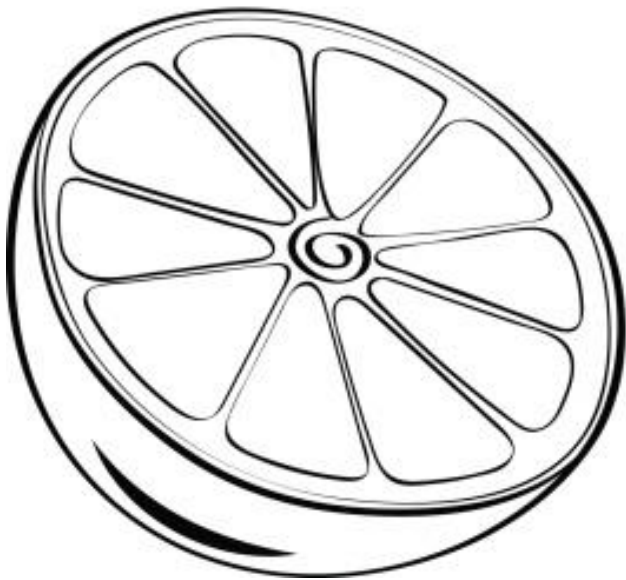

A decorative border of black circles surrounds the text. The circles are arranged in a rectangular pattern, with seven circles on each of the top and bottom edges, and eight circles on each of the left and right edges.





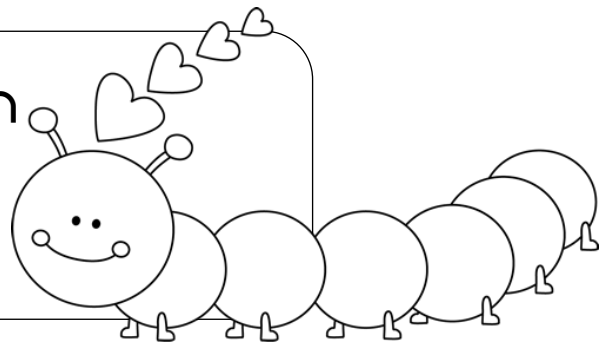

VINGERVERF

Die volgende aktiviteite is
vingerverf.

Die leerder moet die punt
van hul vinger in die verf
druk en dan die oefeninge
doen

Maak vir die wurmpie 'n
lyfie



4		
1		
3		
5		
2		
6		

Gee vir die blomme
blaartjies.

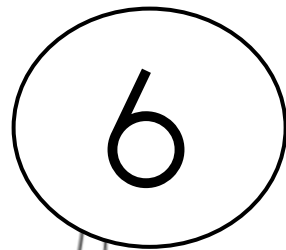
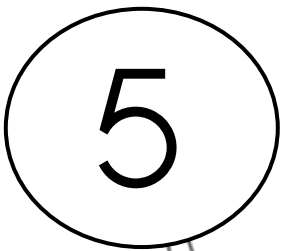
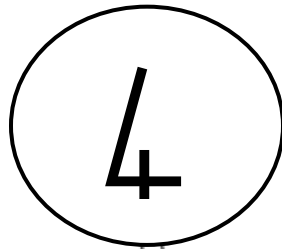

Druk met jou vinger in elke
sirkel om die letter te vorm

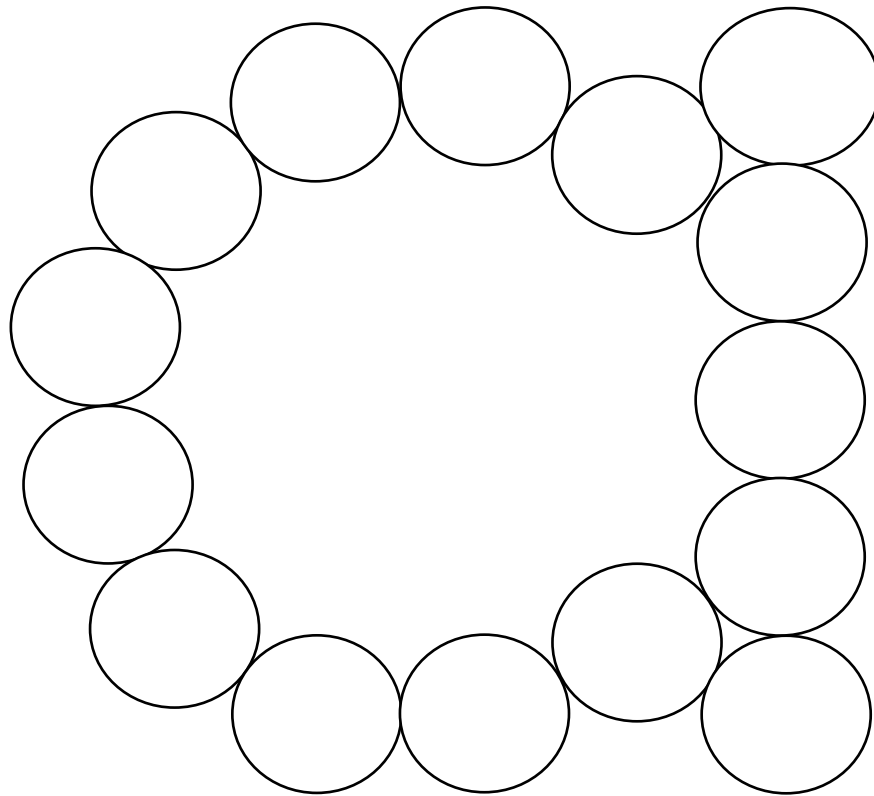

a vir

appel

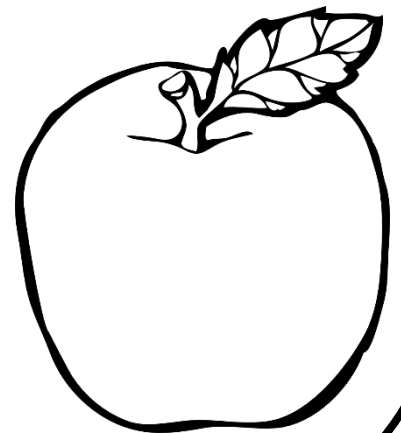

Druk met jou vinger in elke
sirkel om die letter te vorm

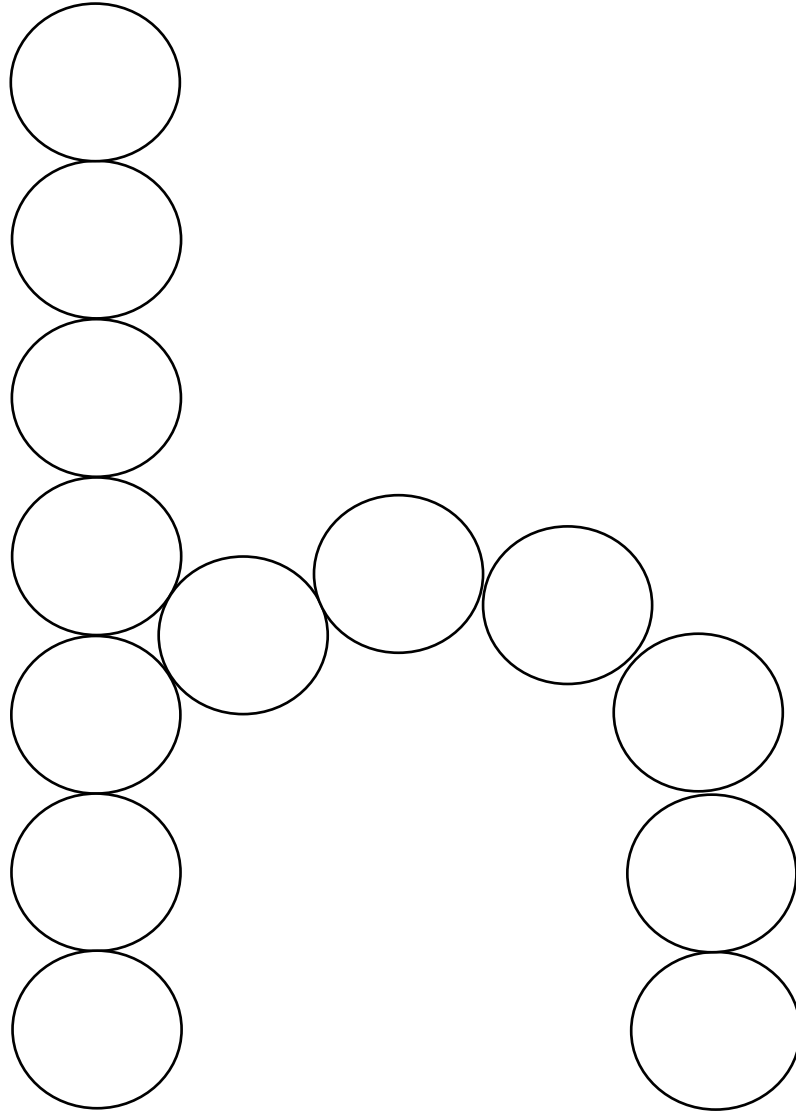

h vir

hads



Druk met jou vinger in elke
sirkel om die letter te vorm

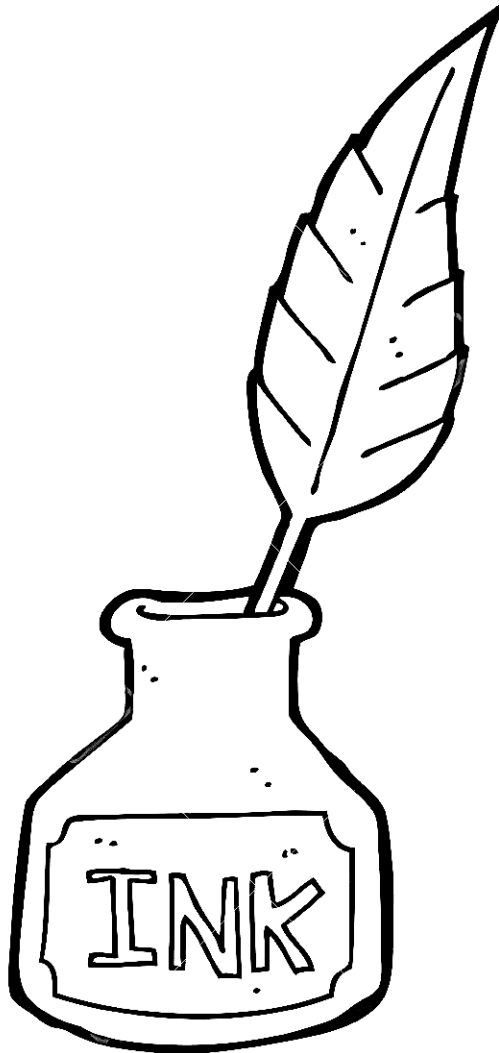
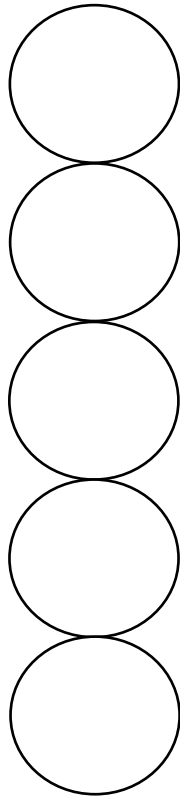
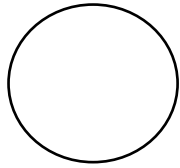

i vir

ink

Druk met jou vinger in elke
sirkel om die letter te vorm

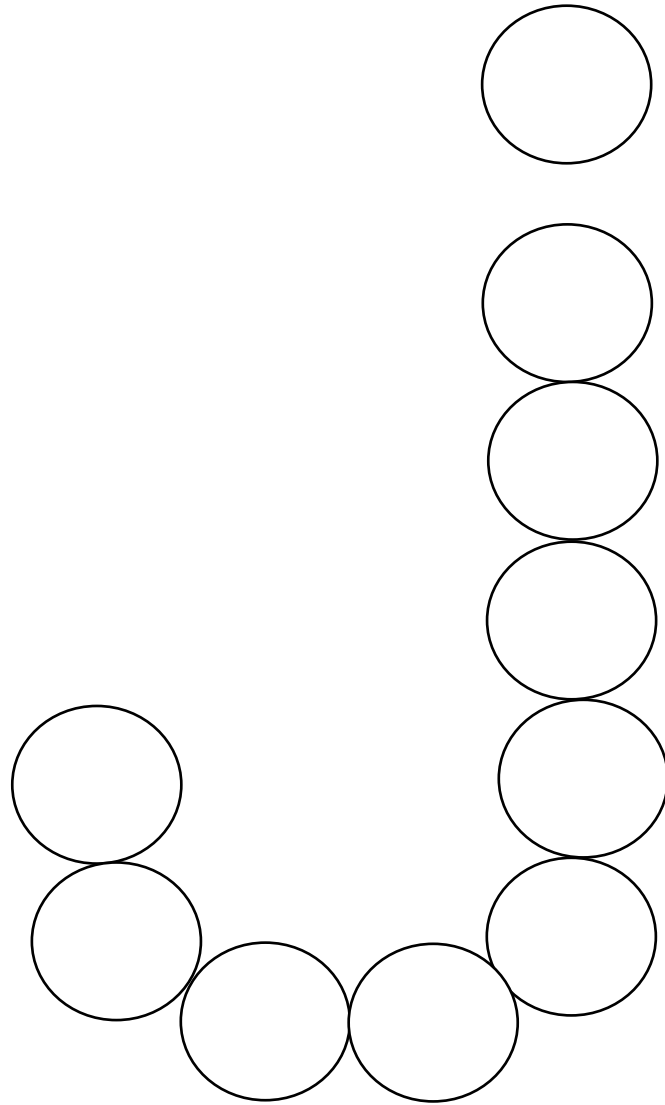

j vir

jas

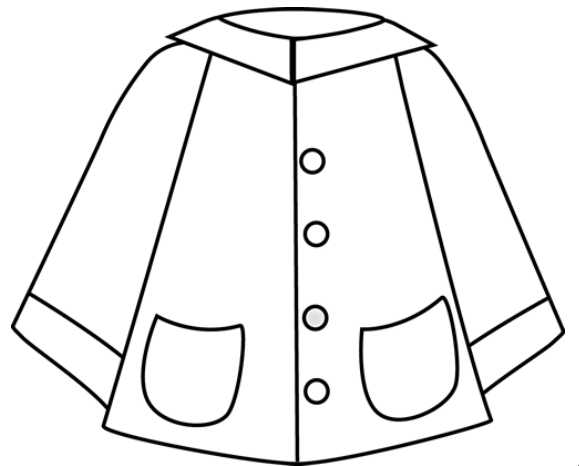

Druk met jou vinger in elke
sirkel om die letter te vorm

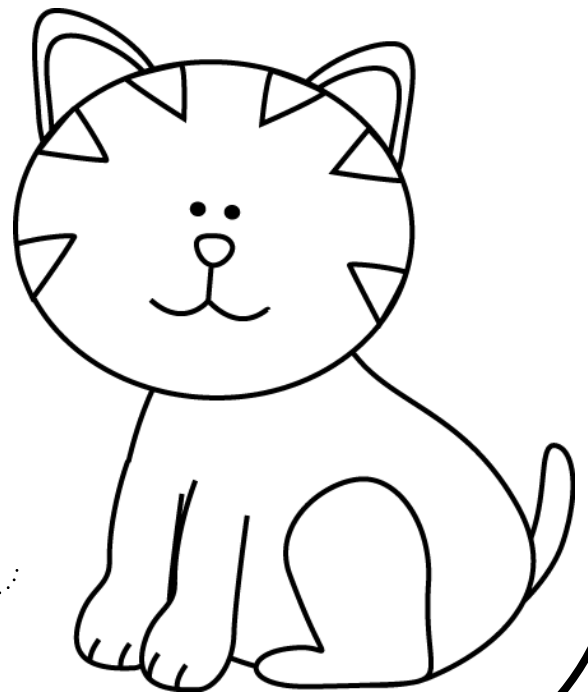
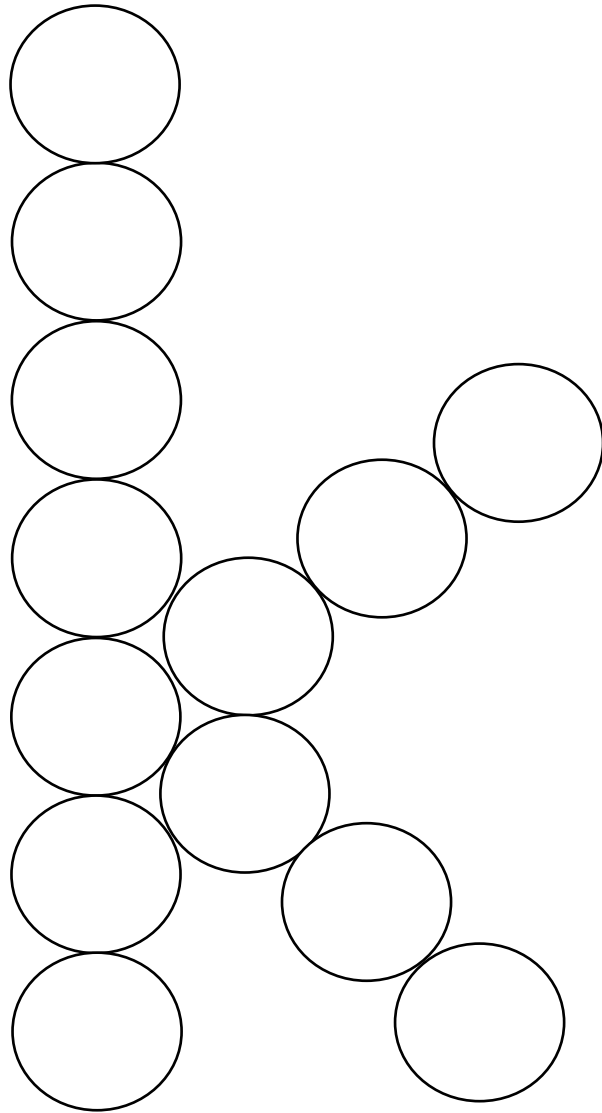

k vir

kat

Druk met jou vinger in elke
sirkel om die letter te vorm

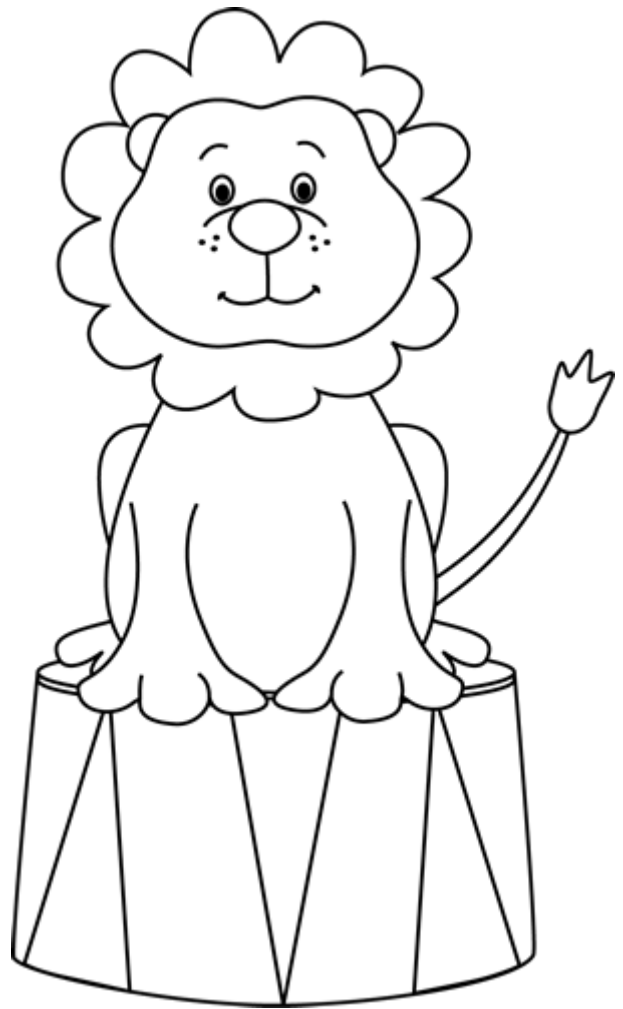
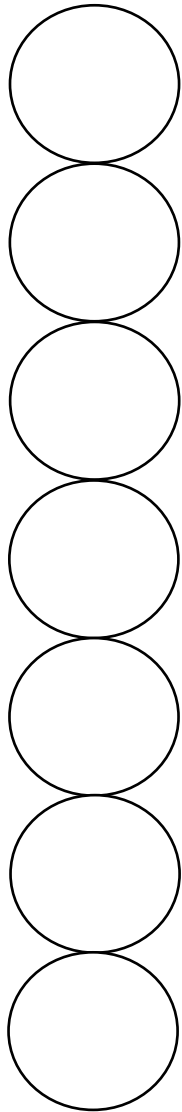

I vir

leou