

GRAAD 1

AFRIKAANS HUISTAAL

Kwartaal 1

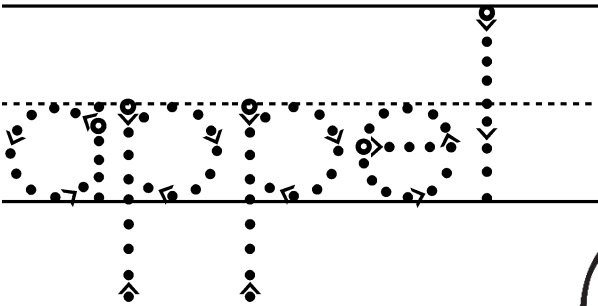
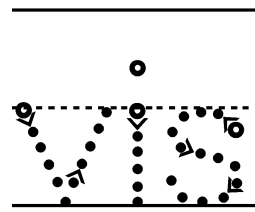
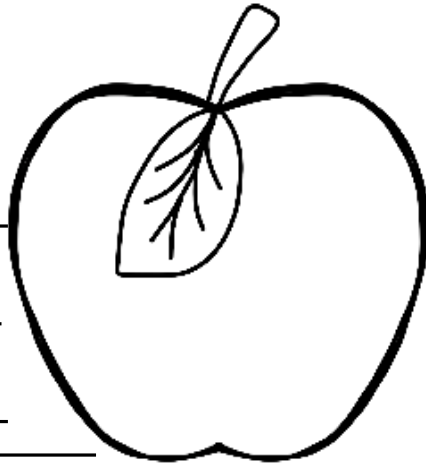
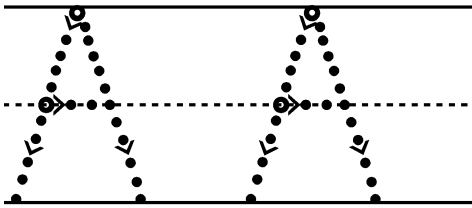
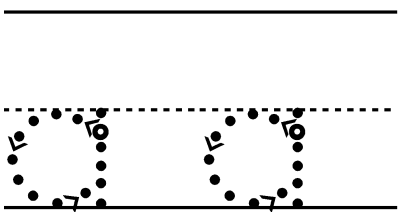
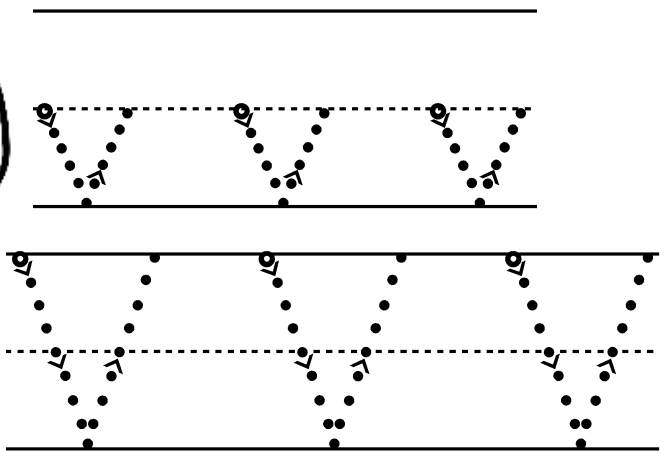
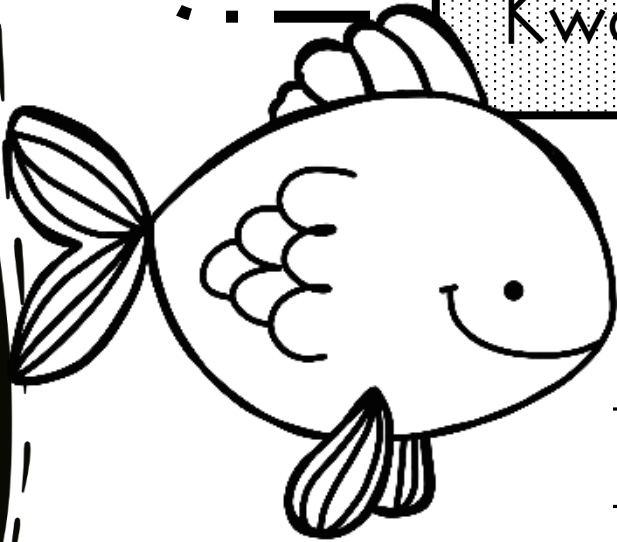

Naam:



Trek jou linkerhand af.

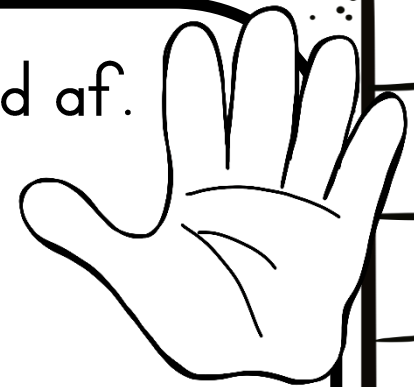

Trek jou regterhand af.

Luister is pret!

Luister na Juffrou en voer die volgende instruksies uit:

1. Kleur die haai grys in.
2. Kleur die krap oranje in.
3. Kleur die seeperdjie pienk in.
4. Kleur die jellievis blou in.
5. Kleur die rots bruin in.
6. Teken vir die see blou golwe.
7. Teken 'n geel son regs bo in die hoek van die blok.

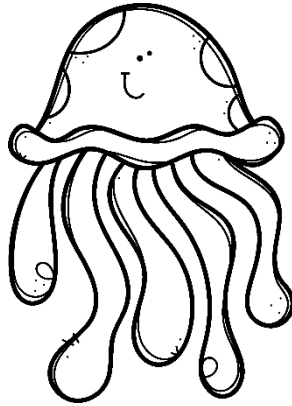
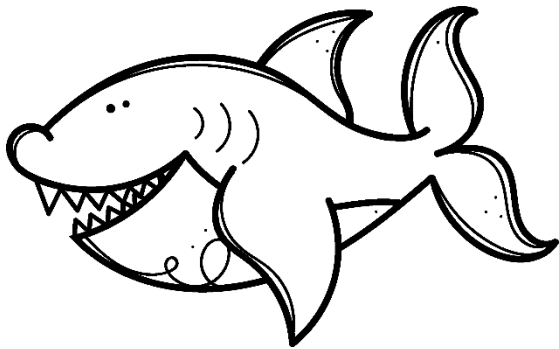

Insekte pret

Help die insekte om by die blom te kom.

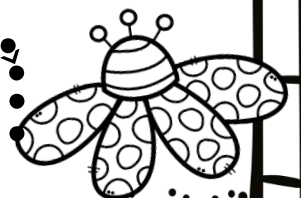
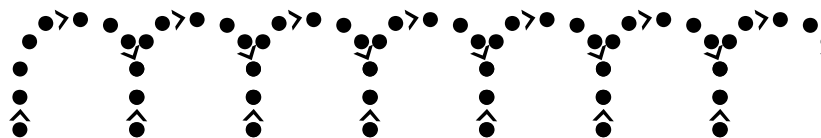
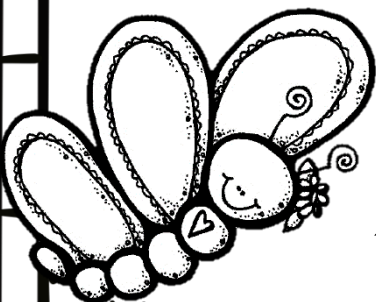
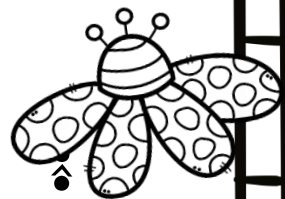
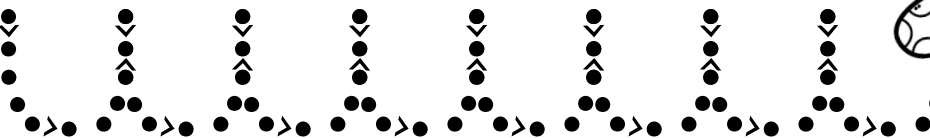
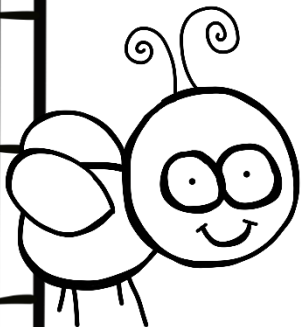
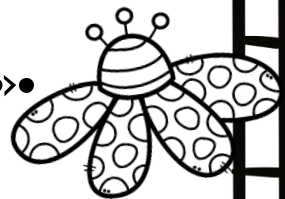
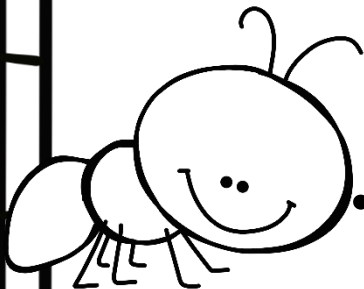
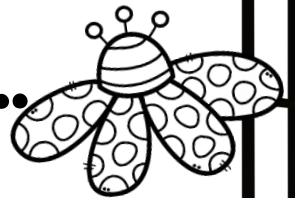
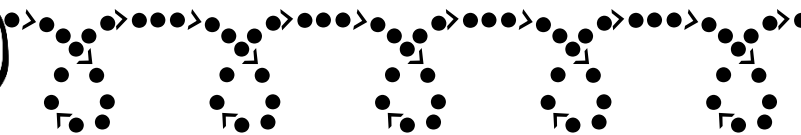
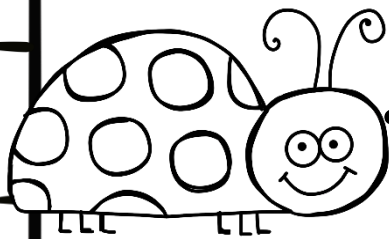
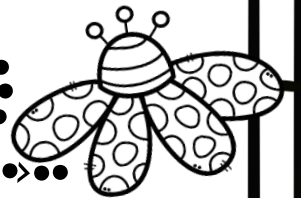
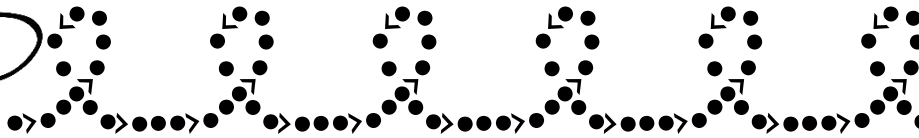
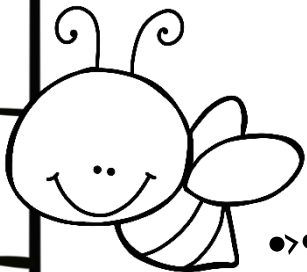

Oefen om jou naam en van te skryf.

Naam

Van

Omkring die eerste letter van jou naam.

G L O I E
Q F C K H
U M S N P
Z X V W Y
J T R
A B D

Oefen die eerste letter van jou naam.

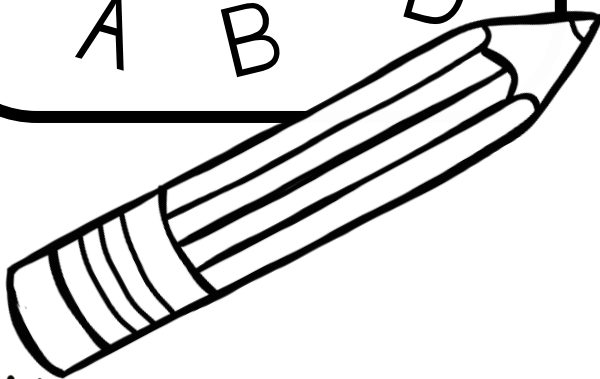

Waar is die kinders?

Sê waar die kinders is.

Die seun lê
onder die
tafel.

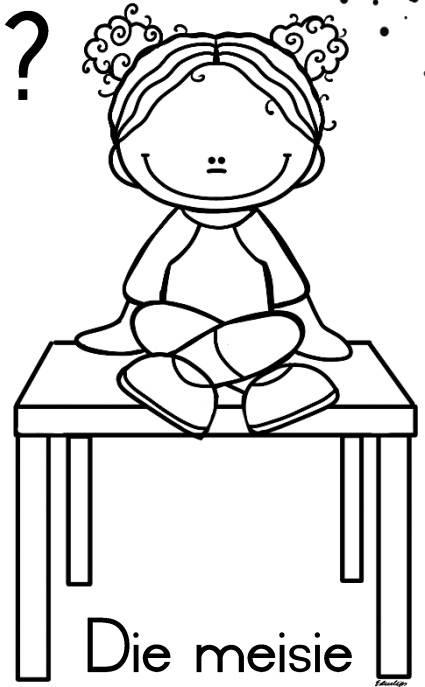
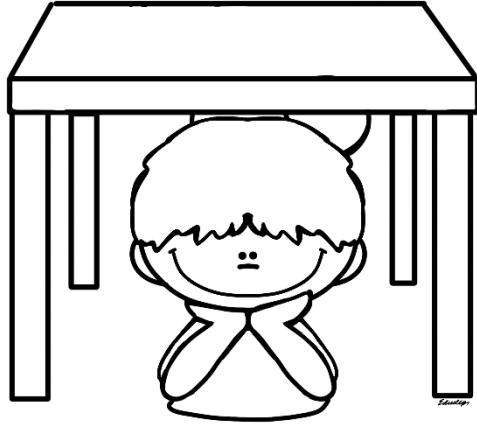

Die meisie
sit bo-op
die tafel.

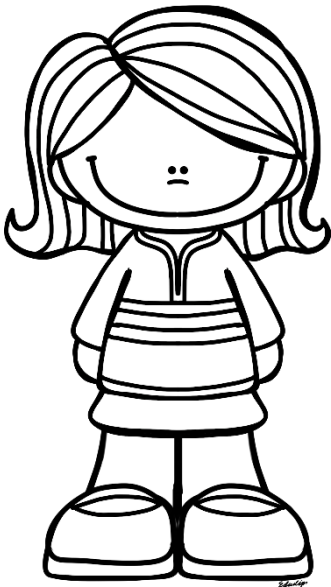

Die meisie
staan langs
die tafel.

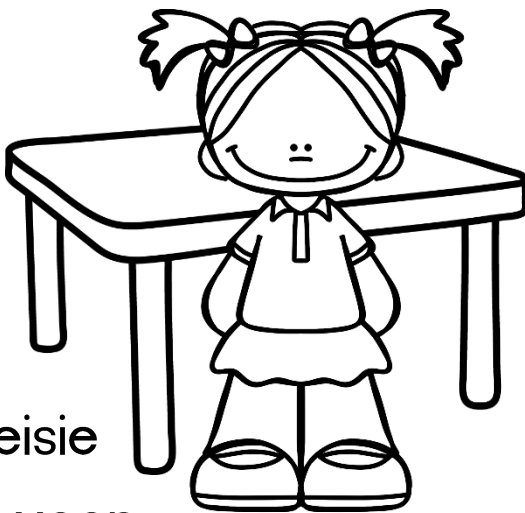

Die meisie
staan voor
die tafel.



Die meisie
staan
agter die
tafel.

Kom ons klank

Kyk na die prente en klank dit vir Juffrou.

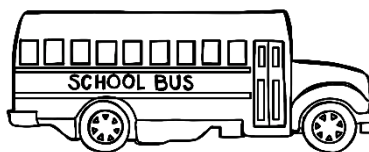
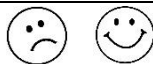
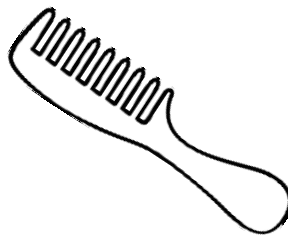
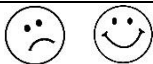
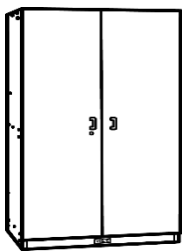
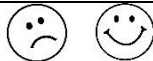
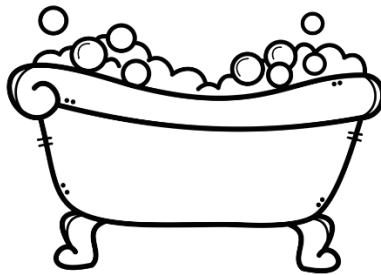
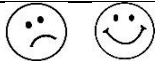
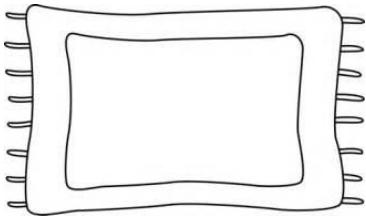
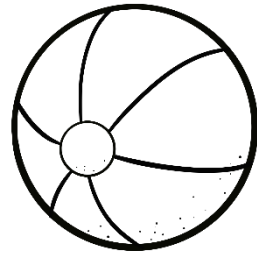
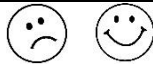
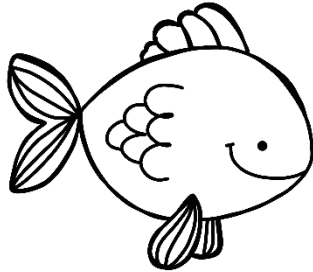
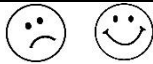

Kleur die prent in wat by die klank pas.

a

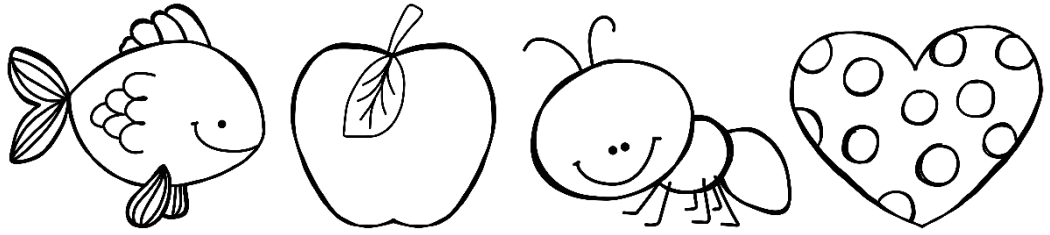

s

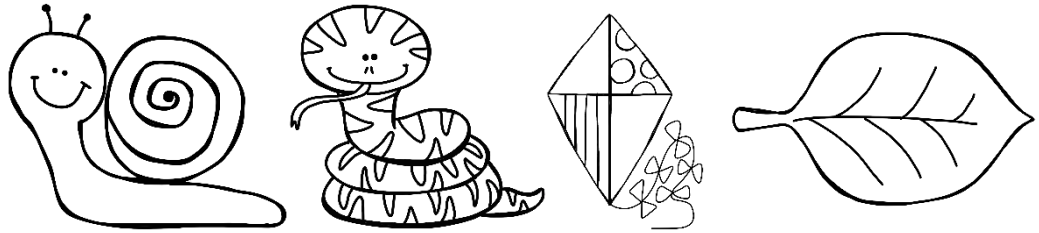

b

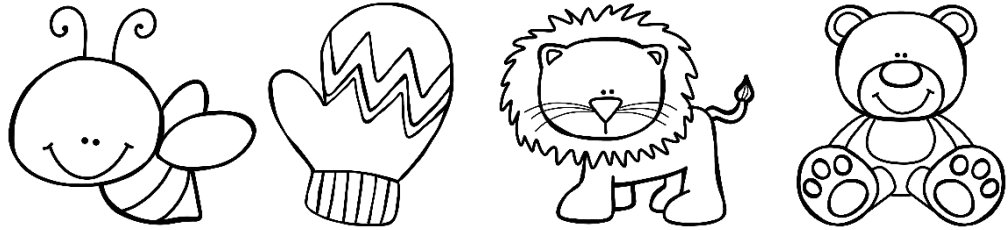

m

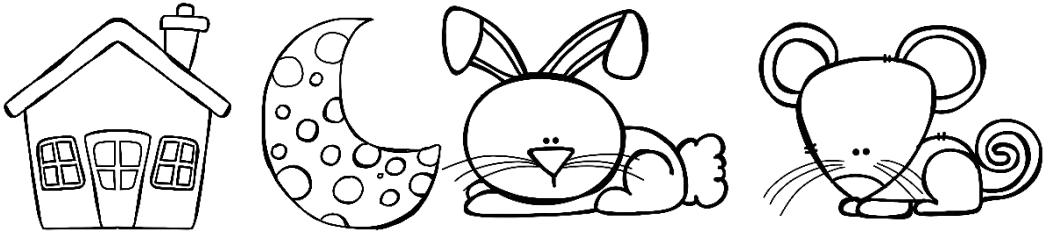

k



e

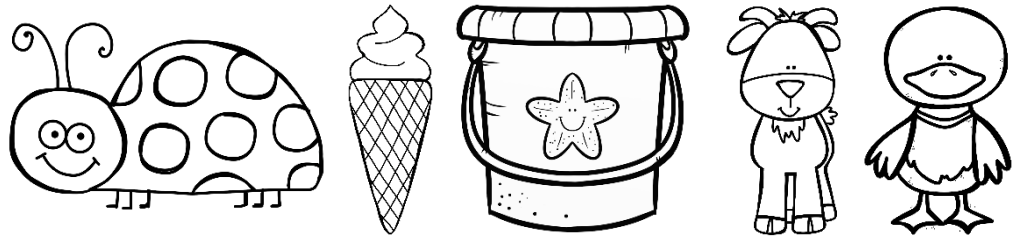

a

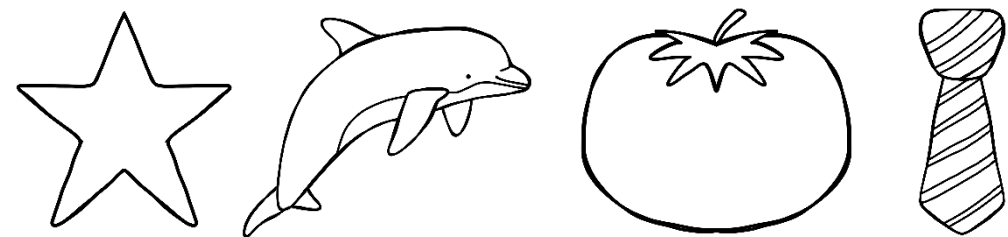

Kleur die "a" in.

l - rooi

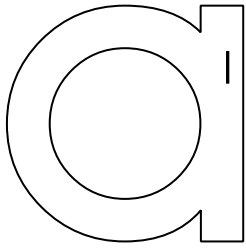

Lees die woorde.

af appel
as akker
agter alles

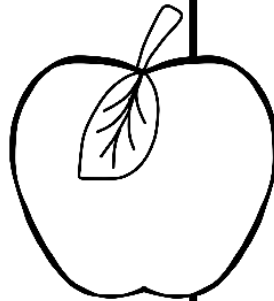
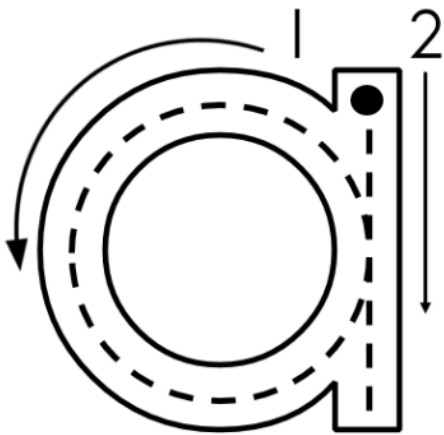

Trek 'n sirkel om die letter a.

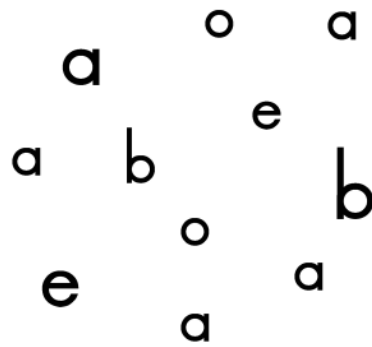

Oefen om die letter te skryf.

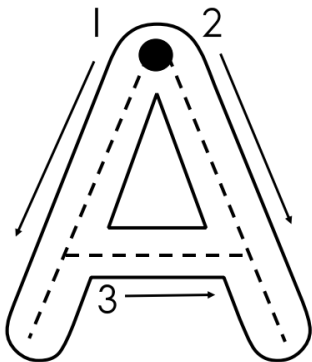
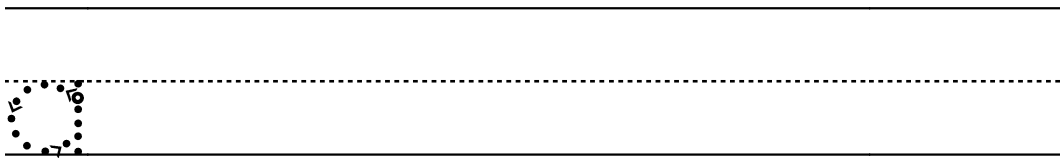

Oefen om die hoofletter te skryf.

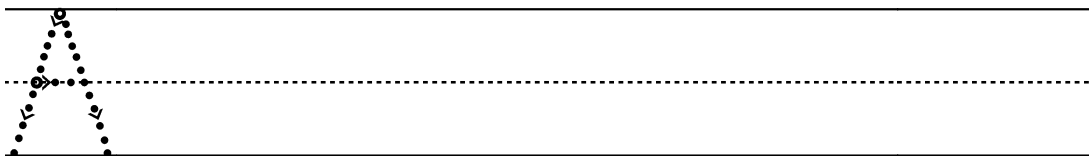

a-klank

Kleur al die prente in wat met 'n a-klank begin.

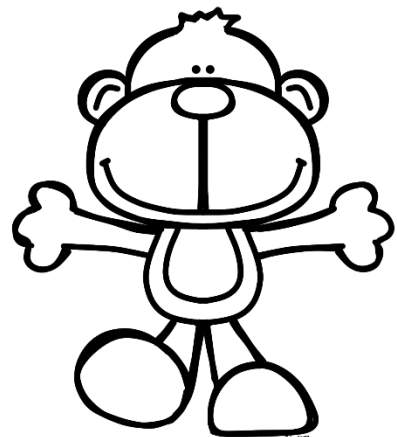
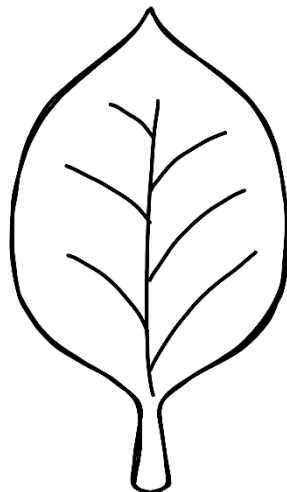
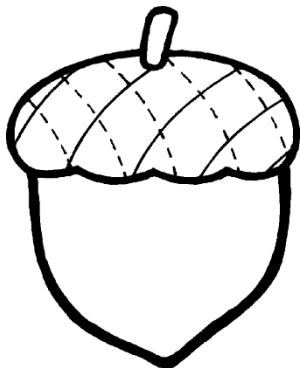
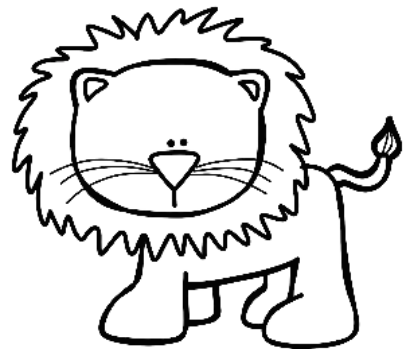
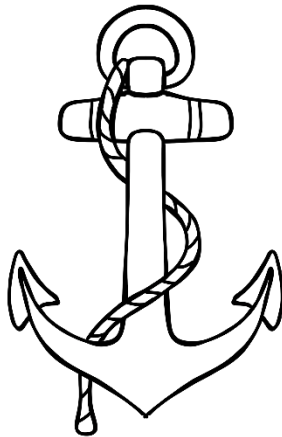
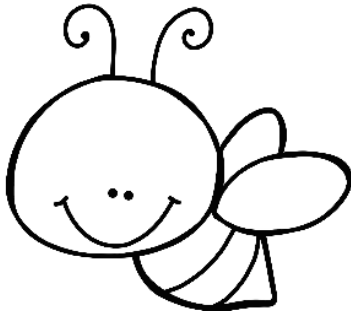
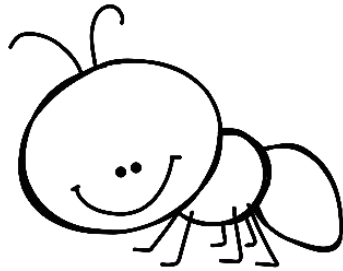
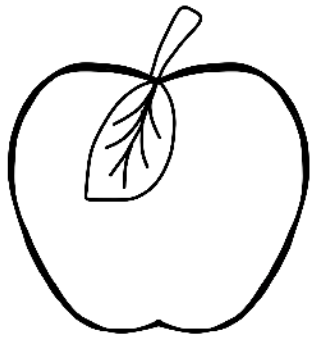

Kleur die prente in wat soos die eerste een lyk.

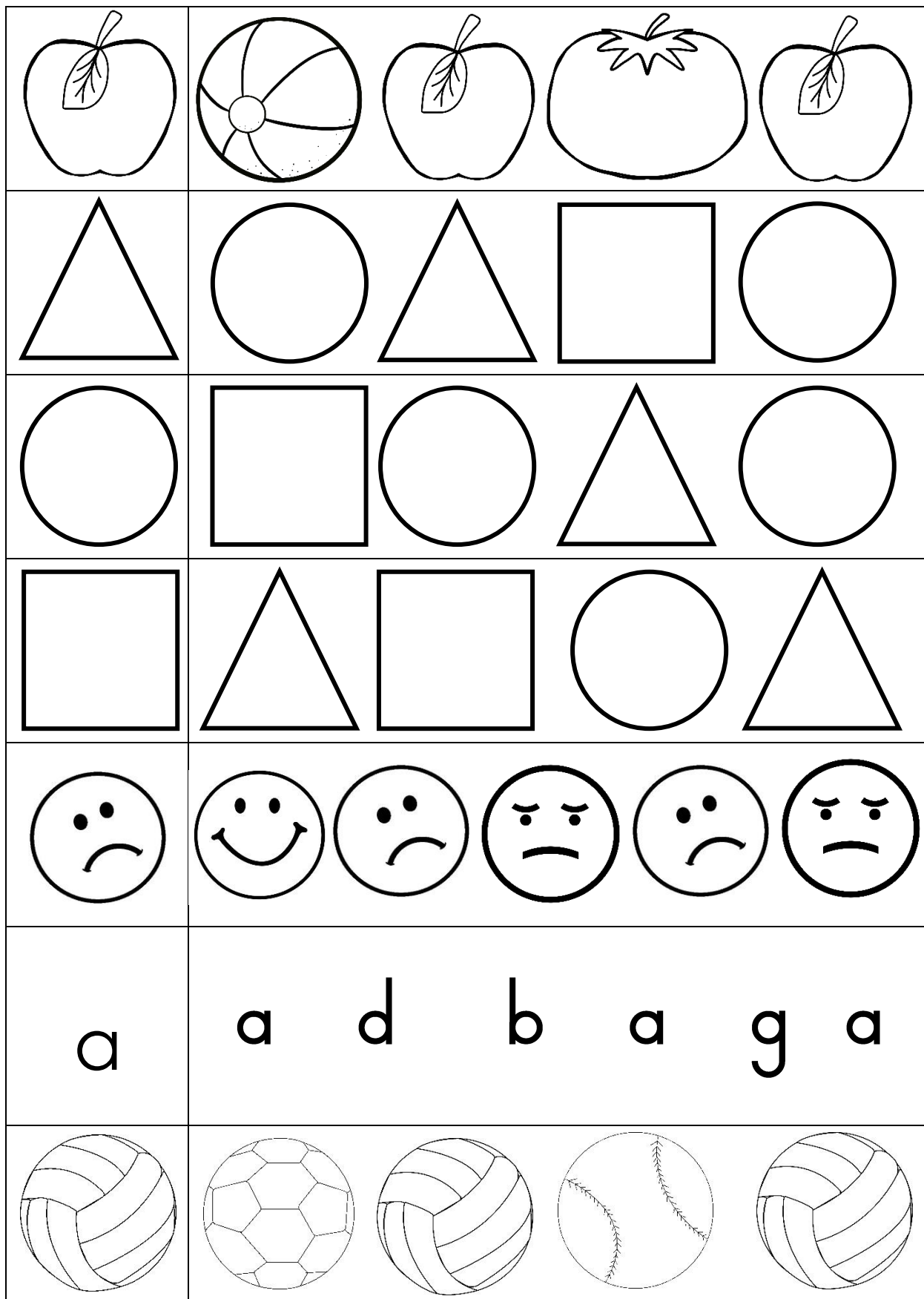

Kleur die "s" in.

I - pers

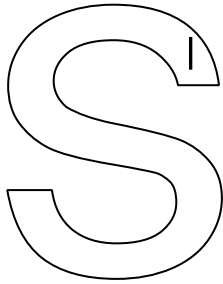

Lees die woorde.

saag	saad	see	sê	son
sop	sog	sal	sag	sap
sit	sif	lees	fees	kaas

Trek oor die letter.



Omkring al die s-klanke.

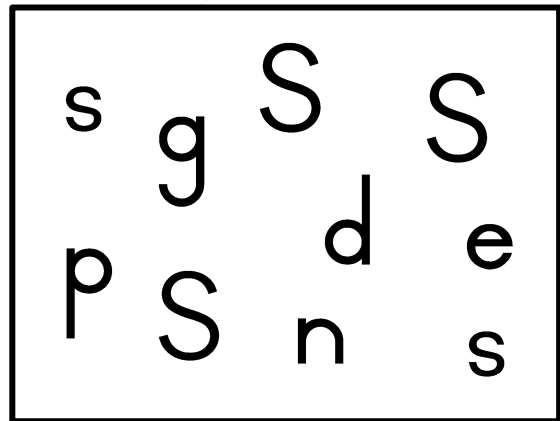

Oefen om die letter te skryf.

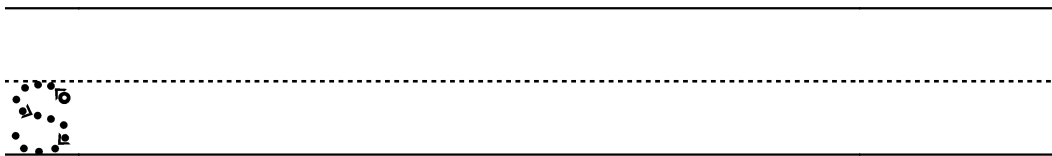

Skryf oor die woorde.

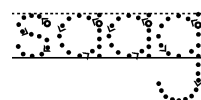
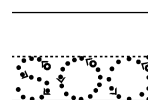
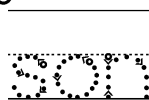
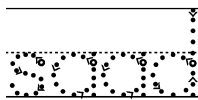

Oefen om die hoofletter te skryf.



s-klank

Kleur al die prente in wat met 'n s-klank begin.

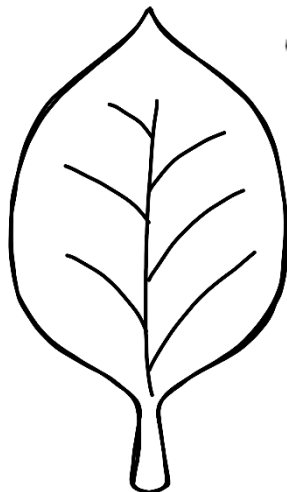
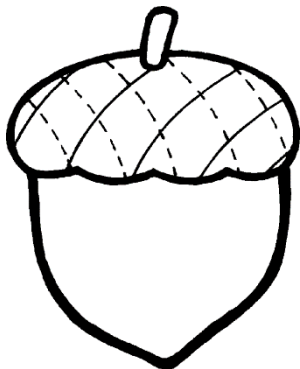
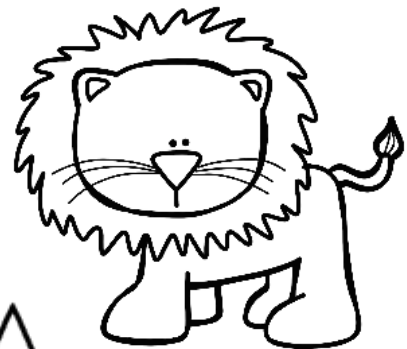
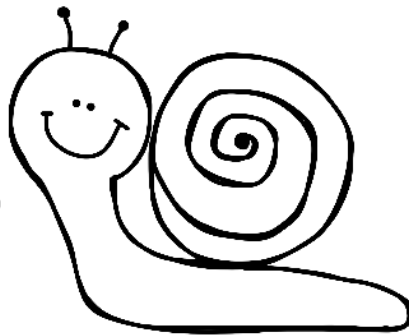
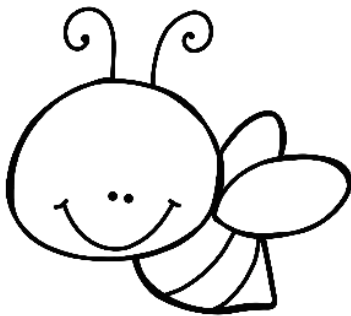
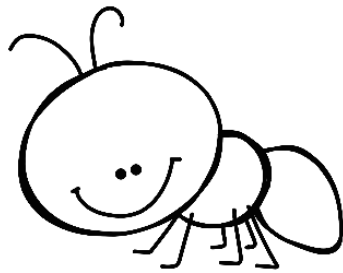
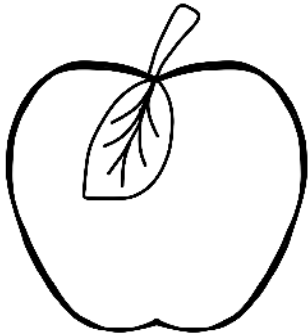

Kleur die "o" in.

I - blou

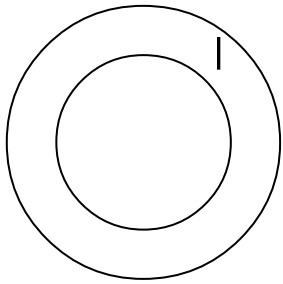

Lees die woorde.

hok	kos	stok	of	os
blom	pos	klok	op	ot
hond	kolle	boks	pop	sop

Trek oor die letter.

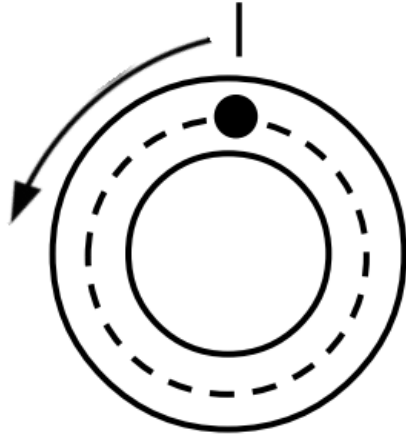
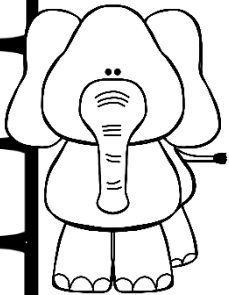

Omkring al die o-klanke.

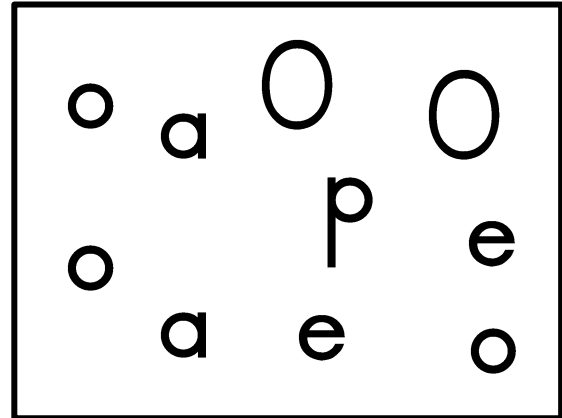

Oefen om die letter te skryf.

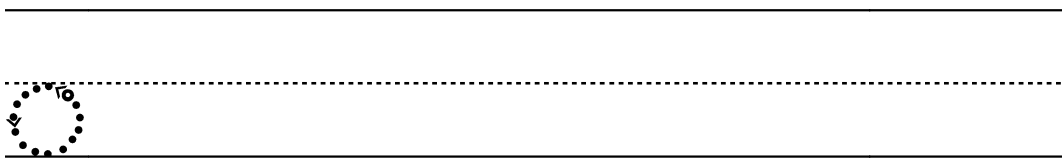

Vul die o-klanke op die regte plekke in.

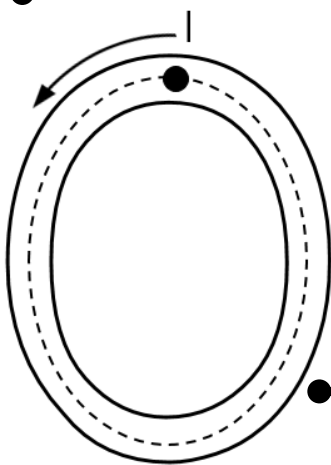

st__k		__p		bl__m
k__s		__f		p__s

Oefen om die hoofletter te skryf.

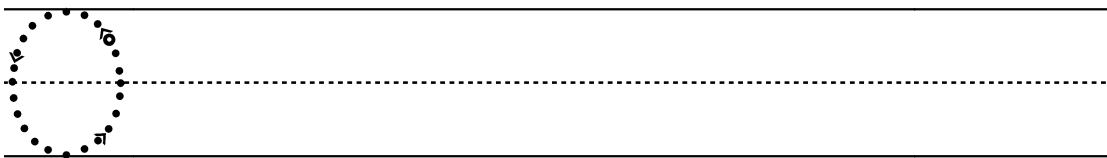

o-klank

Kleur al die prente in wat met 'n o-klank begin.

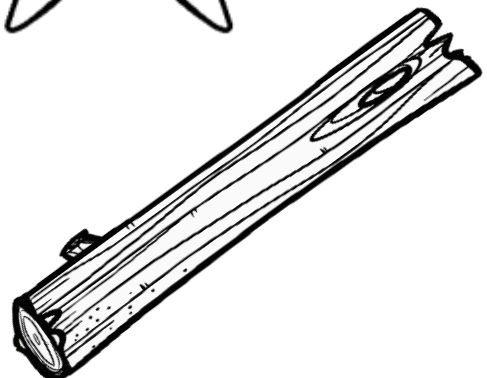
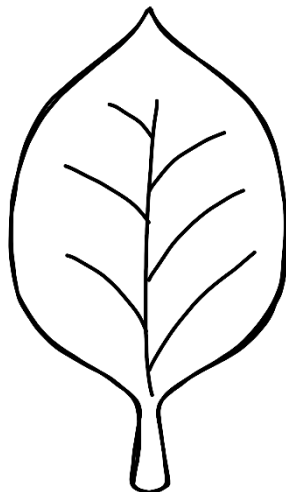
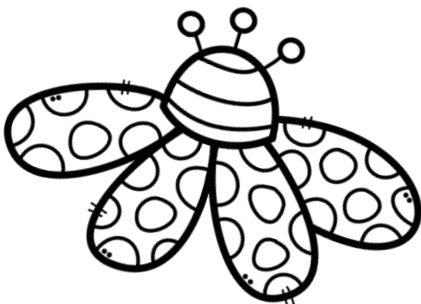
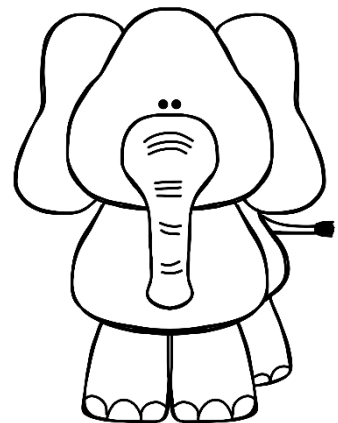
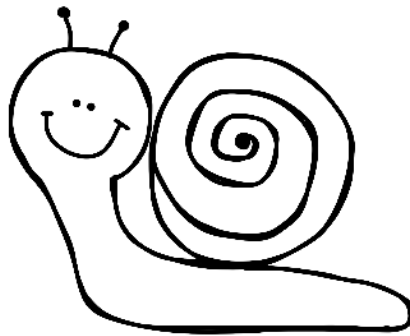
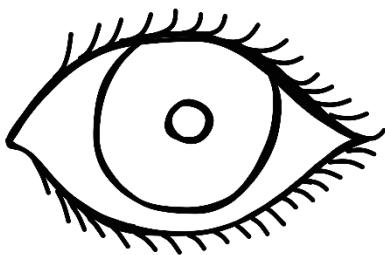
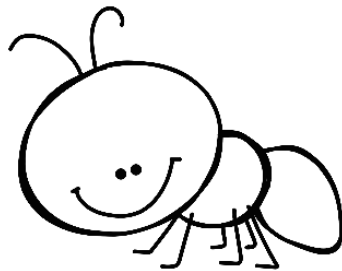
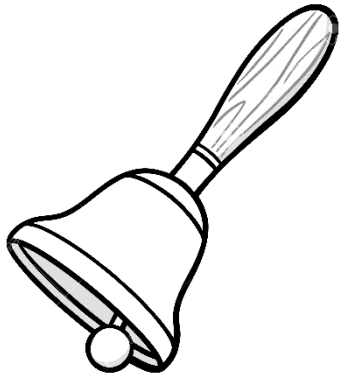

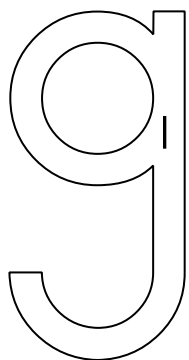

Kleur die "g" in.

l - groen

Lees die woorde.

gaan	gaaf	gif	geen
geel	gips	gras	gans
geld	goud	glas	gooi

Trek oor die letter.

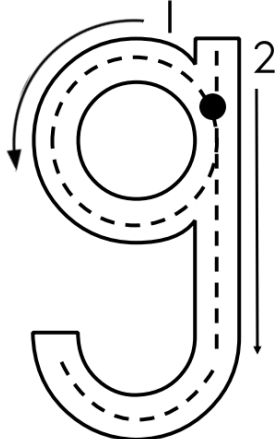
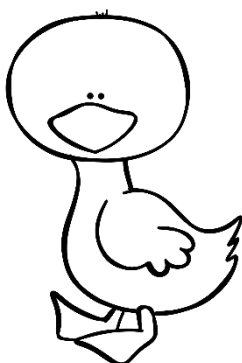

Omkring al die g-klanke.

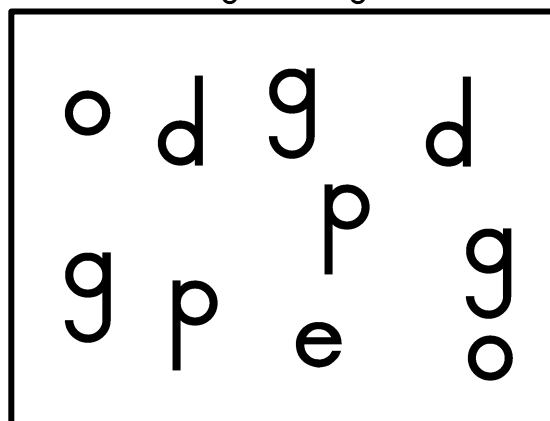

Oefen om die letter te skryf.

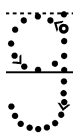

Vul die g-klanke op die regte plekke in.

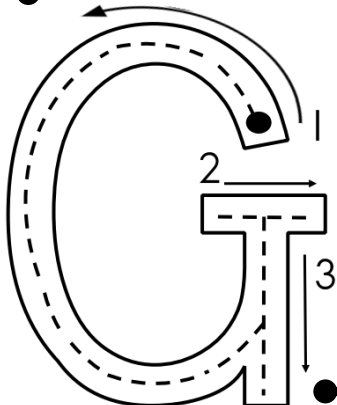

__ans		__eld
__ras		__oud

Oefen om die hoofletter te skryf.

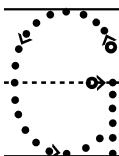

g-klank

Kleur al die prente in wat met 'n g-klank begin.

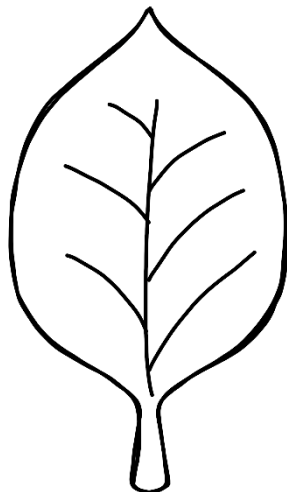
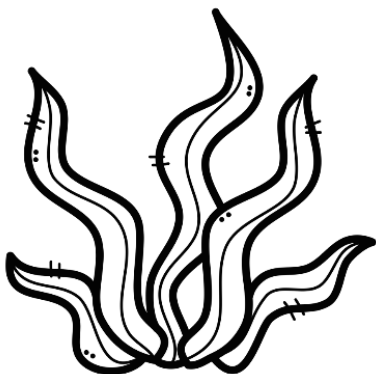
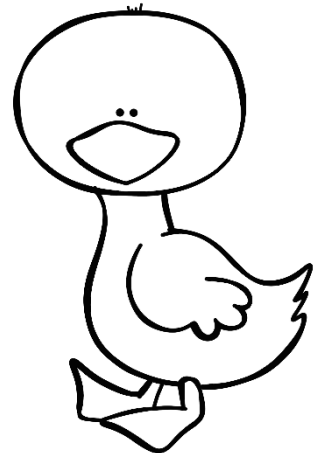
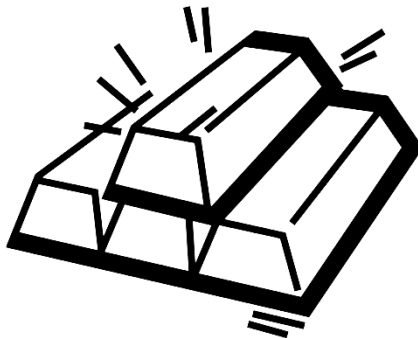
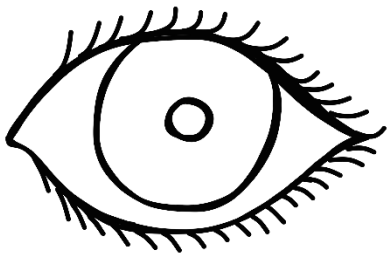
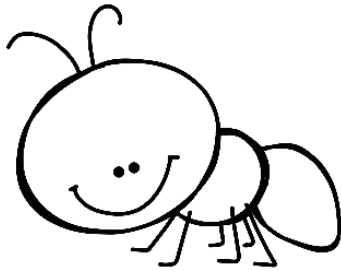
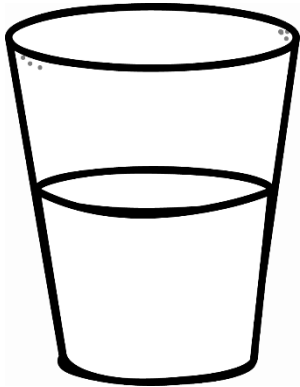

Kleur die "l" in.



l - geel

Lees die woorde.

lig	lag	les	las
lol	los	loop	lepel
leeu	lappop	lamp	lyf

Trek oor die letter.

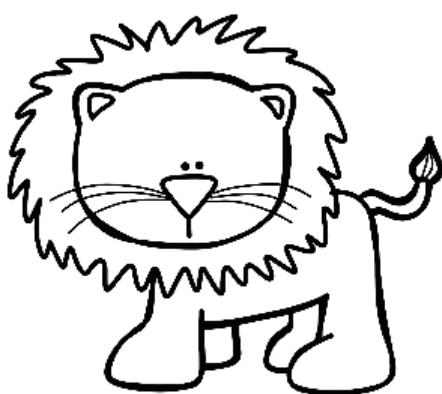

Omkring al die l-klanke.

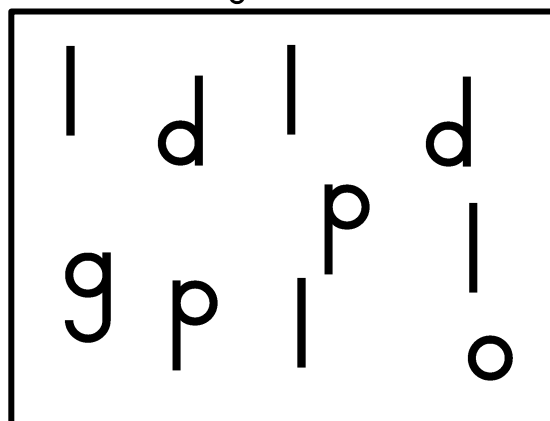

Oefen om die letter te skryf.

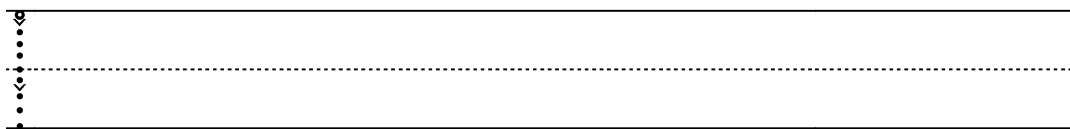

Vul die l-klanke op die regte plekke in.

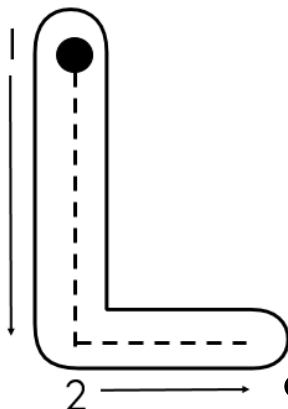

__ amp

__ oop

__ eeu

__ ag

Oefen om die hoofletter te skryf.

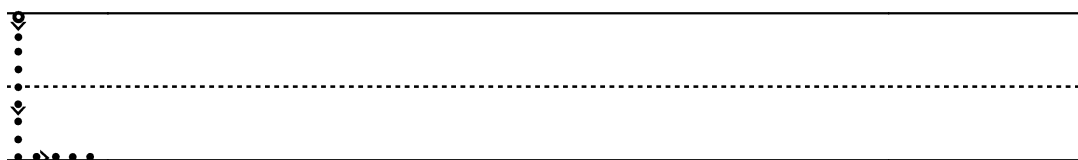

I-klank

Kleur al die prente in wat met 'n I-klank begin.

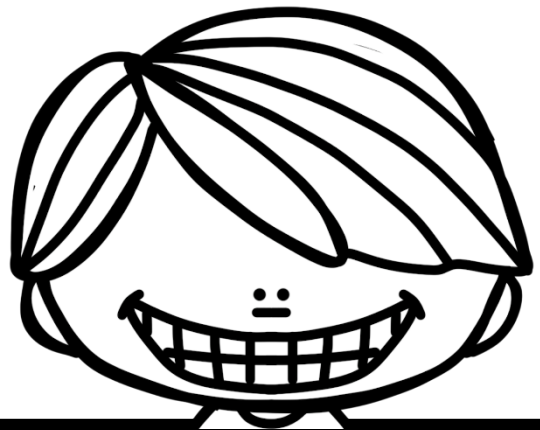
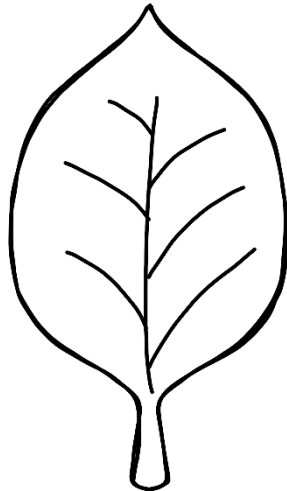
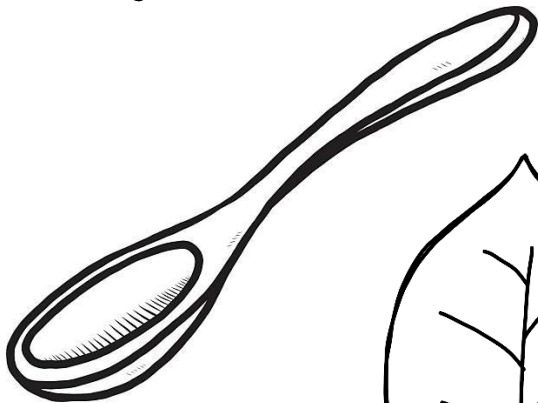
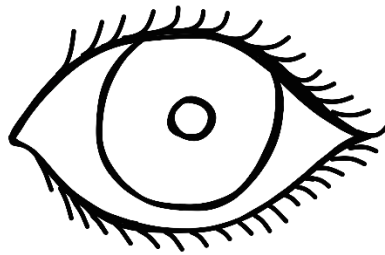
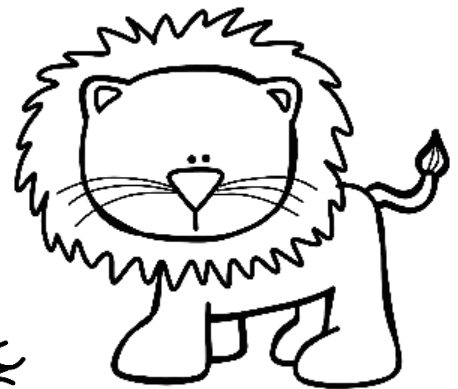
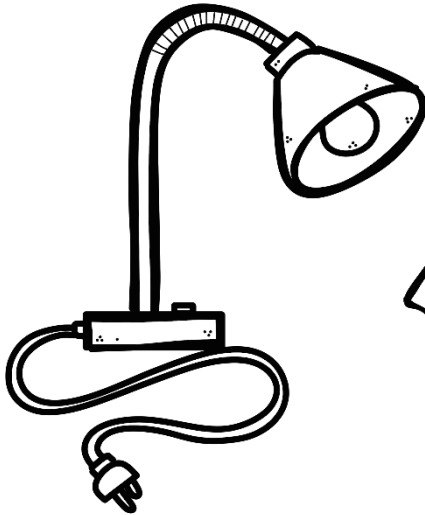
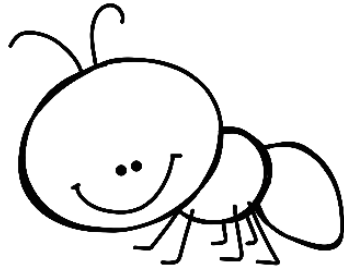

Kleur die "w" in.

I - pienk

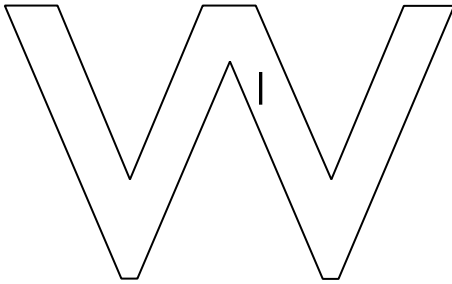

Lees die woorde.

wag	wurm	weg	walvis
wol	water	wie	wil
weer	wiel	was	waar

Trek oor die letter.



Omkring al die w-klanke.

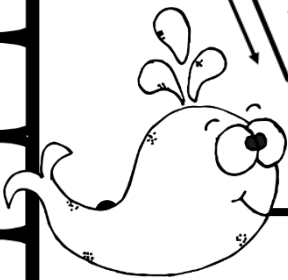
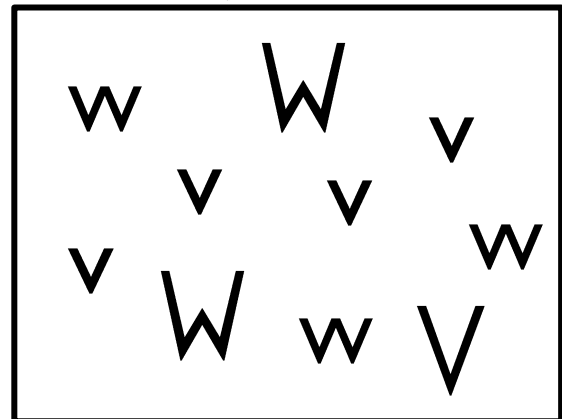

Oefen om die letter te skryf.

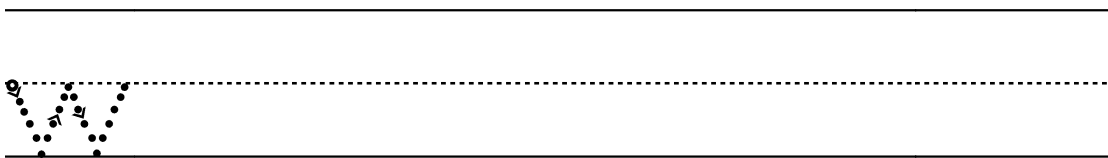

Vul die w-klanke op die regte plekke in.

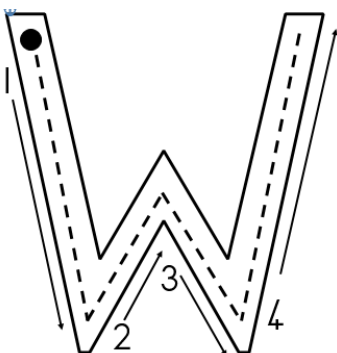

___alvis

___eg

___aar

___ie

___eer

___il

Oefen om die hoofletter te skryf.

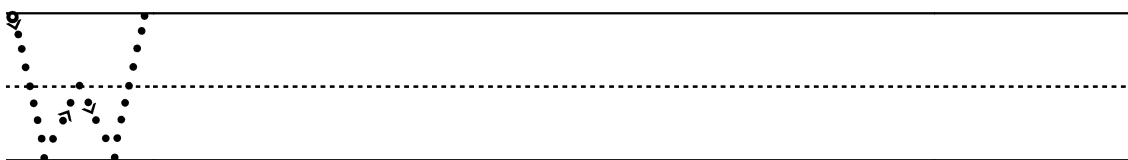

w-klank

Kleur al die prente in wat met 'n w-klank begin.

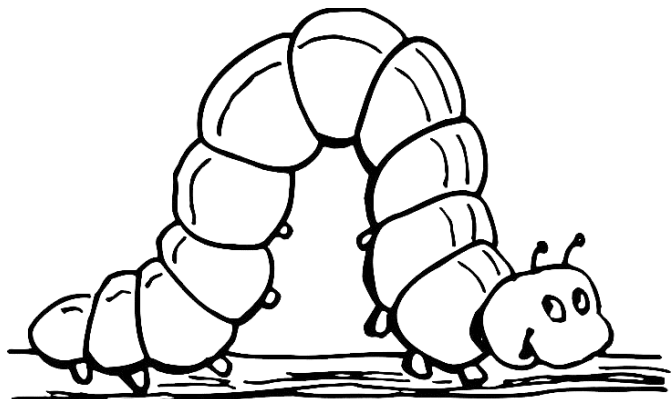
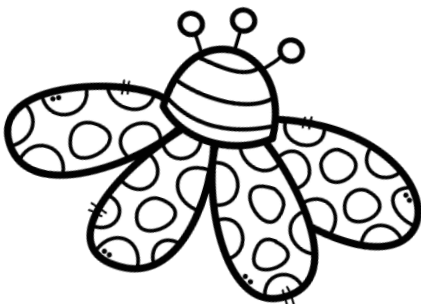
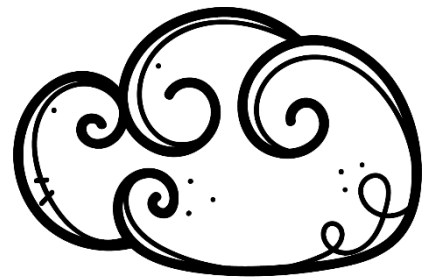
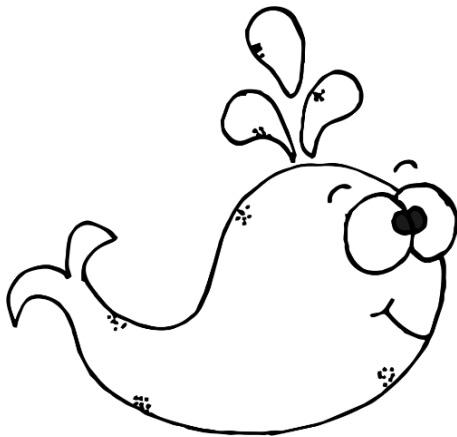
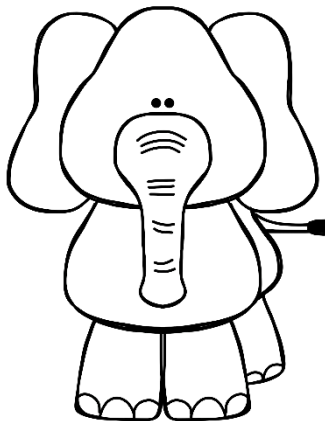
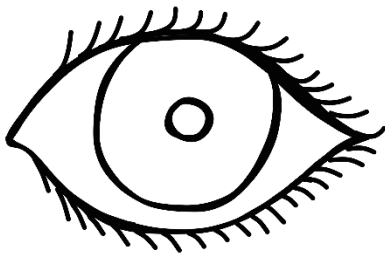
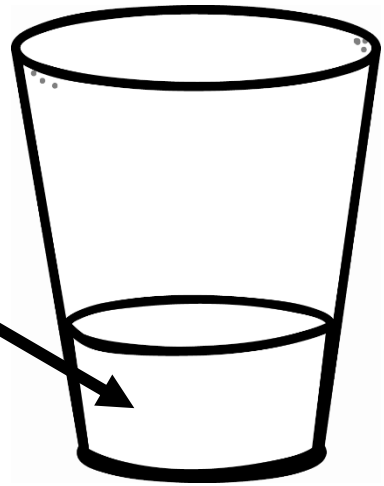
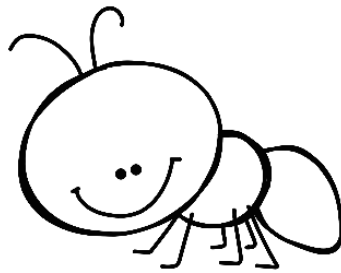
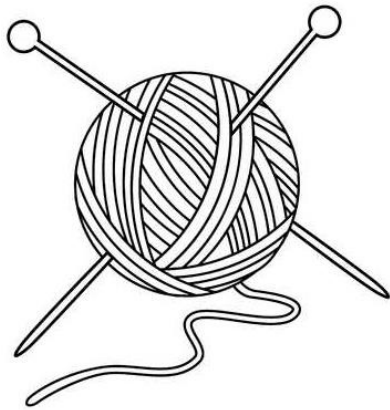

Kleur die "i" in.



1 - pers

2 - groen

Lees die woorde.

ink	lip	insek	vis
is	dis	kis	gis
sis	wil	bid	rits

Trek oor die letter.

2

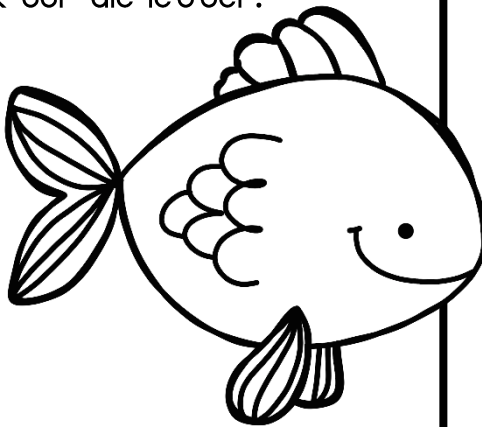

Omkring al die i-klanke.

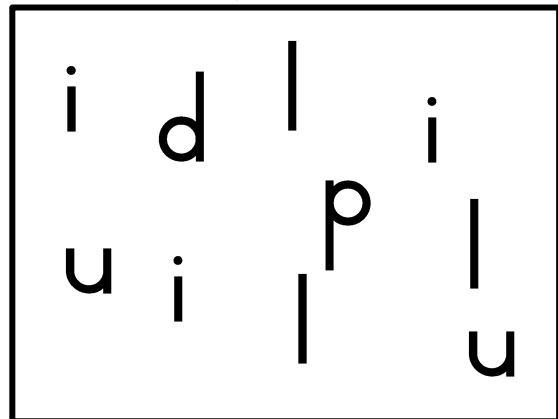

Oefen om die letter te skryf.

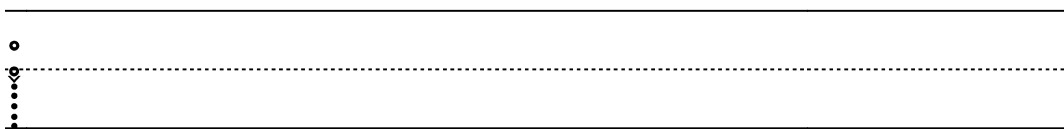

Vul die i-klanke op die regte plekke in.

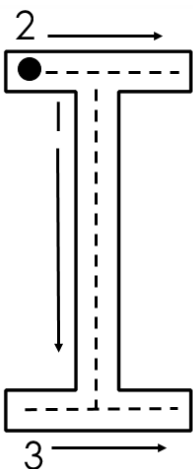

l _ p

_ nsek

_ nk

v _ s

Oefen om die hoofletter te skryf.

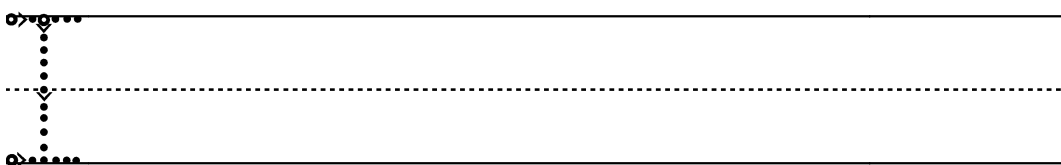

i-klank

Kleur al die prente in wat met 'n i-klank begin.

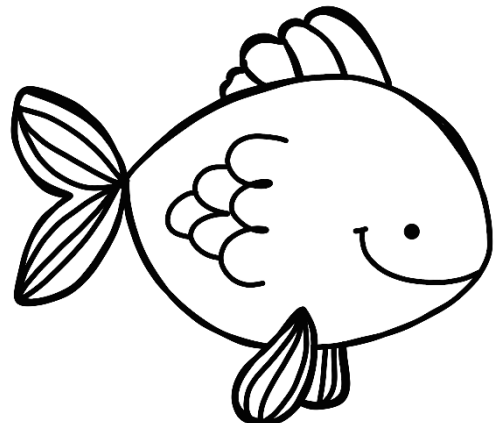
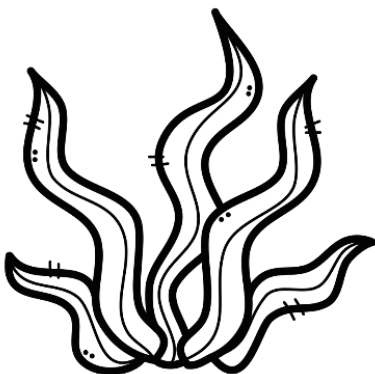
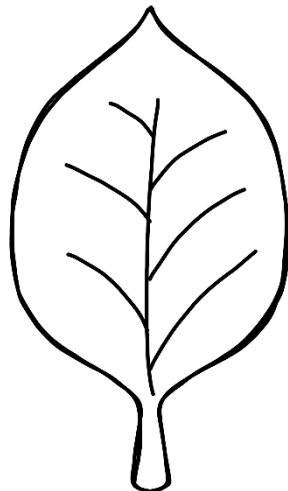
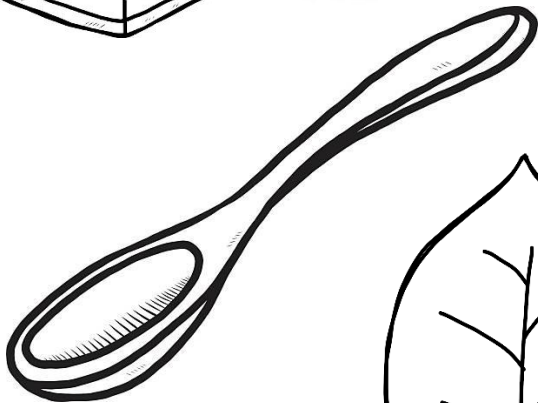
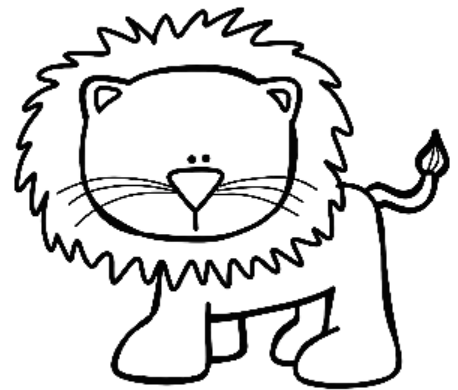
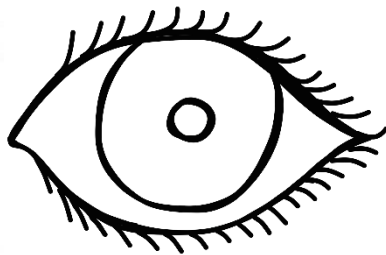
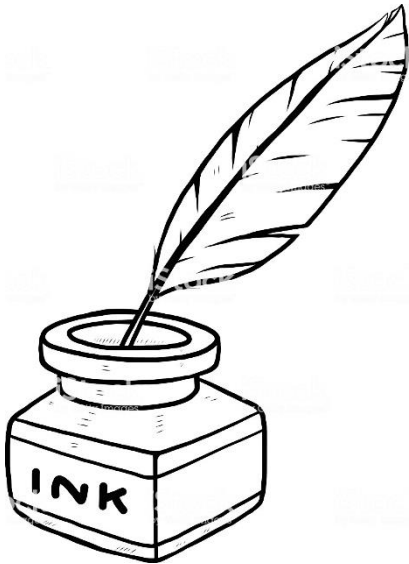
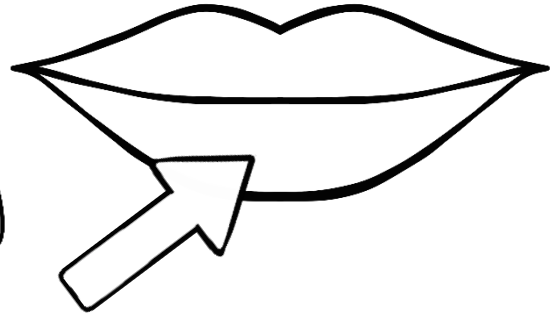
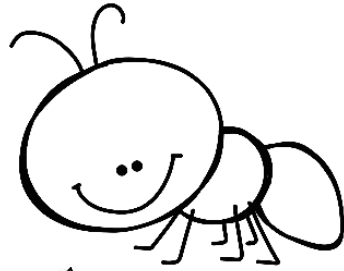

Kleur die "k" in.

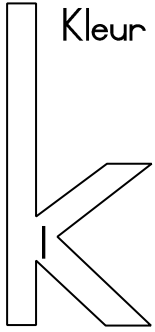

l - pers

Lees die woorde.

kat	kas	kam	kom	kos
kol	kul	keer	keel	kyk
koei	kar	kap	kok	kot

Trek oor die letter.

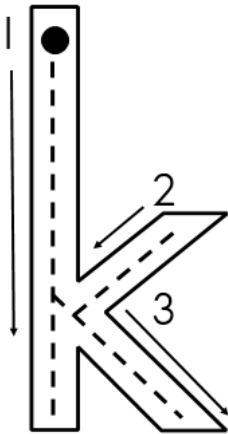

Omkring al die k-klanke.

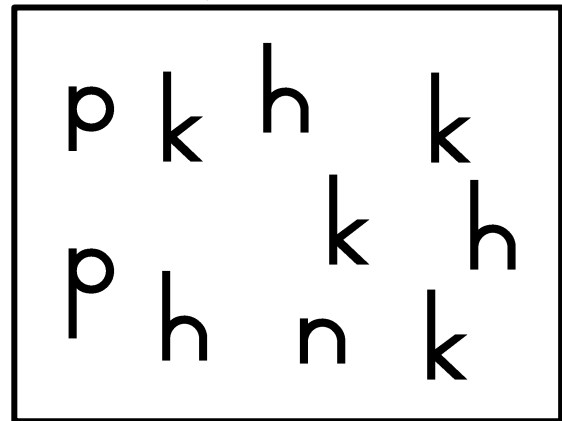

Oefen om die letter te skryf.

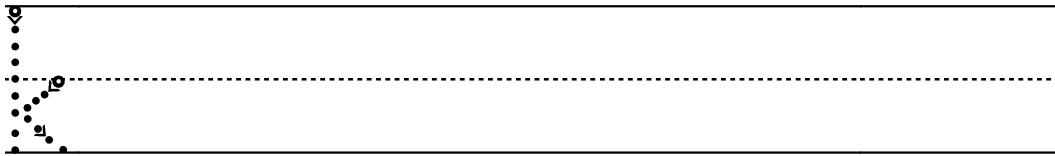

Skryf oor die woorde.

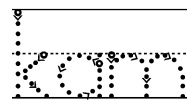
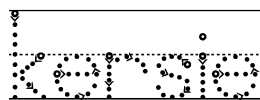
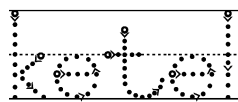
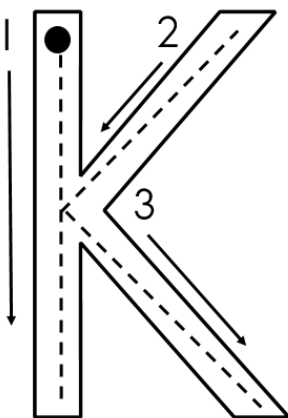

Oefen om die hoofletter te skryf.

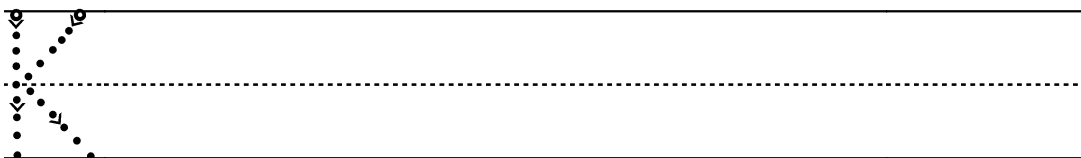

k-klank

Bou die woorde met die k-klank.

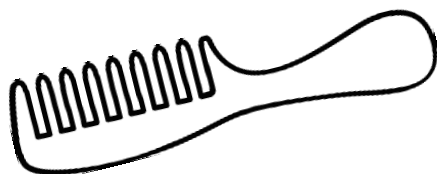

ka



f

kaf

s

m



ko

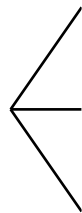

l

s

k

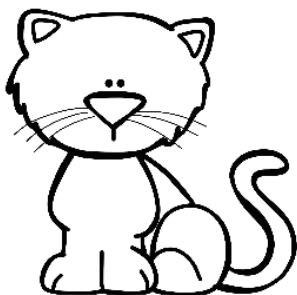

ka

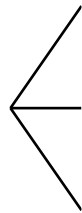

r

p

t

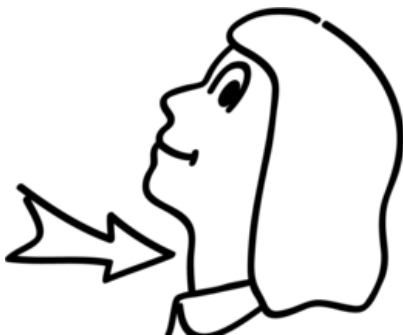

kee

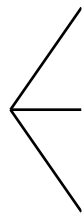

l

r

s

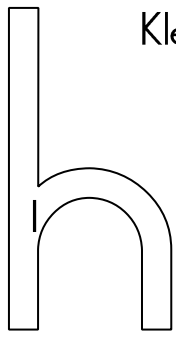

Kleur die "h" in.

l - grys

Lees die woorde.

hak	hok	haas	hik	hier
hoor	hop	huis	hut	hart

Trek oor die letter.

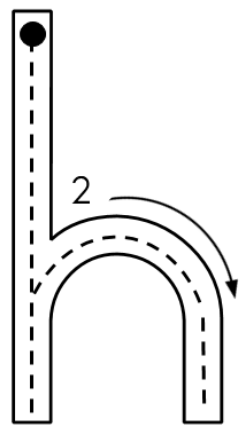

Omkring al die h-klanke.

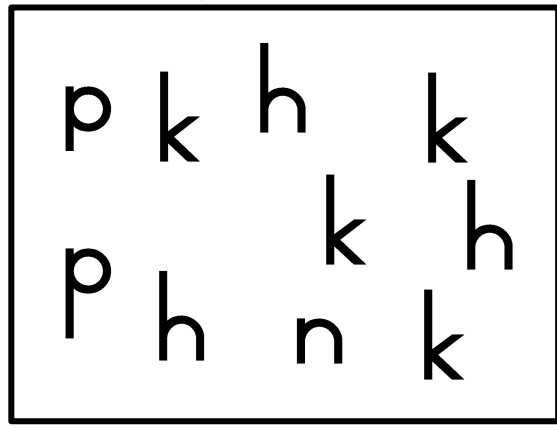

Oefen om die letter te skryf.

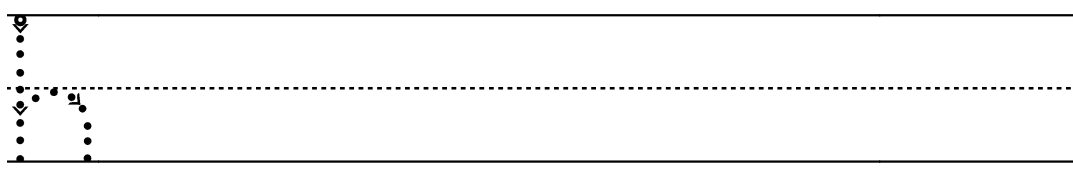

Skryf oor die woorde.

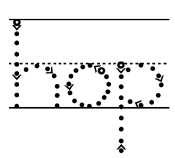
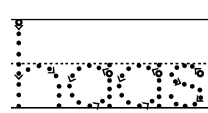
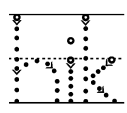
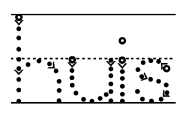
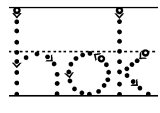
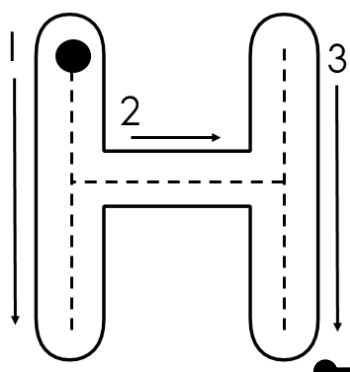

Oefen om die hoofletter te skryf.

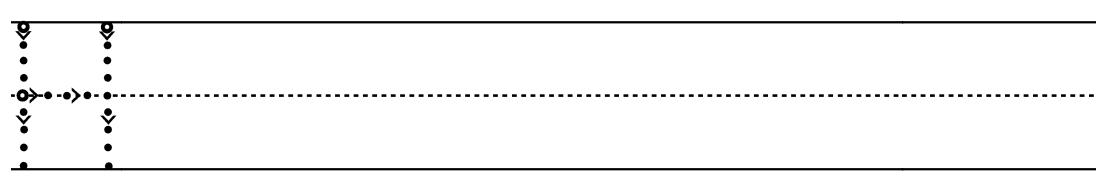

h-klank

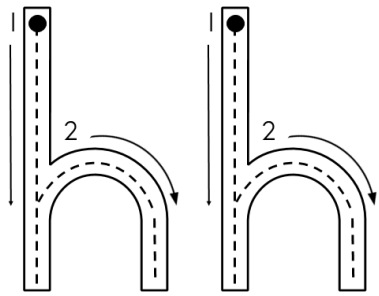
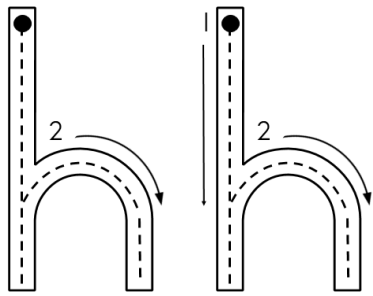

Voltooi die woorde.

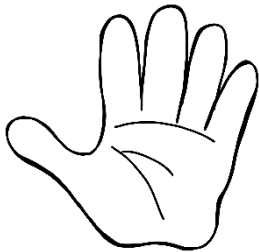

__and

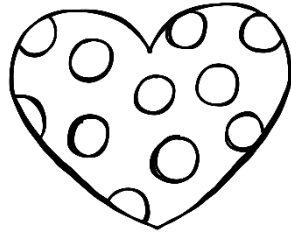

__art



__uis

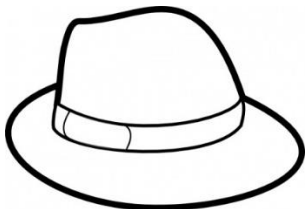

__oed

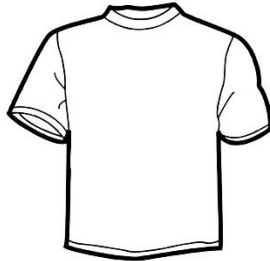

__emp



__ut

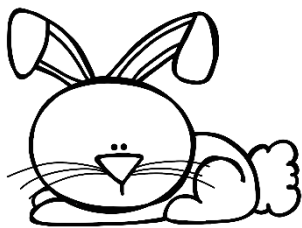

__aas



__ok



__ond

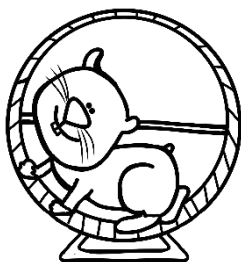

__amster

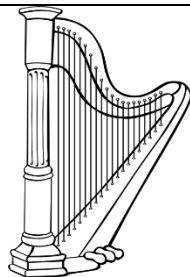

__arp

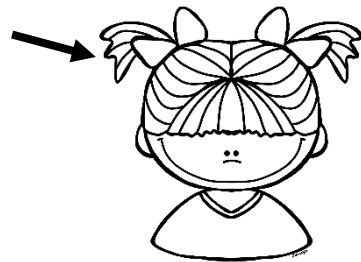

__are

Kleur die "u" in.

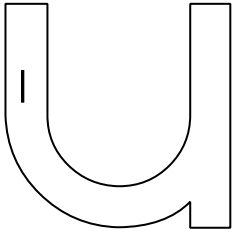

l - blou

Lees die woorde.

mus	bus	lus	gun
vul	kul	bul	nul
dun	jul	rus	sus

Trek oor die letter.

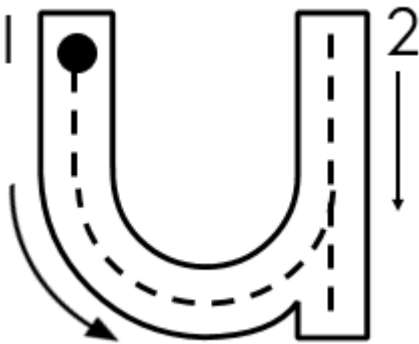

Omkring al die u-klanke.

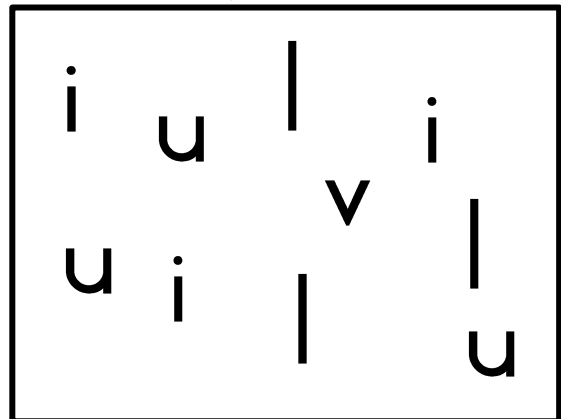

Oefen om die letter te skryf.

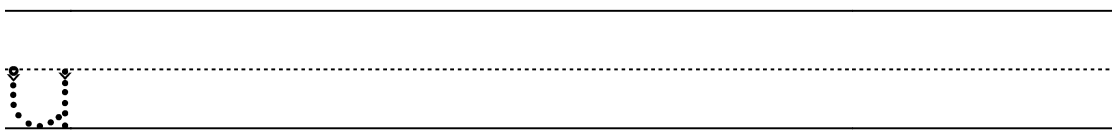

Vul die i-klanke op die regte plekke in.

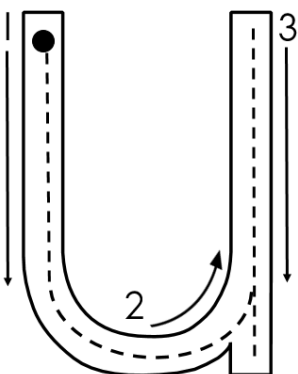

s _ s

b _ l

n _ l

m _ s

b _ s

v _ l

Oefen om die hoofletter te skryf.

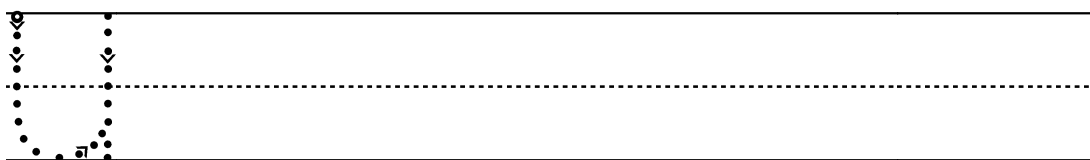

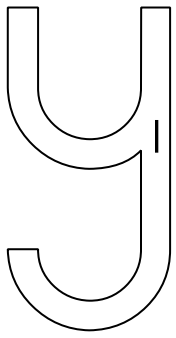

Kleur die "y" in.

l - pers

Lees die woorde.

my	hy	ys	wys
kyk	lyk	ry	yster

Trek oor die letter.

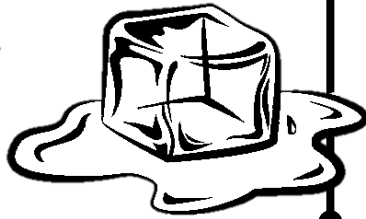
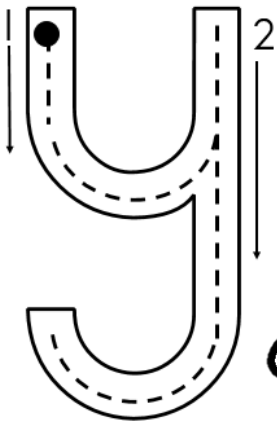

Omkring al die y-klanke.

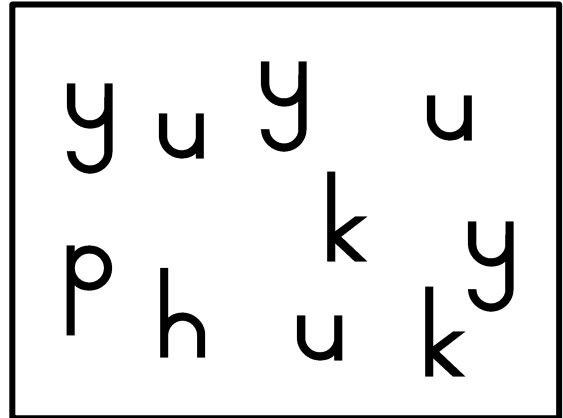

Oefen om die letter te skryf.

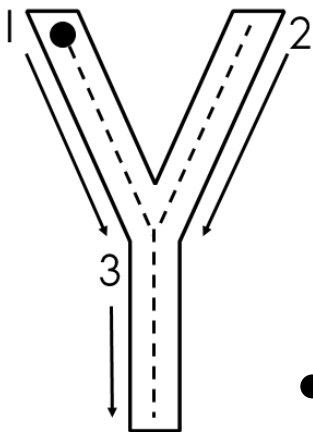
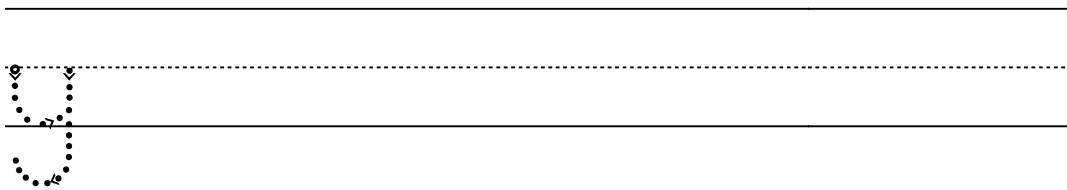

Skryf oor die woorde.

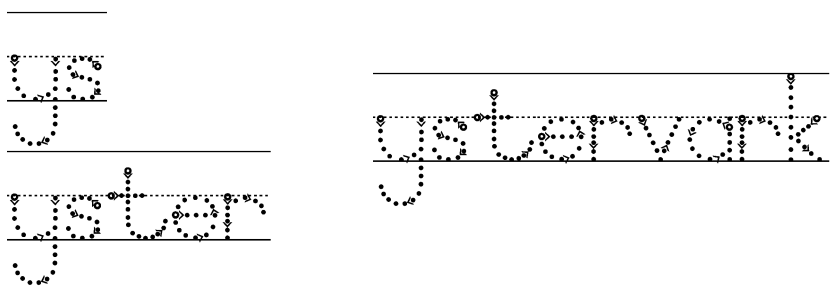

Oefen om die hoofletter te skryf.

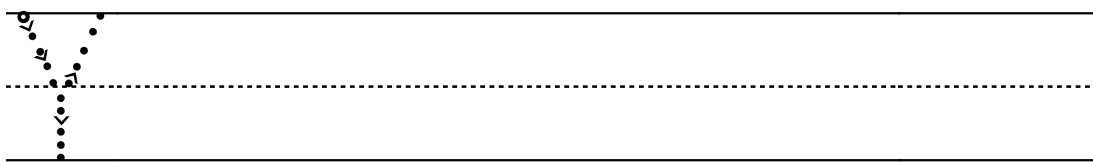

u en y-klank

- Kleur al die prente wat met 'n u as middelklank BLOU in.
- Kleur al die prente wat met 'n y-klank begin en as middelklank het PERS in.

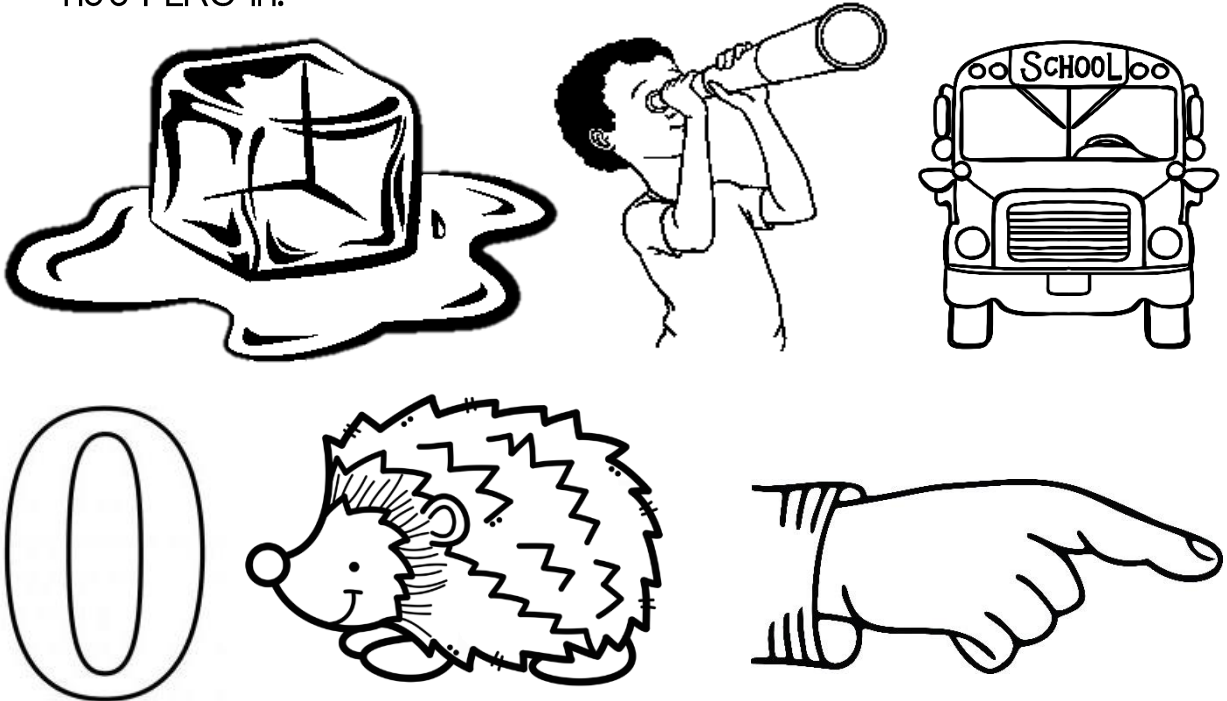

Voltooi die woorde.

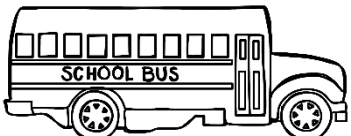
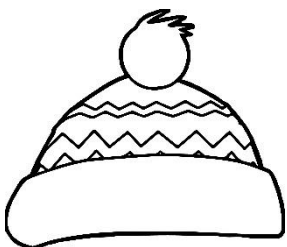
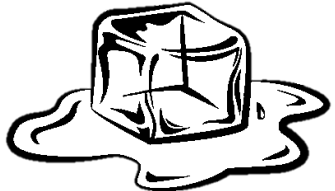
		
b__s	m__s	__s

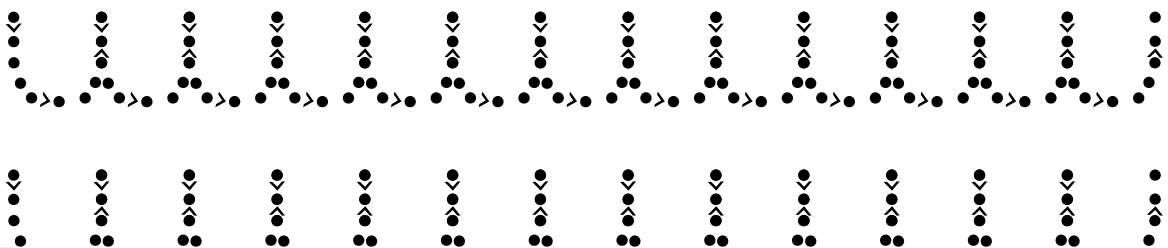

Beginklanke

Met watter letter begin die volgende woorde?

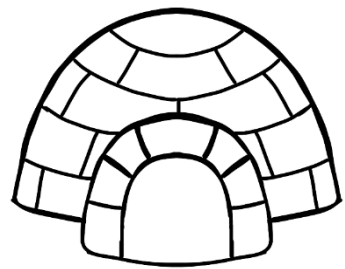
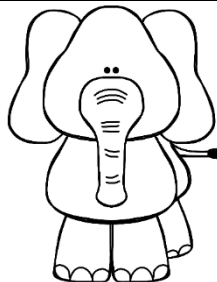
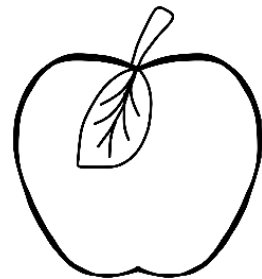
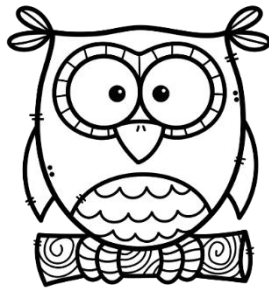
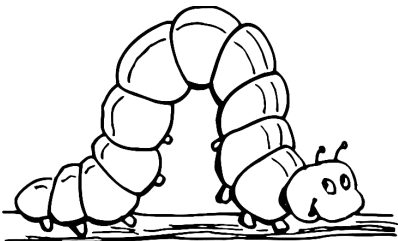
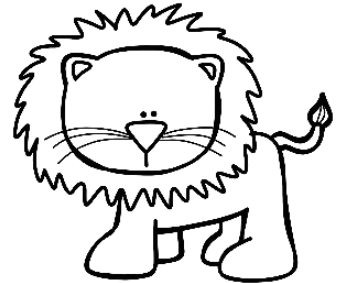
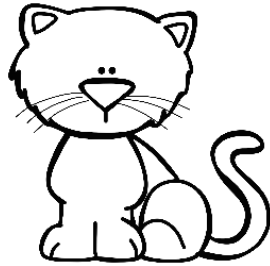

Rymwoorde

Kleur die prent jie in wat rym met die prent jies in die eerste blok.

Woorde wat rym klink **dieselfde**.

