

GRAAD 1

AFRIKAANS HUISTAAL

Kwartaal 2

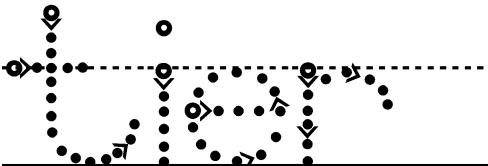
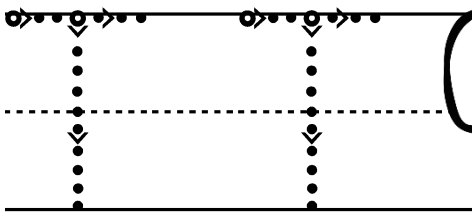
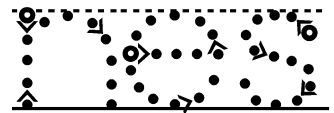
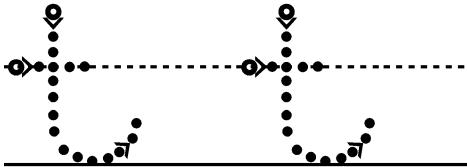
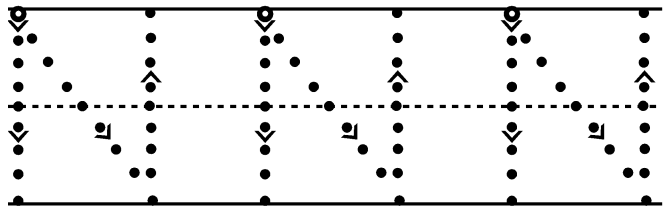
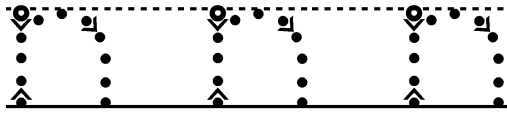
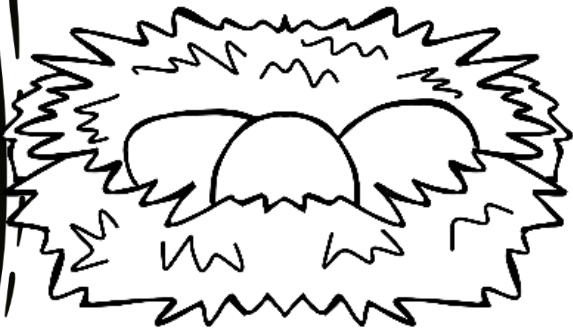

Naam:

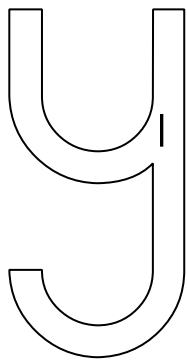

Kleur die "y" in.

l - groen

Lees die woorde.

ys	my	kyk	vy
wys	hy	lyk	kry
yster	ystervark		

Trek oor die letter.

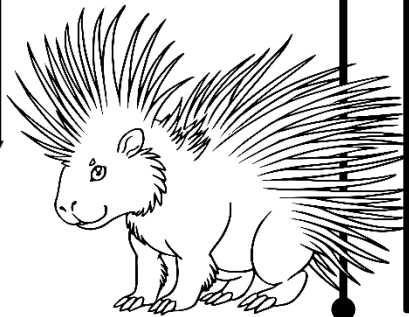
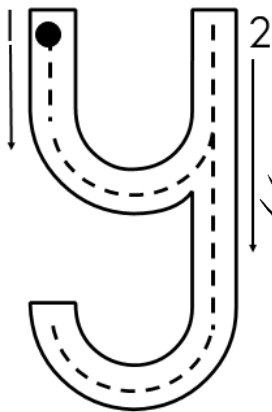

Omkring al die y-klanke.

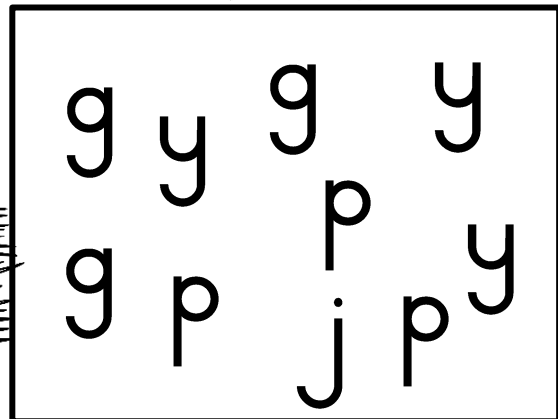

Oefen om die letter te skryf.

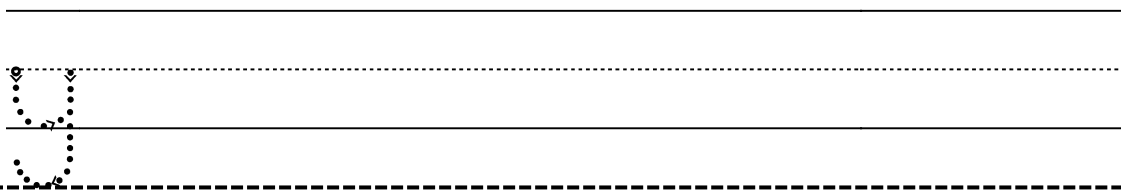

Vul die y-klanke op die regte plekke in.

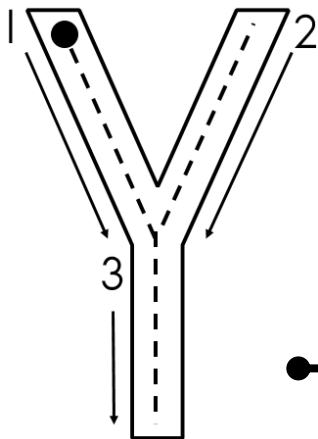

__ s

m __

__ ster

h __

Oefen om die hoofletter te skryf.

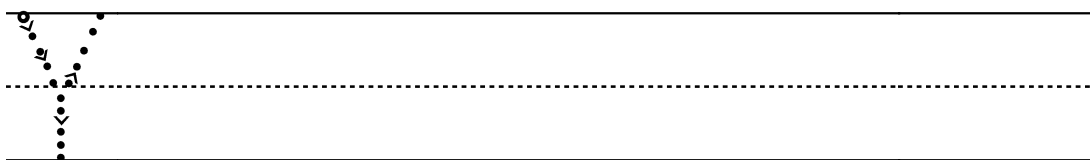

y-klank

Kleur al die prente in wat met 'n y-klank begin.

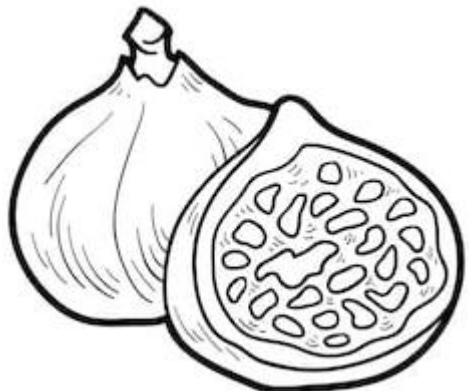
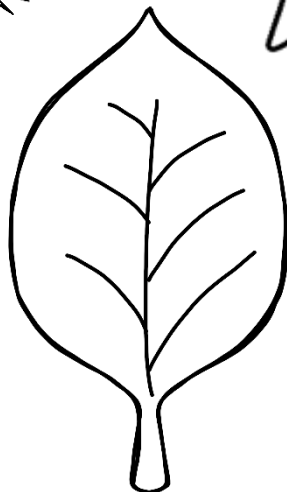
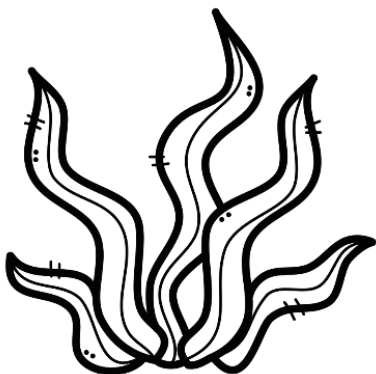
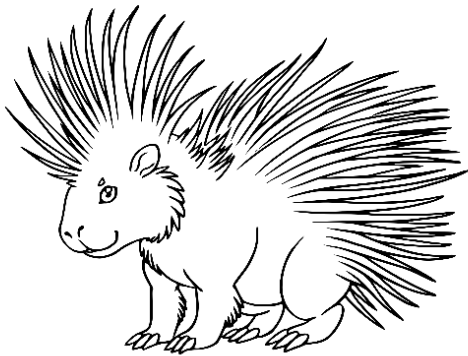
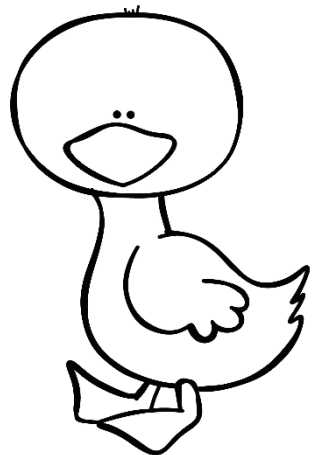
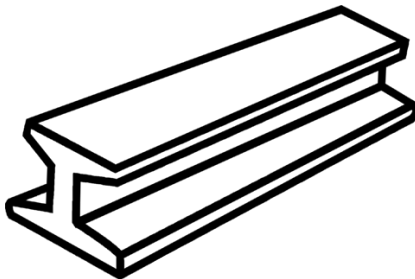
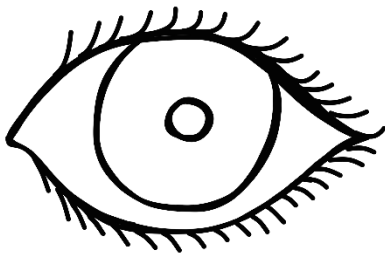
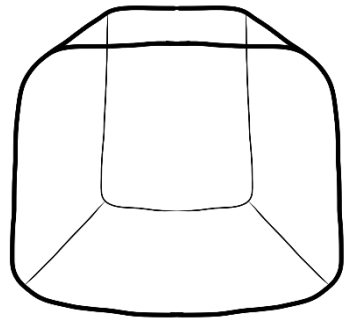
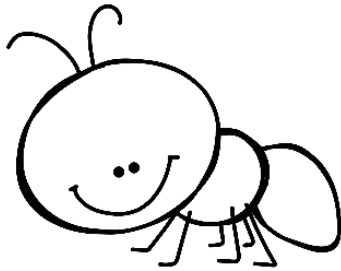
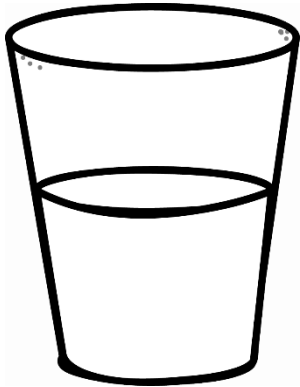

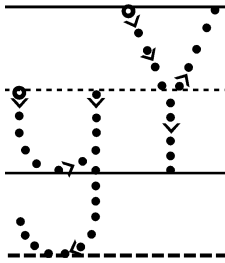
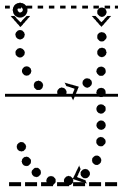
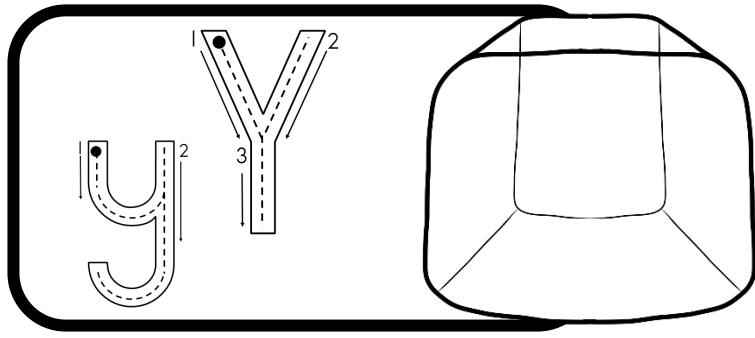

Oefen om die y-woorde te skryf.

my	my	
hy	hy	
ys	ys	
wys	wys	

kyk	kyk	
lyk	lyk	
vy	vy	
kry	kry	

Kleur die "v" in.

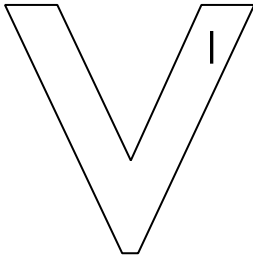

l - rooi

Lees die woorde.

vin	vyf	vol	vuur
vir	vas	veg	voor
vlug	vleg	vis	verf
vuur	vark	vlieg	venster
veter	varing	vinger	vy

Trek oor die letter.



Omkring al die v-klanke.

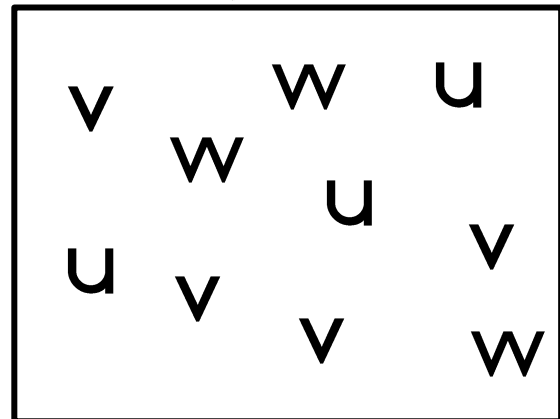

Oefen om die letter te skryf.

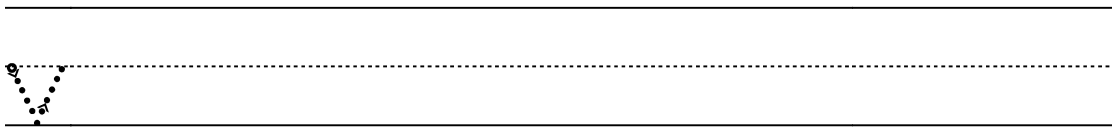

Vul die v-klanke op die regte plekke in.

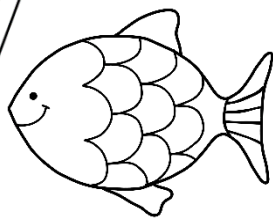
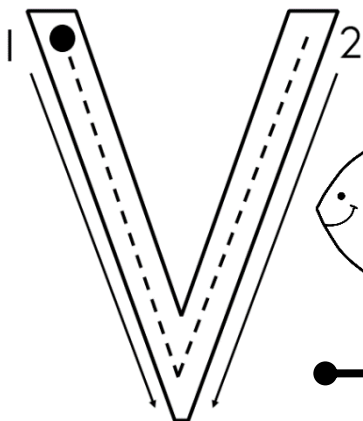

__ is | __ uur
__ in | __ ark
__ yf | __ enster
__ as | __ lieg

Oefen om die hoofletter te skryf.

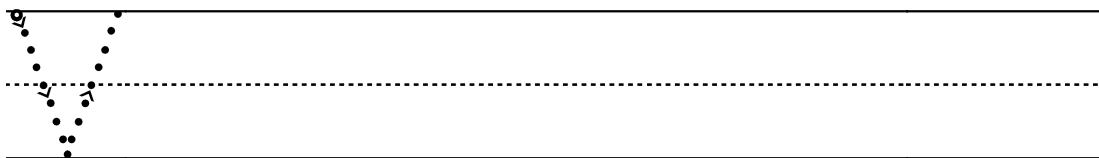

v-klank

Kleur al die prente in wat met 'n v-klank begin.

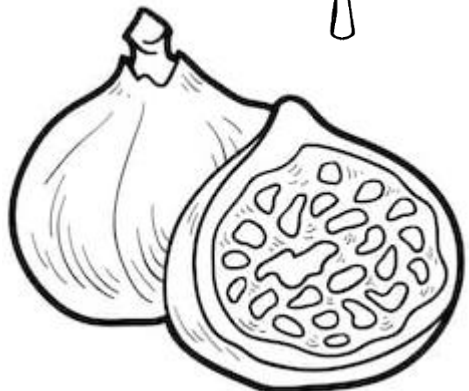
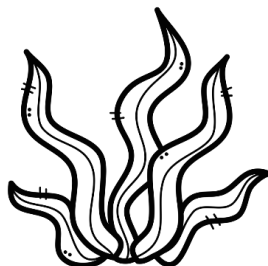
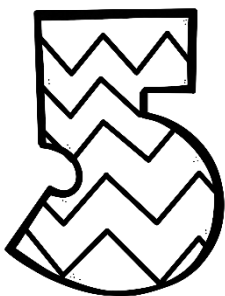
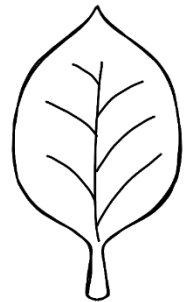
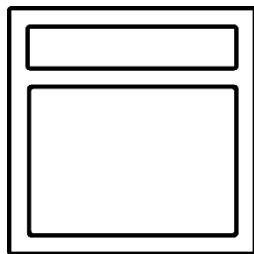
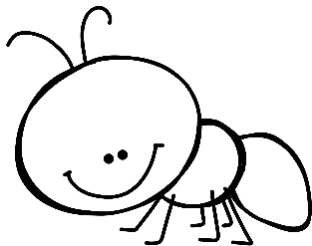
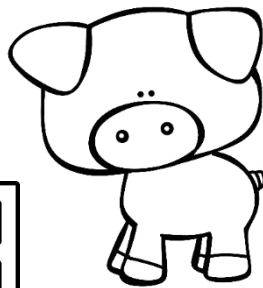
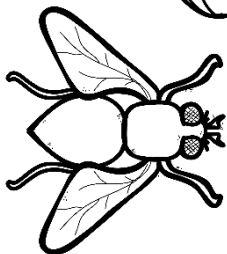
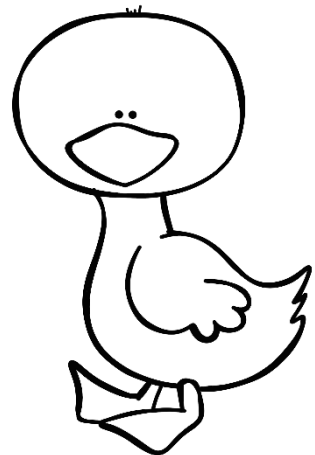
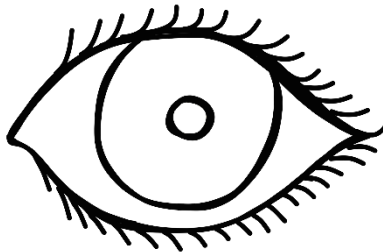
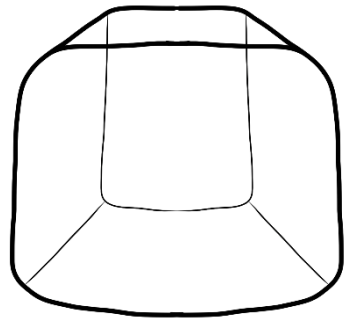
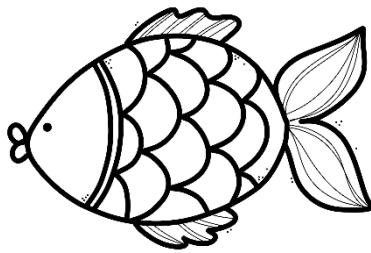
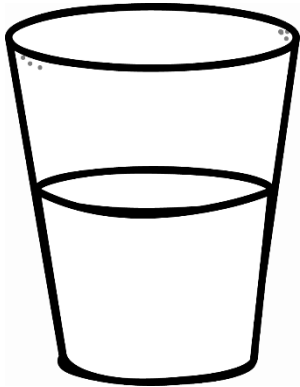

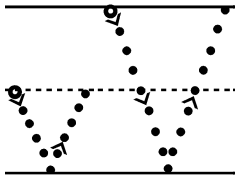
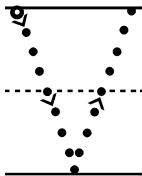
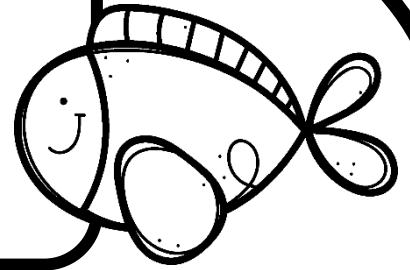
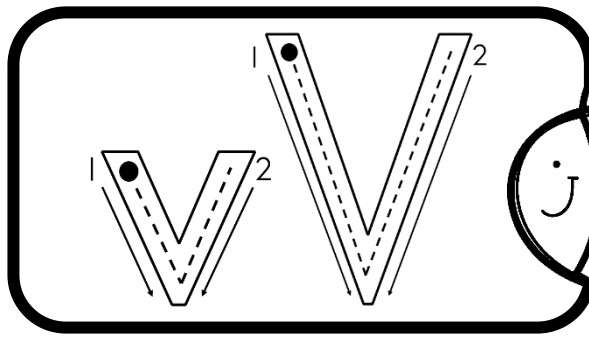

Oefen om die v-woorde te skryf.

vis	vis	
vin	vin	
vyf	vyf	
vas	vas	

vir	vir	
vol	vol	
veg	veg	
voor	voor	

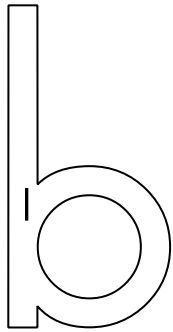

Kleur die "b" in.

l - blou

Lees die woorde.

bed	bek	byl	bus
bul	by	bal	balle
boor	bly	blou	bad
boek	beet	bak	baba
blom	ballon		

Trek oor die letter.

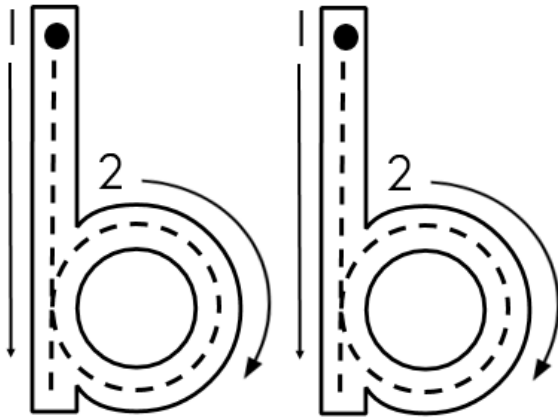

Omkring al die b-klanke.

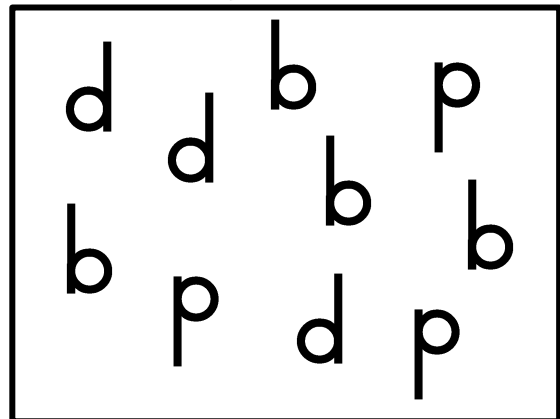

Oefen om die letter te skryf.

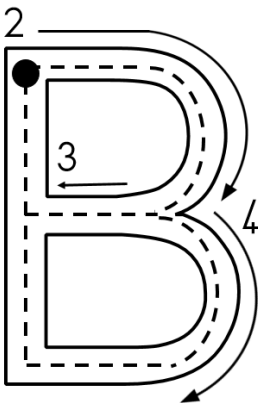
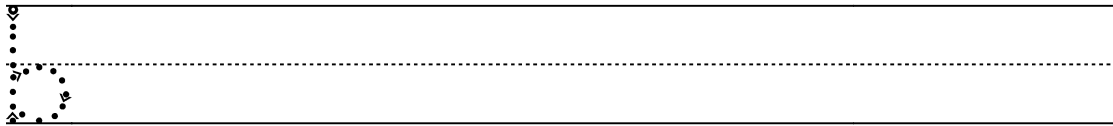

Vul die b-klanke op die regte plekke in.

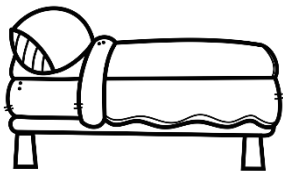

__y	__ek	__eet
__ed	__ul	__oek
__ad	__yl	__a__a
__al	__lou	__lom

Oefen om die hoofletter te skryf.

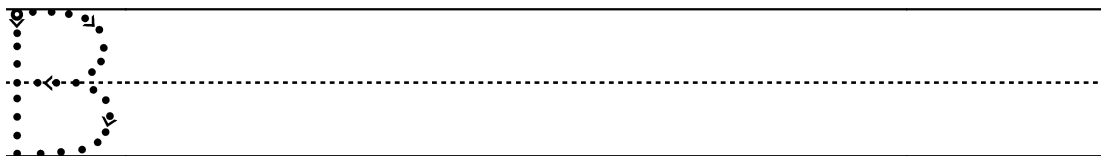

b-klank

Kleur al die prente in wat met 'n b-klank begin.

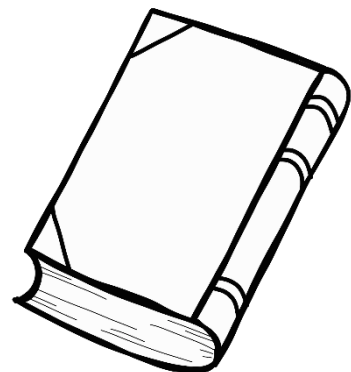
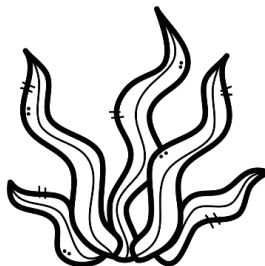
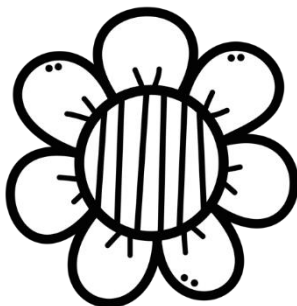
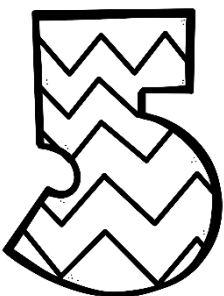
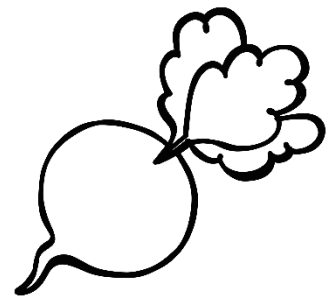
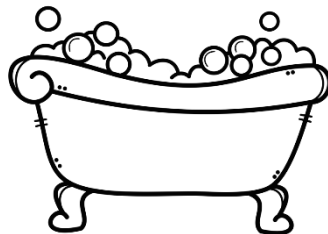
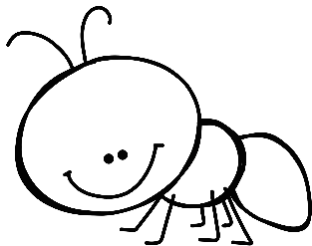
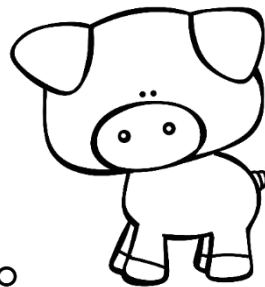
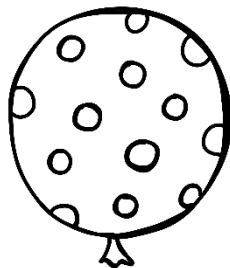
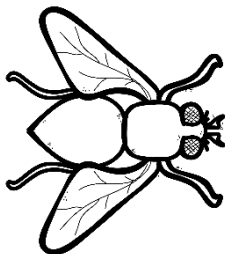
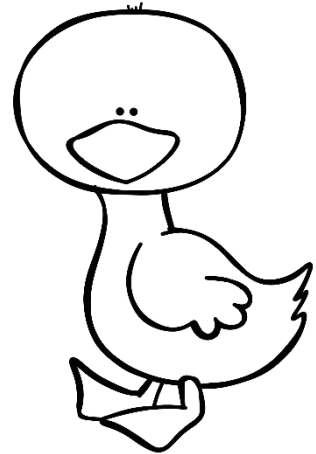
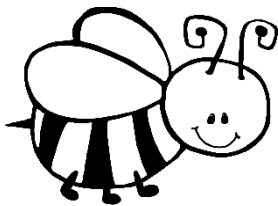
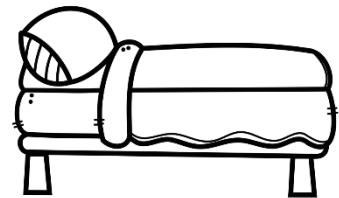
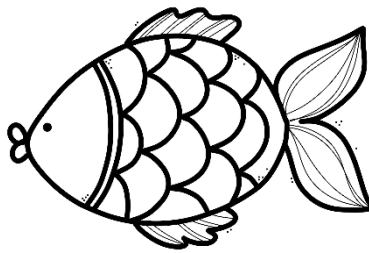
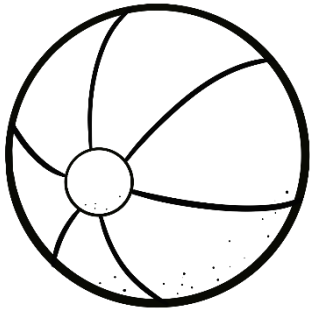

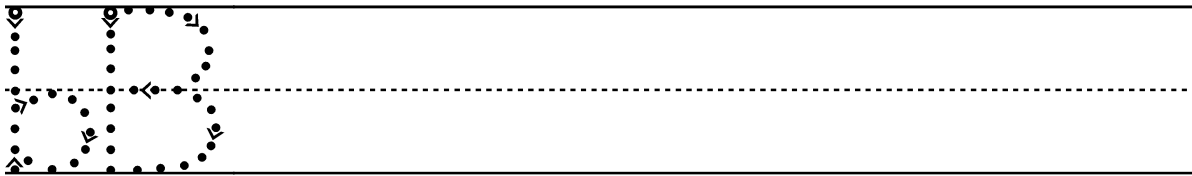
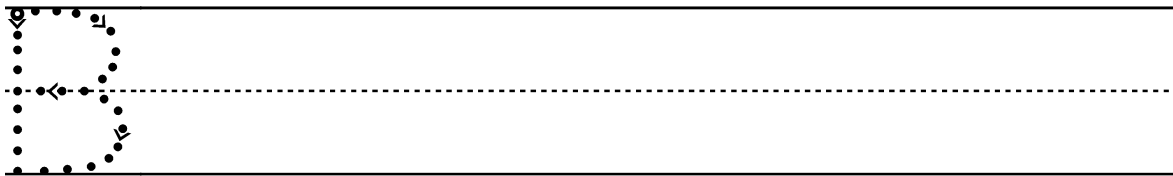
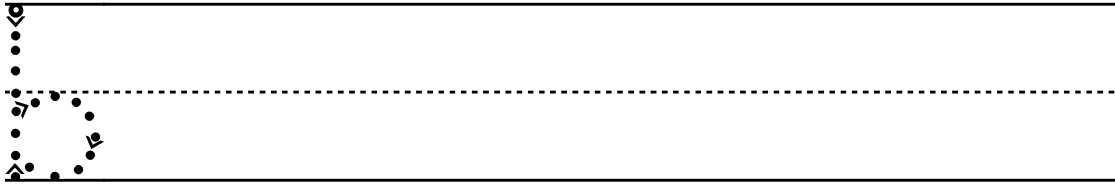
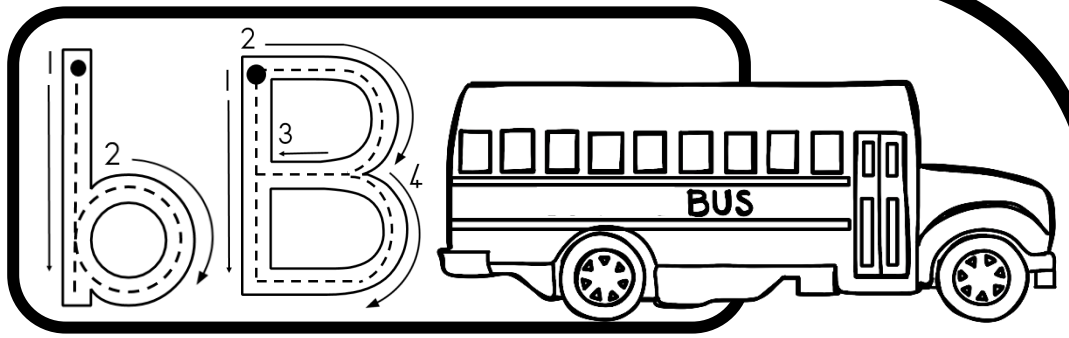

Oefen om die b-woorde te skryf.

bad	bad	
bed	bed	
bal	bal	
bu	bu	

by	by	
bly	bly	
bek	bek	
boek	boek	

Kleur die "e" in.

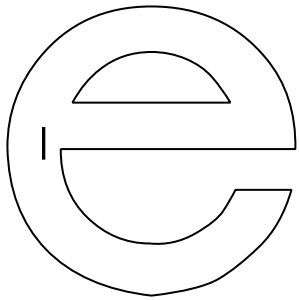

l - geel

Lees die woorde.

elf	ent	en	ek
ertjies	emmer	endwurm	

Woorde met "e" as middelklank.

ses	les	stem	pret	pen
hen	bed	hek	nes	net

Trek oor die letter.

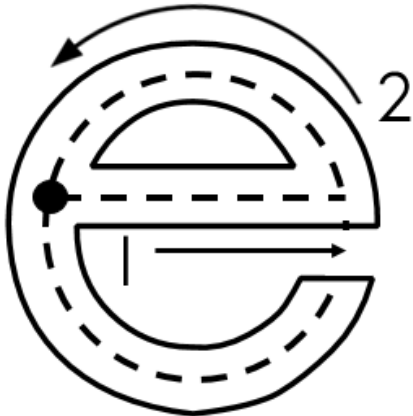

Omkring al die e-klanke.

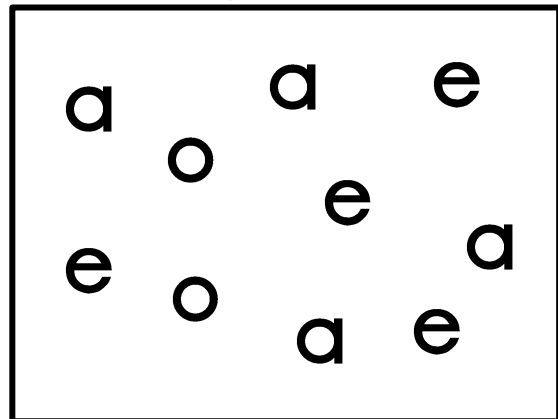

Oefen om die letter te skryf.

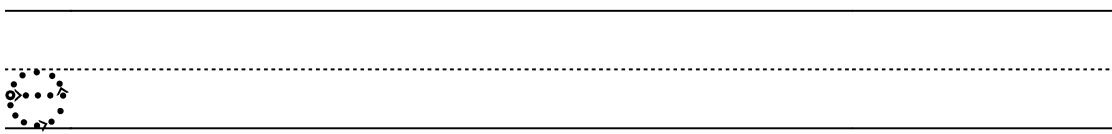

Vul die e-klanke op die regte plekke in.

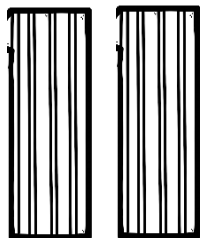
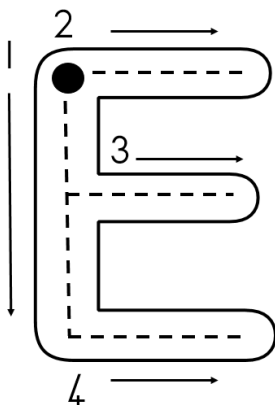

__n		s__s		l__s
__k		n__s		st__m
__lf		h__n		pr__t
__nt		n__t		p__n

Oefen om die hoofletter te skryf.

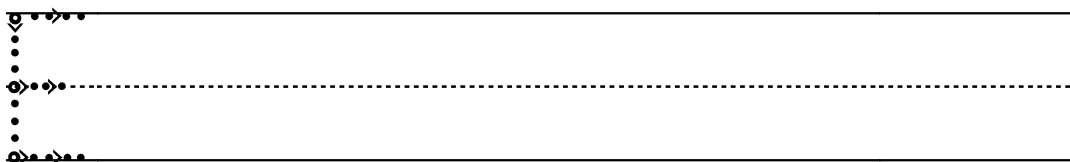

e-klank

Kleur al die prente in wat met 'n e-klank begin.

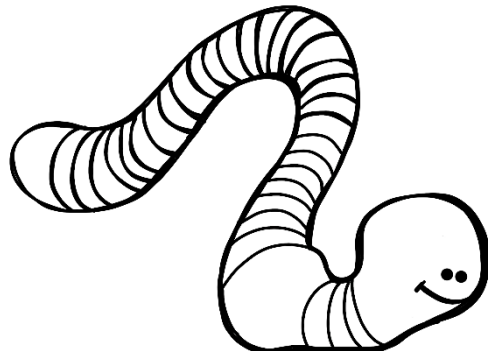
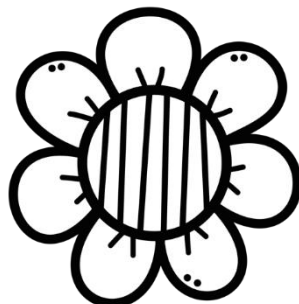
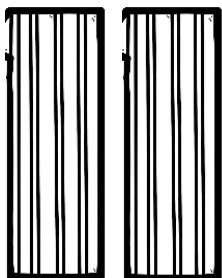
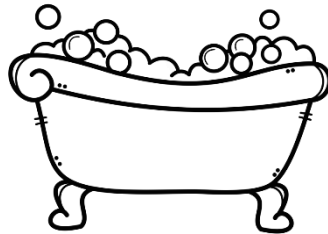
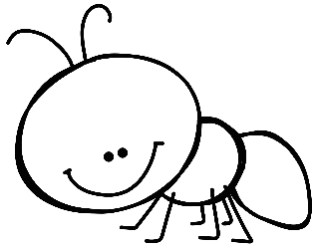
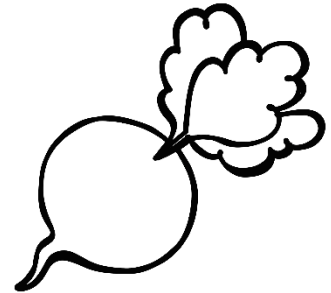
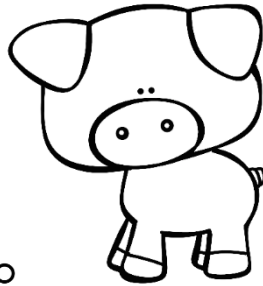
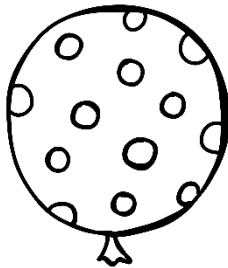
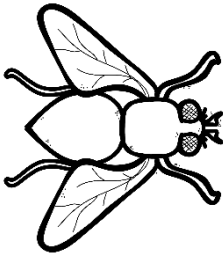
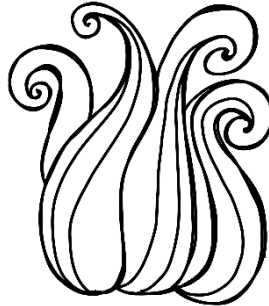
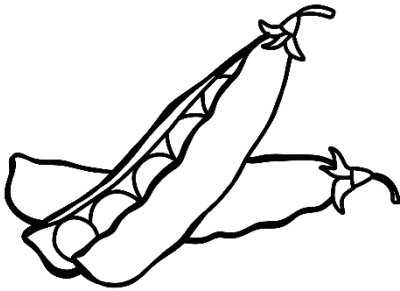
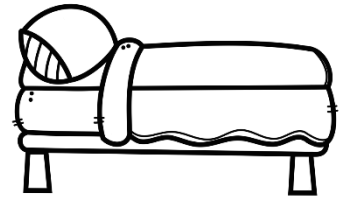
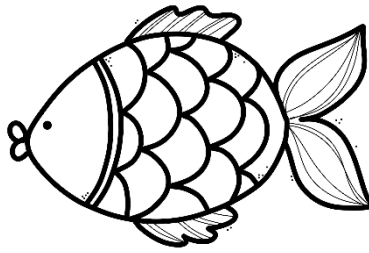
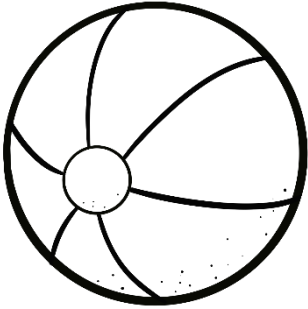

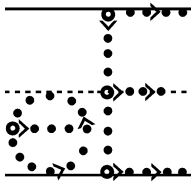
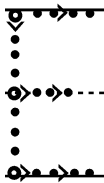
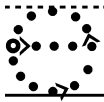
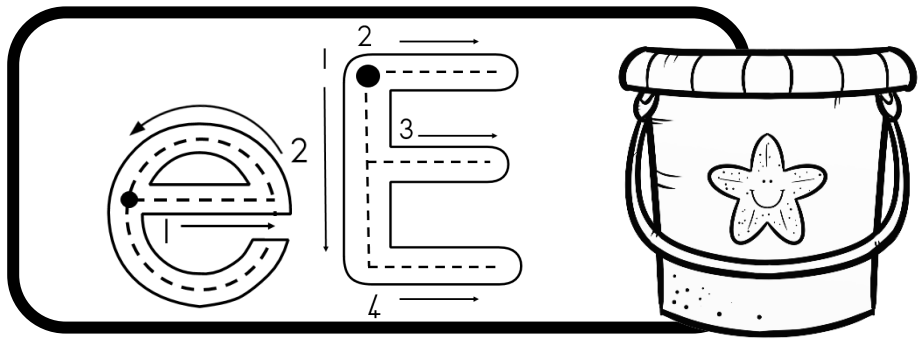



Oefen om die e-woorde te skryf.

ek	ek	
en	en	
elf	elf	
ent	ent	

ees	ees	
nes	nes	
net	net	
hen	hen	

e-klank

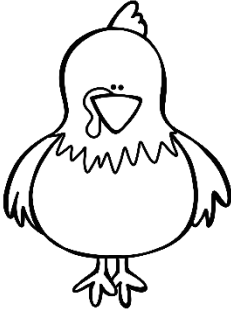
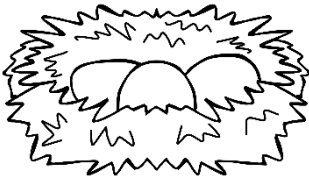
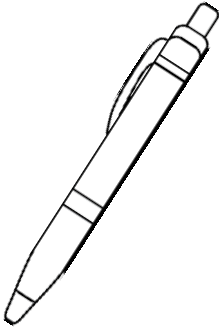
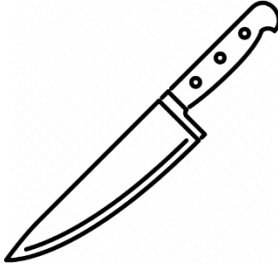
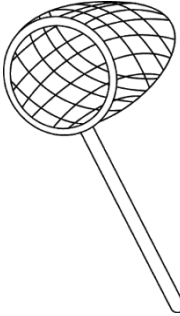
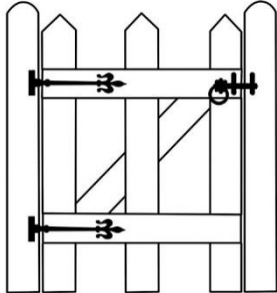
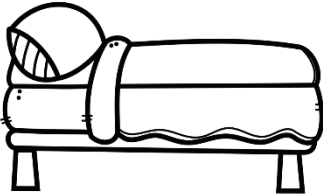
Skryf die woord vir elke prent en onderstreep die e-klank.

Kleur die "r" in.

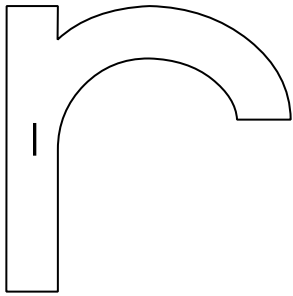

l - pers

Lees die woorde.

rug	rek	rak	rits
reg	ryk	rok	rots
raam	roos	reën	rooi
rot	rissie	radio	roomys
reënboog			

Trek oor die letter.

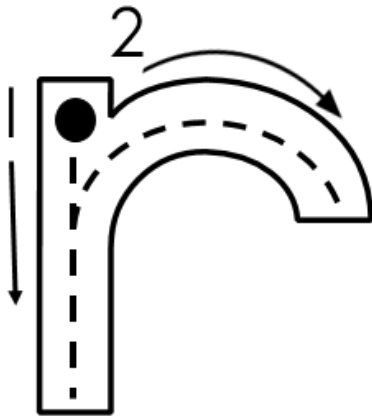

Omkring al die r-klanke.

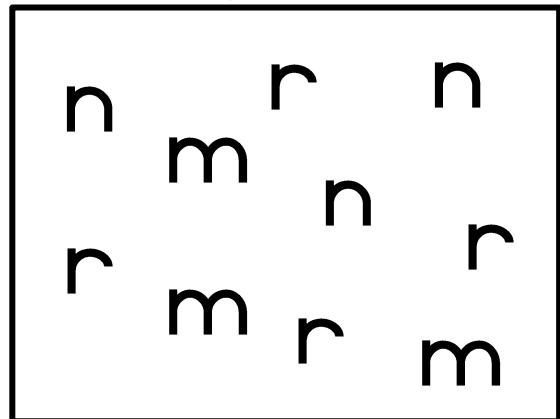

Oefen om die letter te skryf.

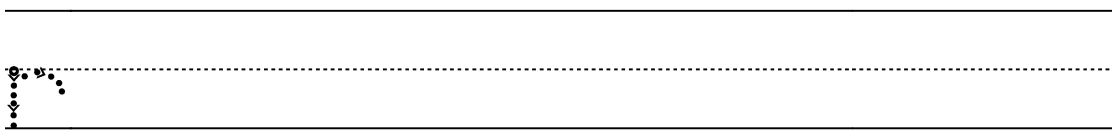

Vul die r-klanke op die regte plekke in.

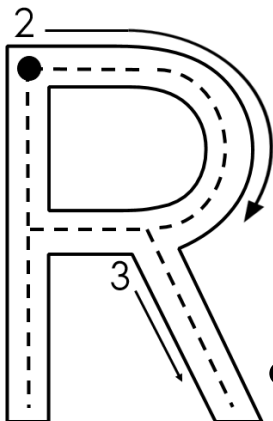

__ug	! __yk	! __oos
__eg	! __ot	! __ots
__ek	! __its	! __aam
__ok	! __eën!	! __ooi

Oefen om die hoofletter te skryf.

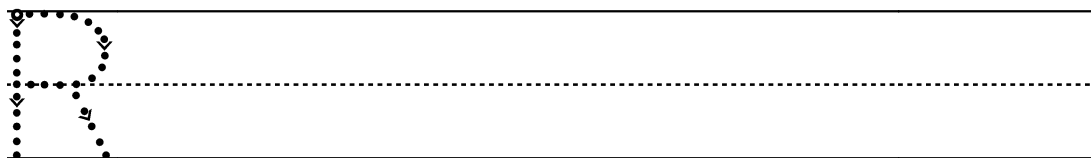

r-klank

Kleur al die prente in wat met 'n r-klank begin.

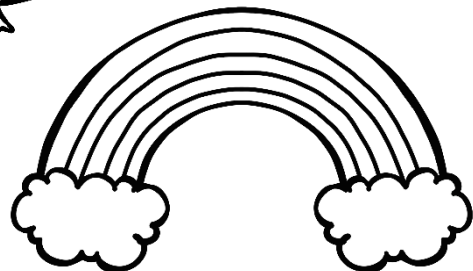
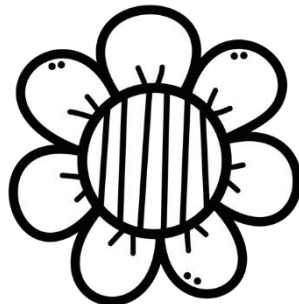
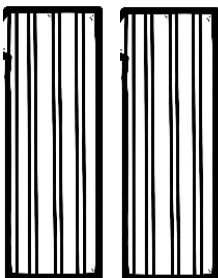
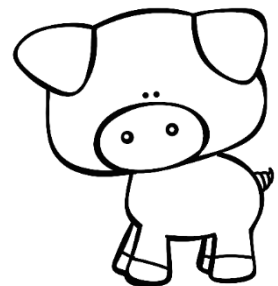
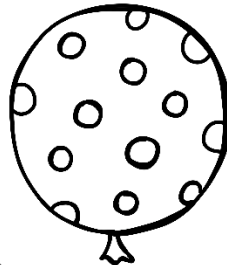
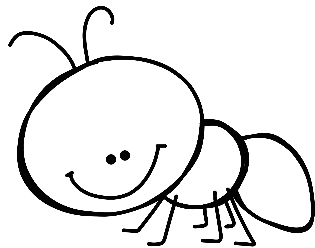
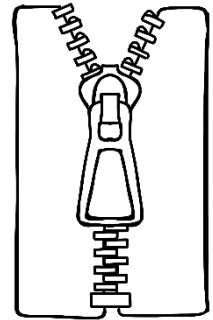
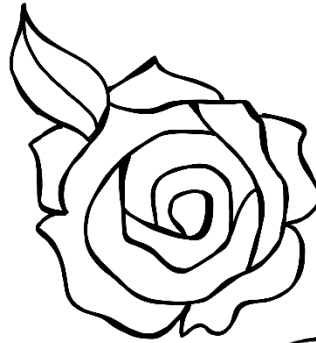
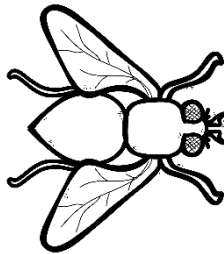
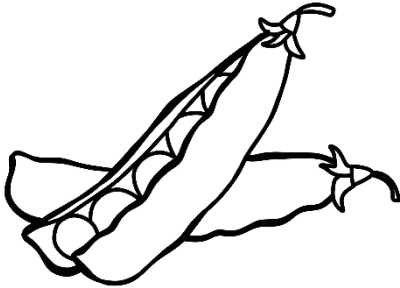
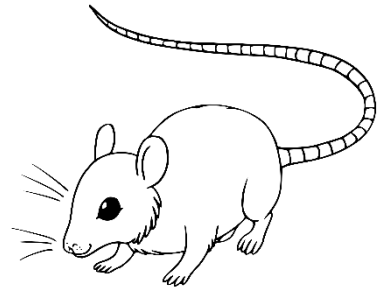
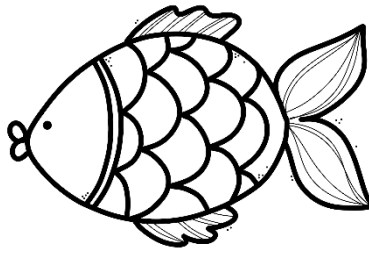

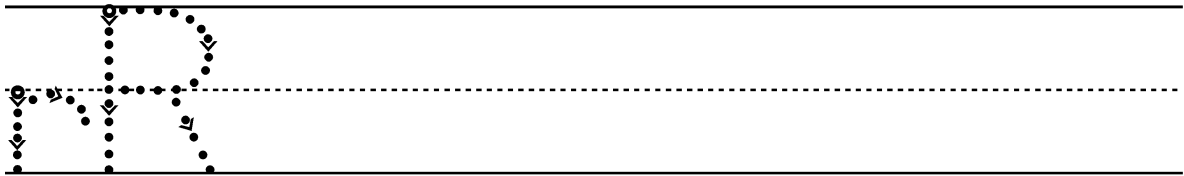
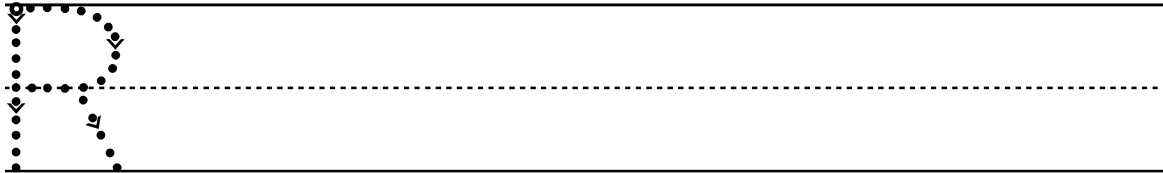
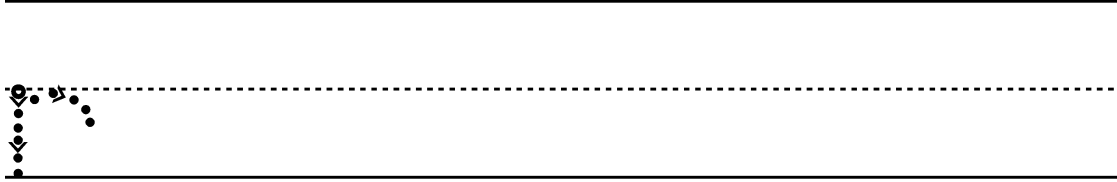
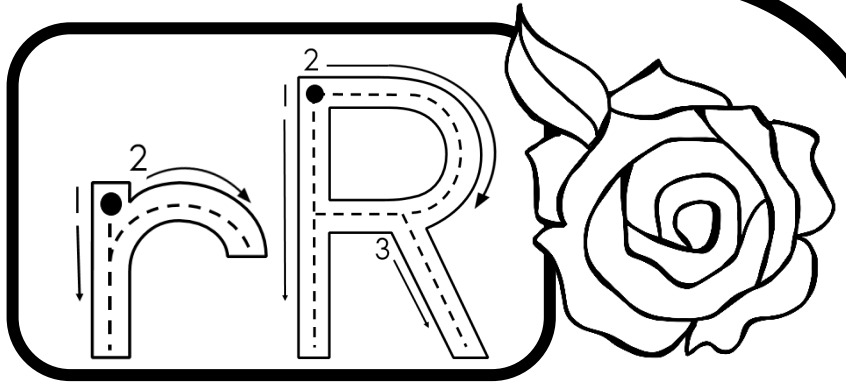

Oefen om die r-woorde te skryf.

rug	rug	
reg	reg	
rok	rok	
rot	rot	

rek	rek	
ryg	ryg	
rots	rots	
rits	rits	

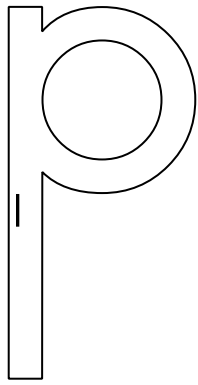

Kleur die "p" in.

l - pienk

Lees die woorde.

pop	pik	pil	pyn
pak	pas	pyl	pos
poot	pad	plek	pen
pap	put	pan	piesang
potlood	pampoens	peer	prop

Trek oor die letter.

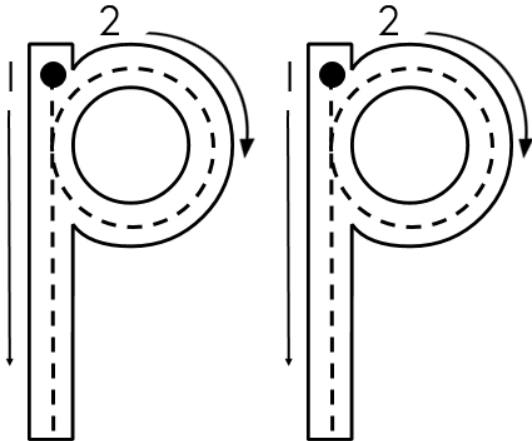

Omkring al die p-klanke.

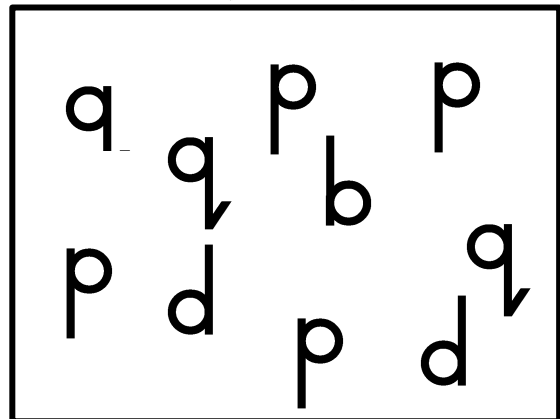

Oefen om die letter te skryf.

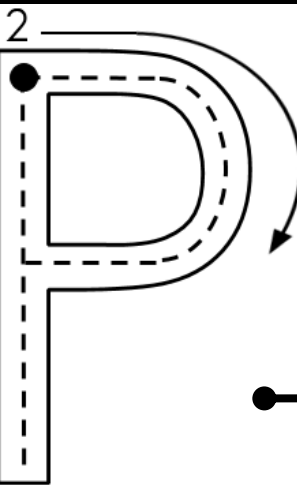
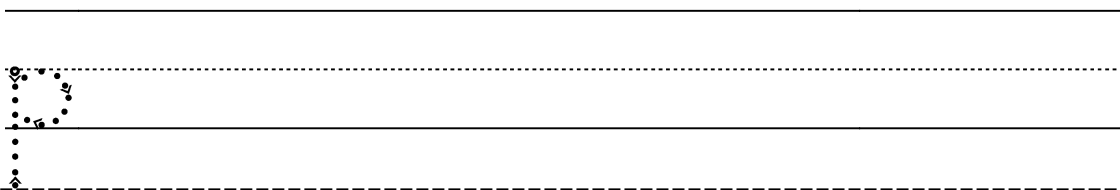

Vul die p-klanke op die regte plekke in.

__op	! __ik	! __oot
__ak	! __yl	! __lek
__ot	! __ad	! __il
__ap	! __en	! __os

Oefen om die hoofletter te skryf.

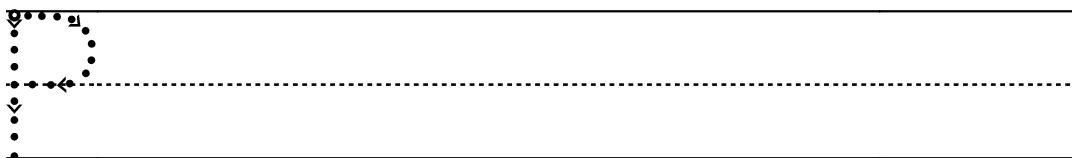

p-klank

Kleur al die prente in wat met 'n p-klank begin.

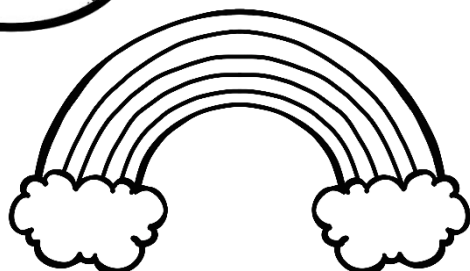
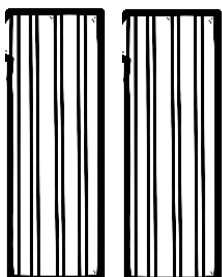
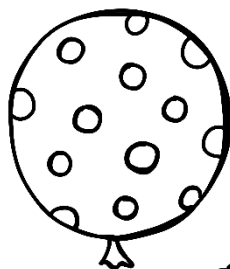
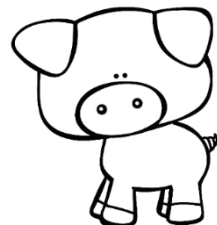
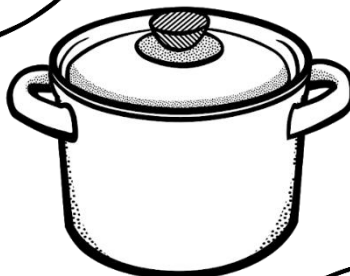
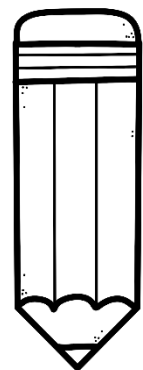
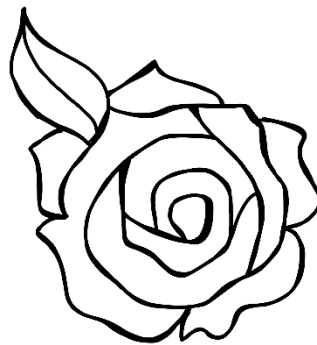
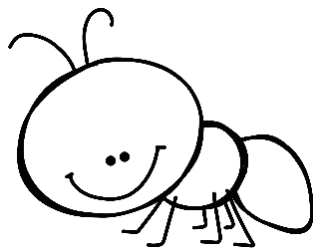
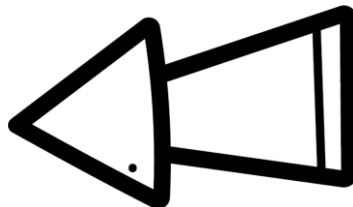
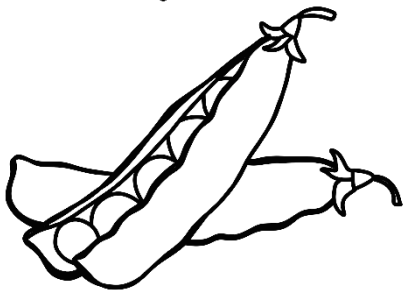
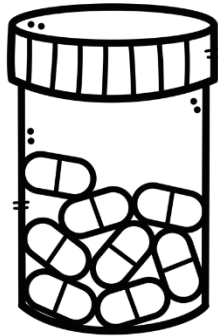

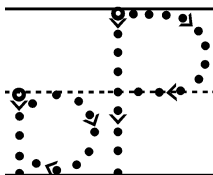
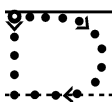
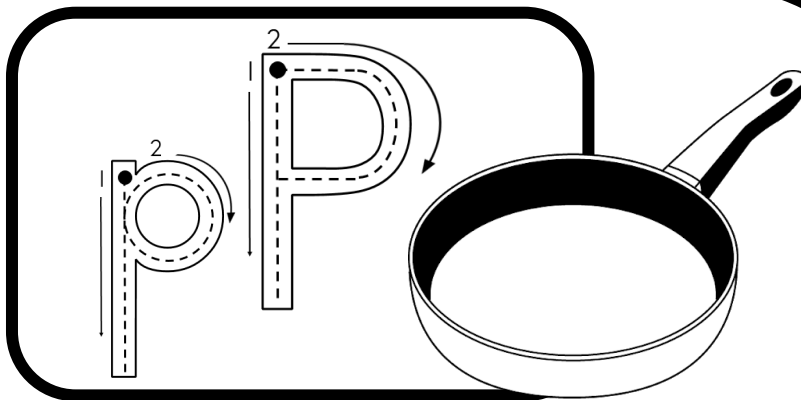

Oefen om die p-woorde te skryf.

pot	pot	
pan	pan	
pop	pop	
pen	pen	

pyl	pyl	
pos	pos	
pad	pad	
pin	pin	

Kleur die "m" in.

l - rooi

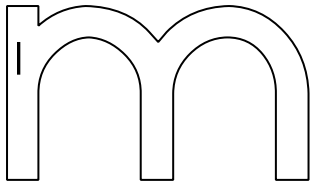

Lees die woorde.

man	mes	mos	mus
mat	met	mol	mou
ma	maag	melk	maan
mond	muis		

Trek oor die letter.

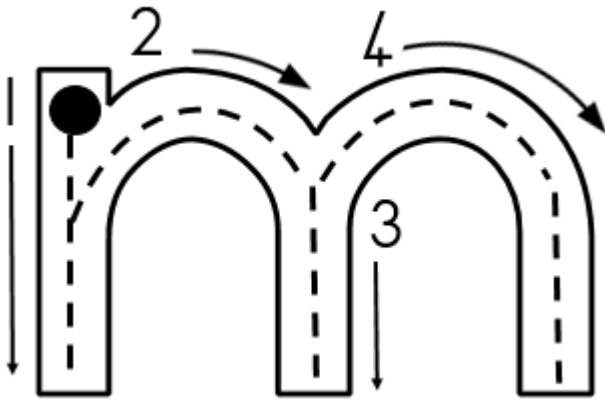

Omkring al die m-klanke.

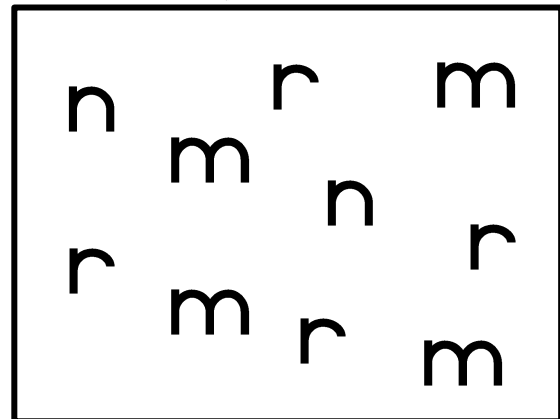

Oefen om die letter te skryf.

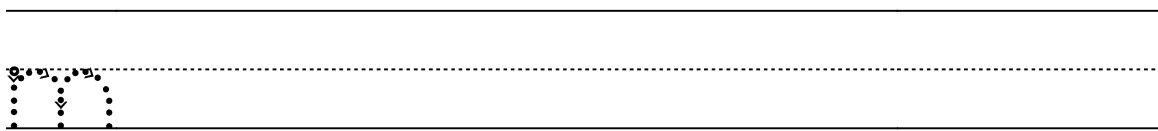

Vul die m-klanke op die regte plekke in.

__at	! __us	! __aag
__an	! __ol	! __elk
__es	! __ou	! __aan
__os	! __et	! __uis



Oefen om die hoofletter te skryf.

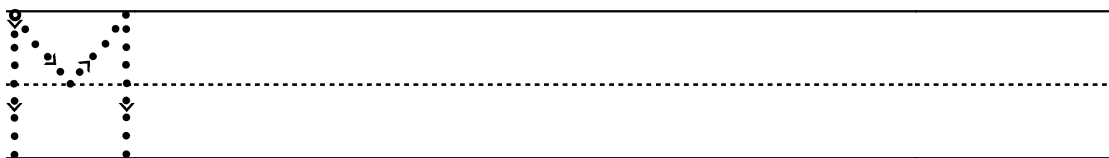

m-klank

Kleur al die prente in wat met 'n m-klank begin.

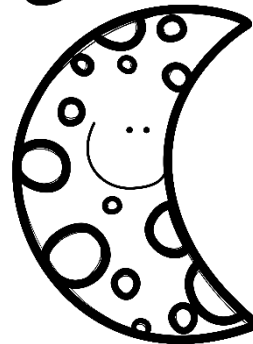
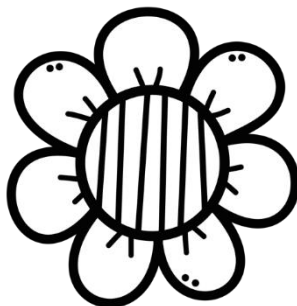
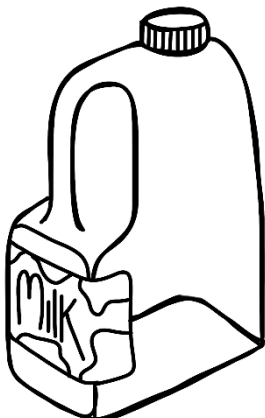
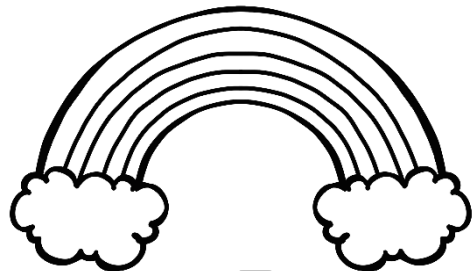
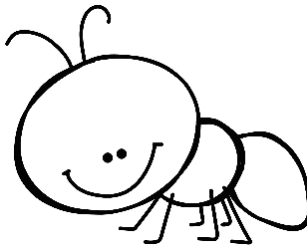
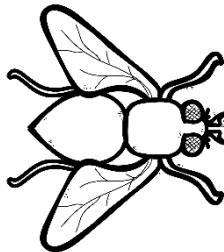
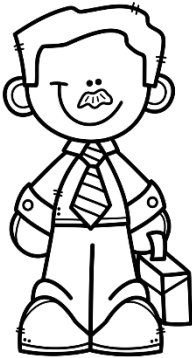
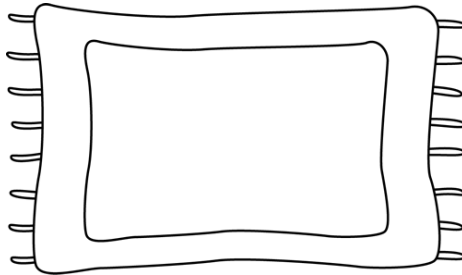
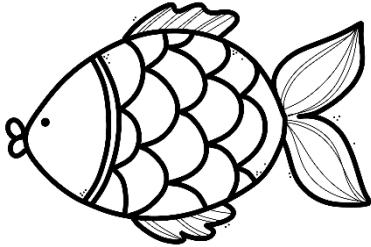
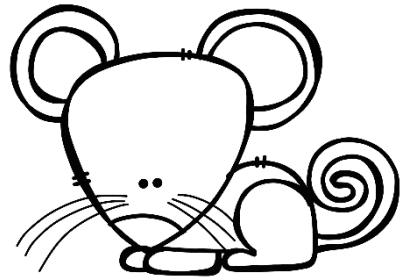
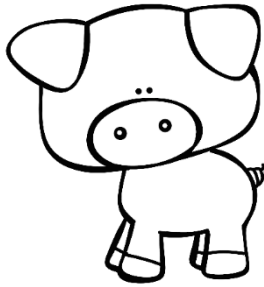

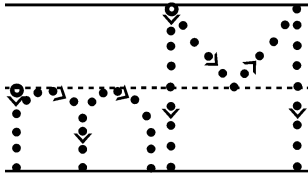
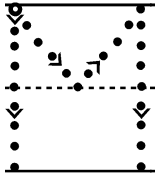
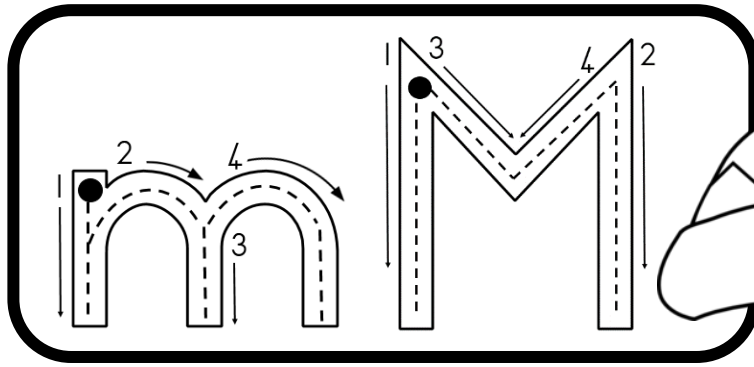

Oefen om die m-woorde te skryf.

ma	ma	
man	man	
mat	mat	
mol	mol	

mes	mes	
mos	mos	
mou	mou	
mus	mus	

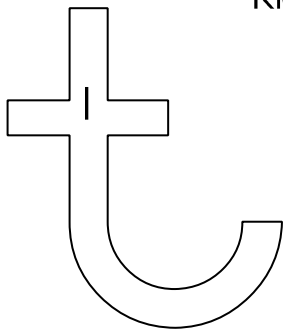

Kleur die "t" in.

1 - oranje

Lees die woorde.

tor	tel	tyd	tol
tak	tas	toor	tent
toon	tier	trui	tee
tandeborsel	tand	tong	

Trek oor die letter.

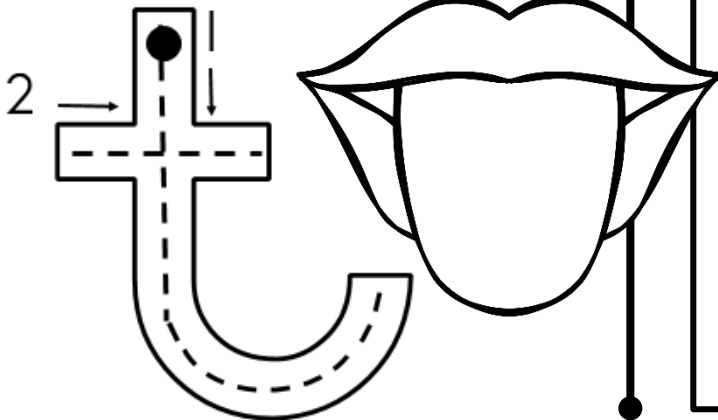

Omkring al die t-klanke.

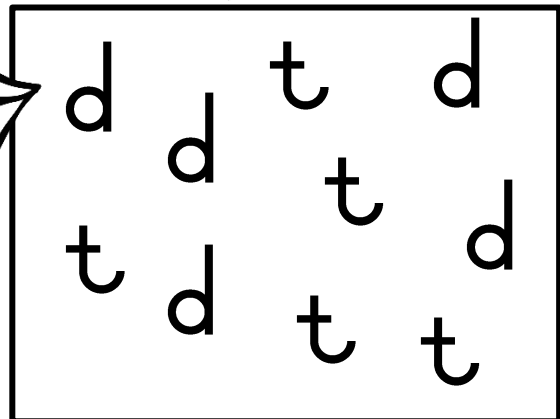

Oefen om die letter te skryf.

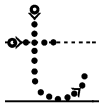

Vul die t-klanke op die regte plekke in.

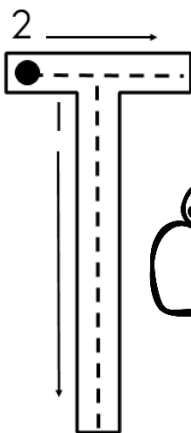

___or | ___yd | ___ier
 ___ak | ___oor | ___rui
 ___el | ___ent | ___ee
 ___as | ___oon | ___ong

Oefen om die hoofletter te skryf.

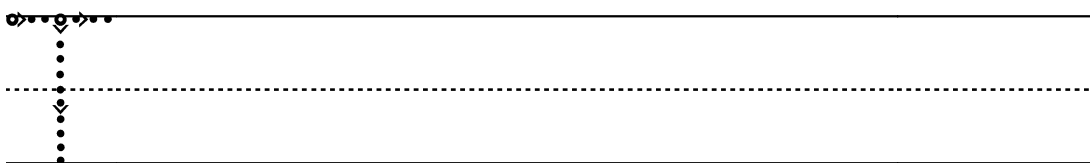

t-klank

Kleur al die prente in wat met 'n t-klank begin.

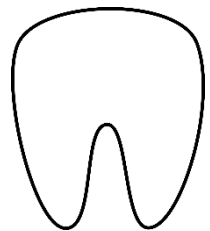
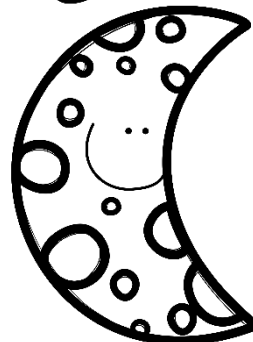
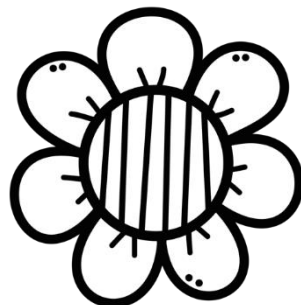
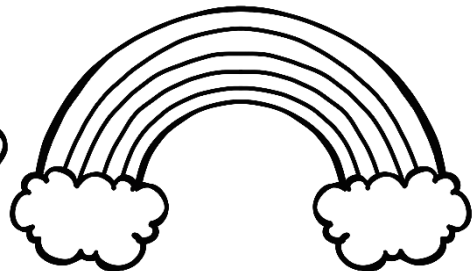
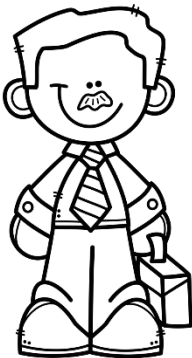
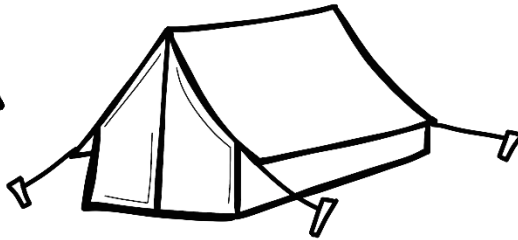
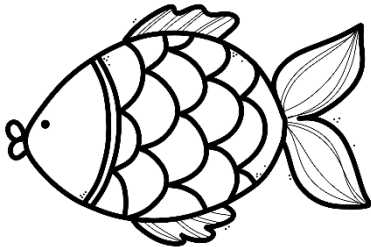
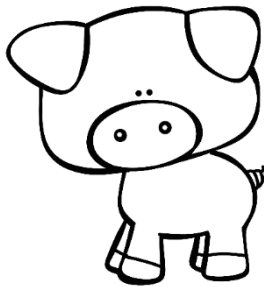
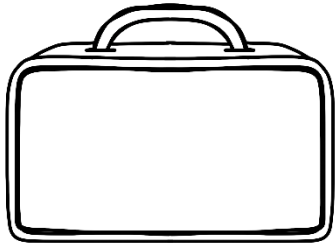

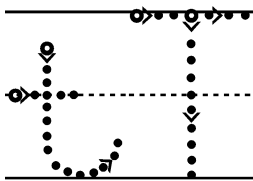
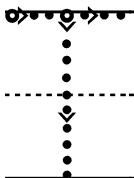
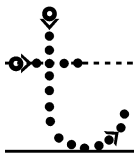
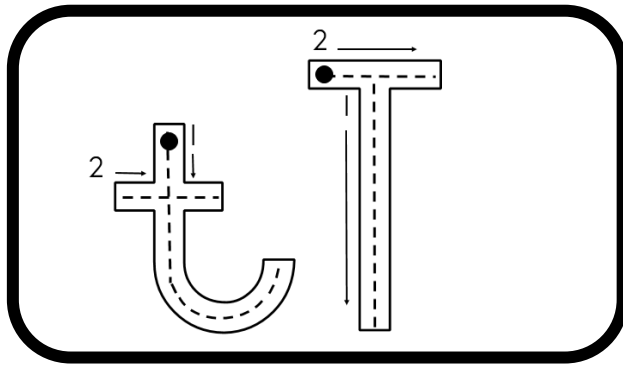

Oefen om die t-woorde te skryf.

tol	tol	
tak	tak	
tel	tel	
tyd	tyd	

tas	tas	
toon	toon	
toor	toor	
trui	trui	

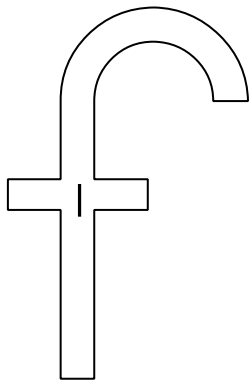

Kleur die "f" in.

l - pers

Lees die woorde.

fyn	fiks	fees	fiets
film	foto	vyf	lief
tafel	wafel	fles	fakkel
flamink		feetjie	

Trek oor die letter.

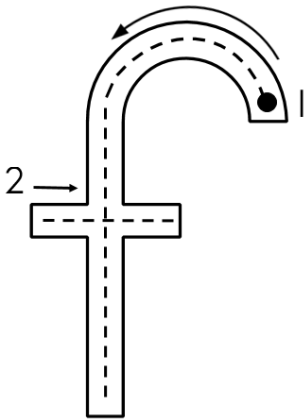

Omkring al die f-klanke.

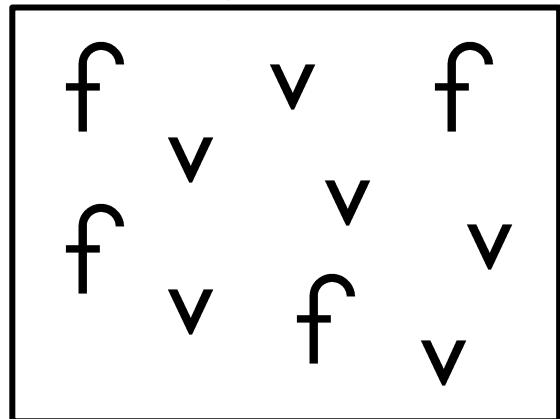

Oefen om die letter te skryf.

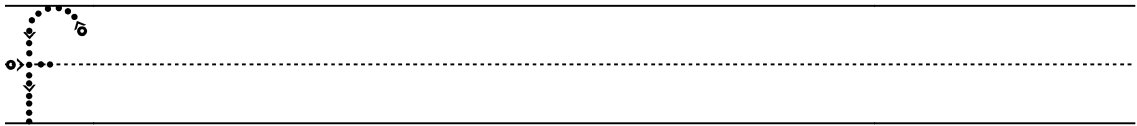

Vul die f-klanke op die regte plekke in.

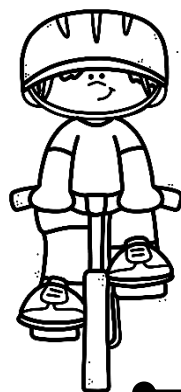
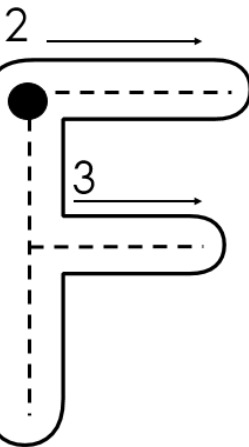

__oto	__yn	wa__el
__ees	__iks	ta__el
__iets	vy__	__les
__ilm	lie__	__akkel

Oefen om die hoofletter te skryf.

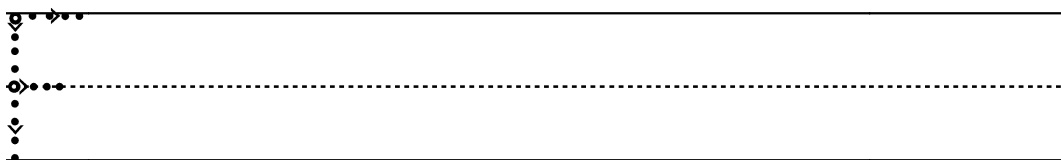

f-klank

Kleur al die prente in wat met 'n f-klank begin.

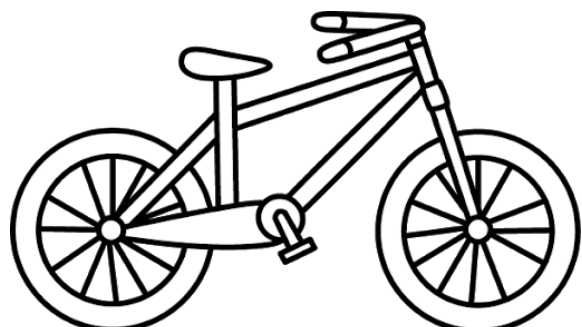
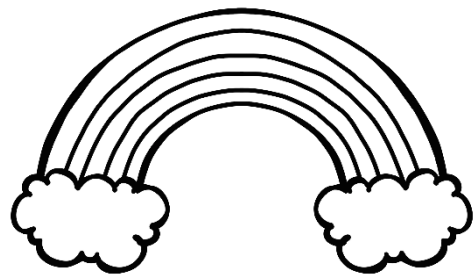
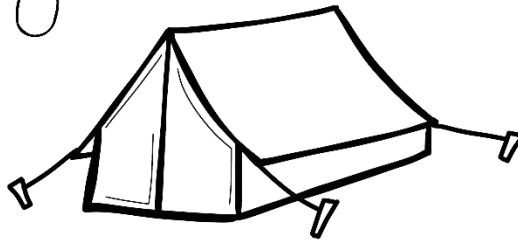
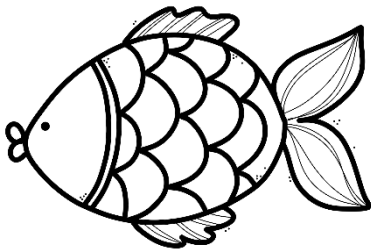
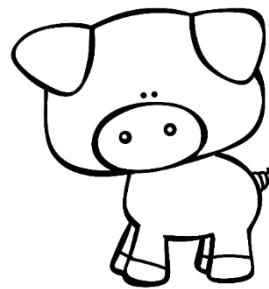
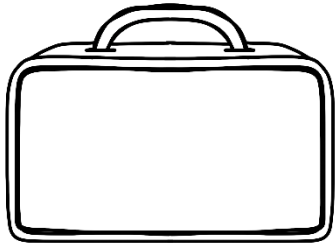

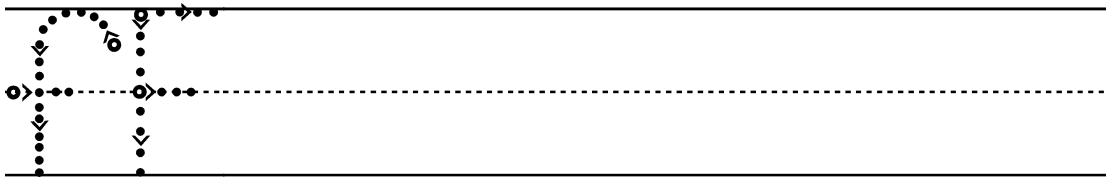
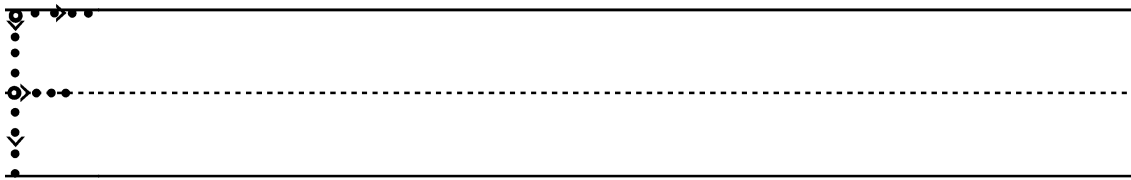
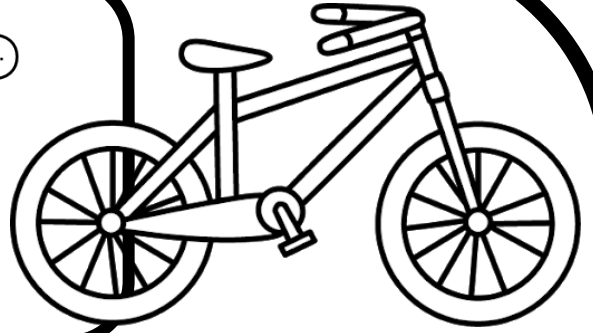
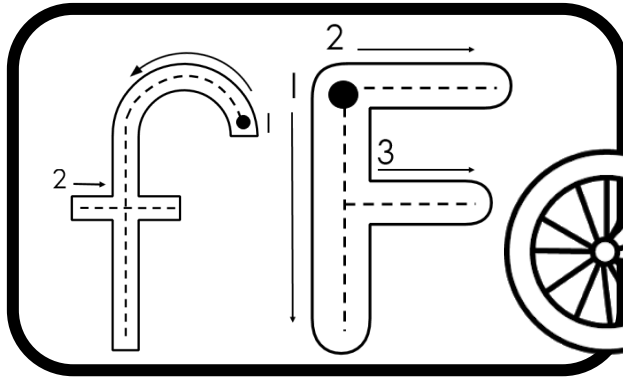

Oefen om die f-woorde te skryf.

fyn	fyn	
fees	fees	
fiets	fiets	
foto	foto	

film	film	
fiks	fiks	
fokkel	fokkel	
fles	fles	

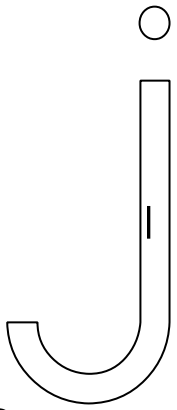

Kleur die "j" in.

! - geel

Lees die woorde.

jy	jou	julle	jellie
jas	jok	jeuk	jag
jaar	juffrou	jubbel	jammer
joghurt		jakkals	jagter

Trek oor die letter.



Omkring al die j-klanke.

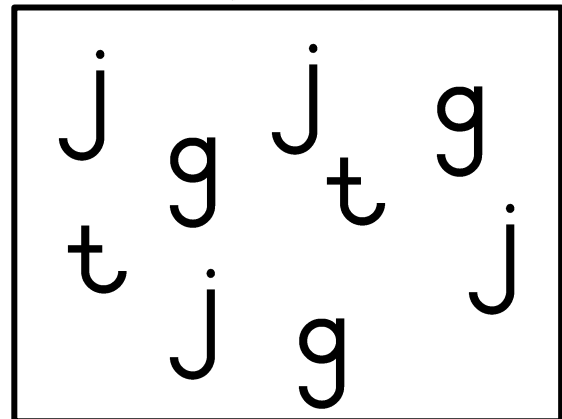

Oefen om die letter te skryf.

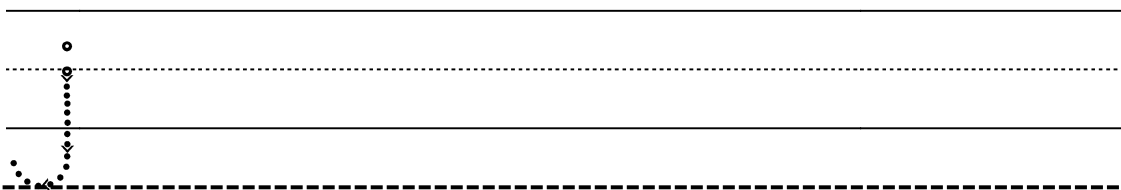

Vul die j-klanke op die regte plekke in.

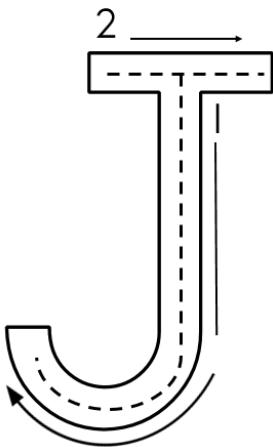

__as	! __ag	! __akkals
__ok	! __ellie	! __ammer
__ulle	! __ou	! __ubbel
__euk	! __aar	! __uffrou

Oefen om die hoofletter te skryf.

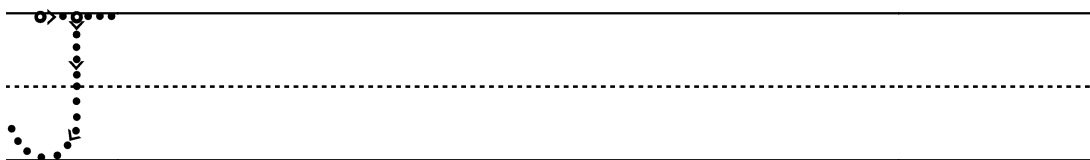

j-klank

Kleur al die prente in wat met 'n j-klank begin.

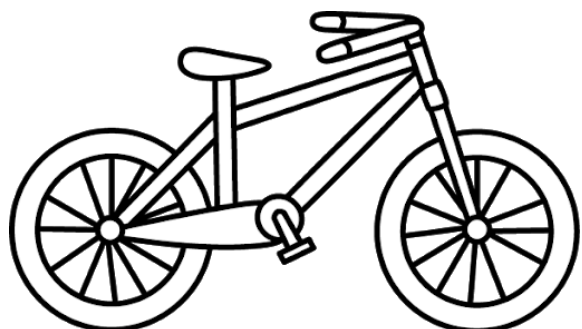
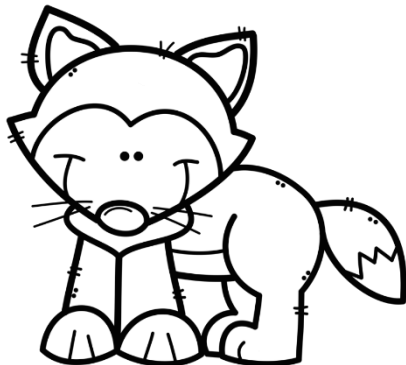
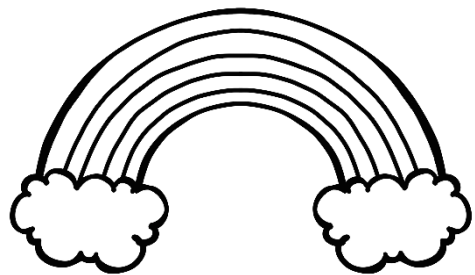
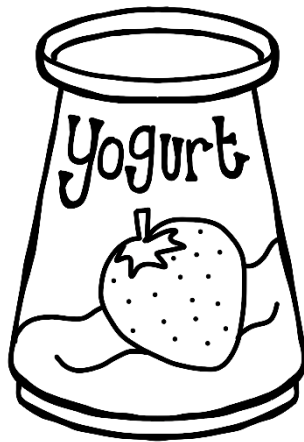
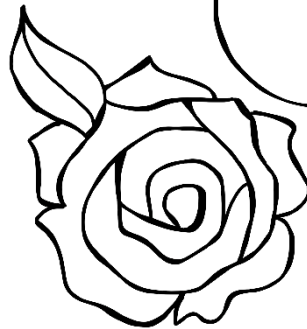
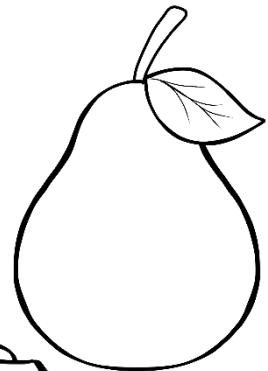
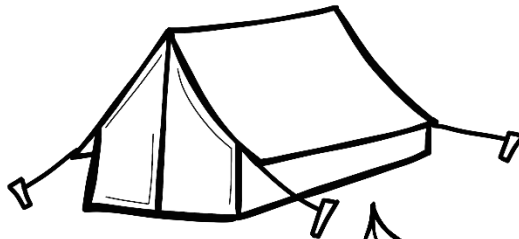
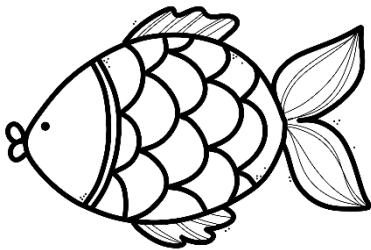
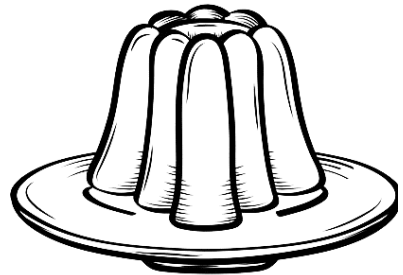
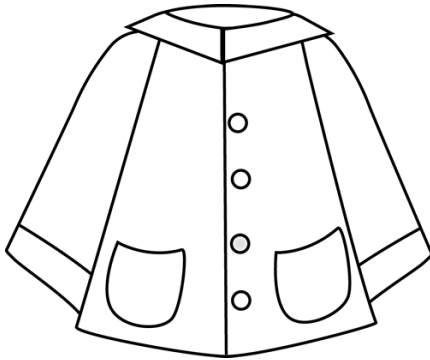
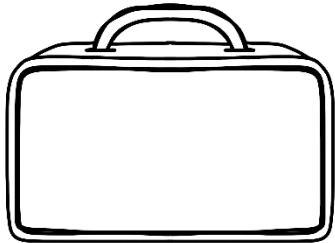

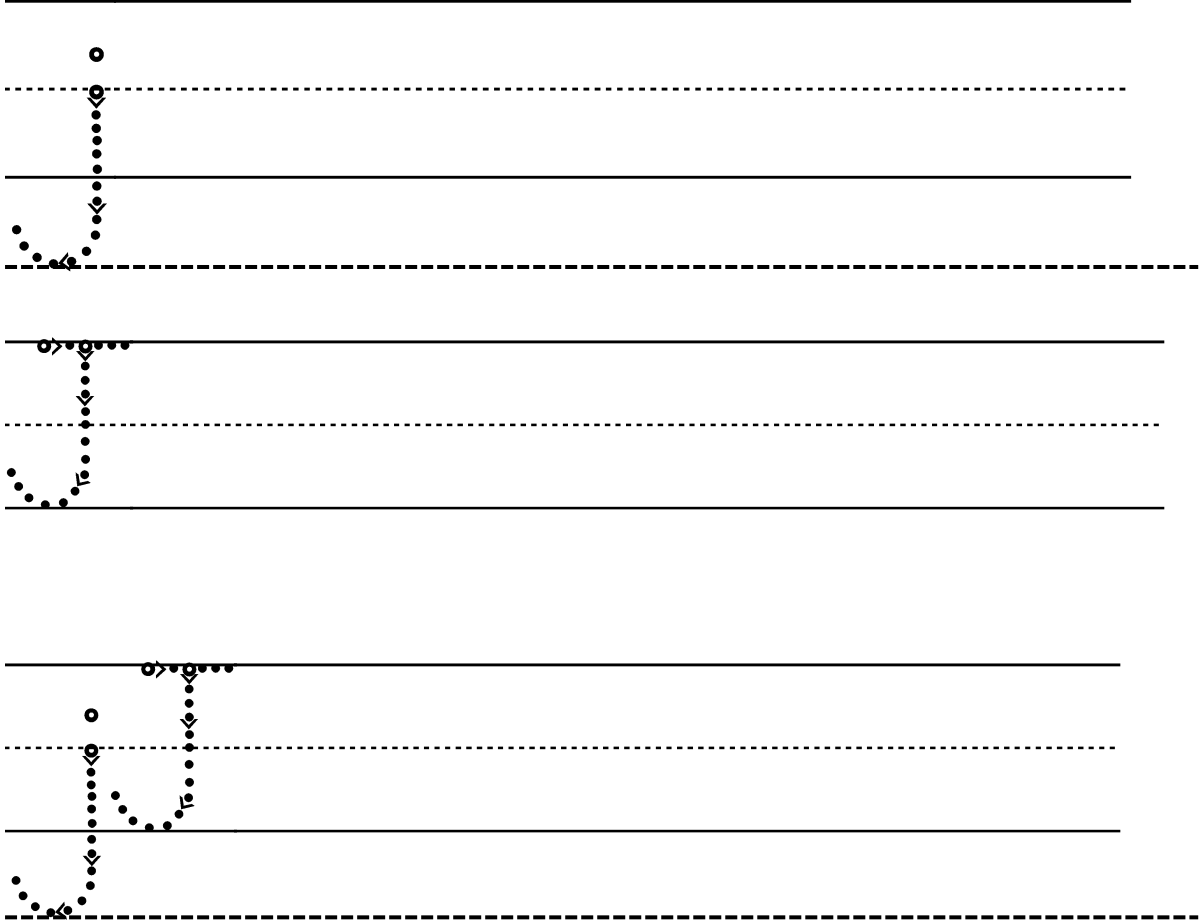
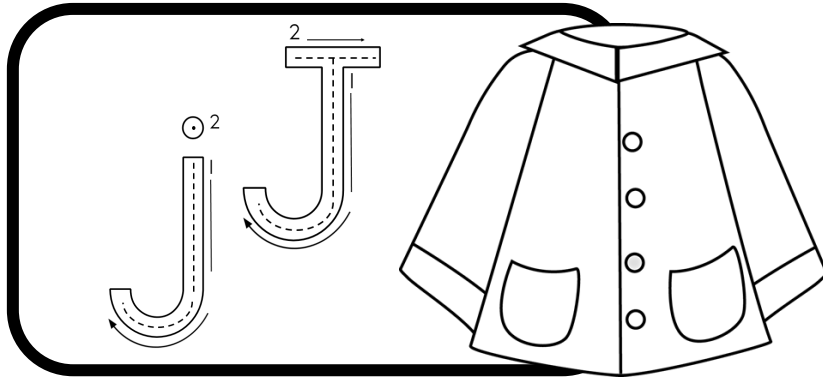

Oefen om die j-woorde te skryf.

jou	jou	
jas	jas	
jok	jok	
jeuk	jeuk	

julle	julle	
jelle	jelle	
jag	jag	
jaar	jaar	

Kleur die "n" in.

! - groen

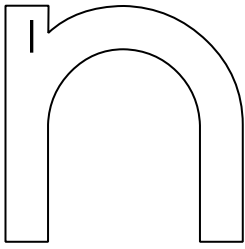

Lees die woorde.

nege	nog	nes	nuus
nee	nag	nar	nuut
na	nooit	neut	neus
nek	net	nat	nommers

Trek oor die letter.

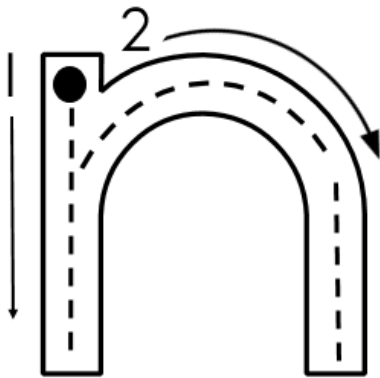

Omkring al die n-klanke.

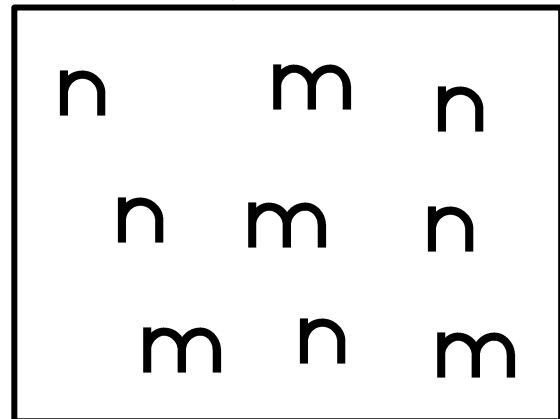

Oefen om die letter te skryf.

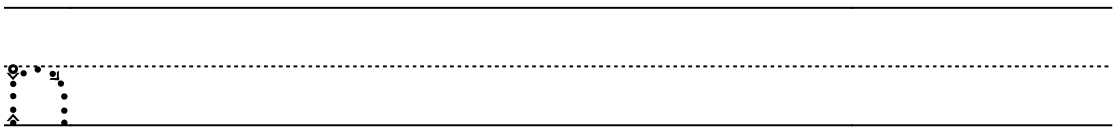

Vul die n-klanke op die regte plekke in.

__ege | __ag | __ooit
__ee | __og | __eut
__et | __es | __uus
__ek | __eus | __uut

Oefen om die hoofletter te skryf.

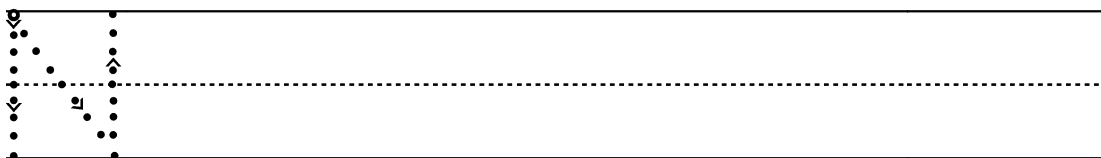

n-klank

Kleur al die prente in wat met 'n n-klank begin.

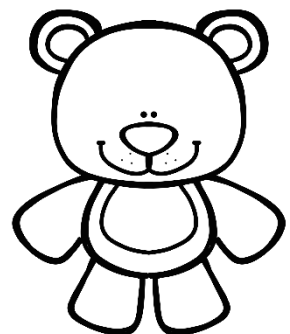
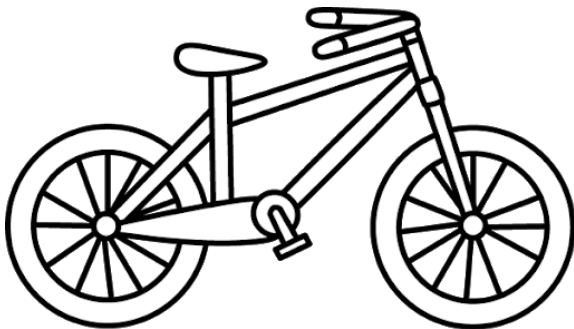
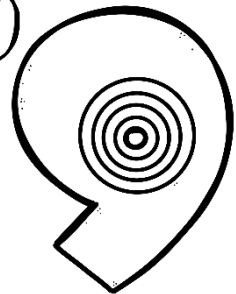
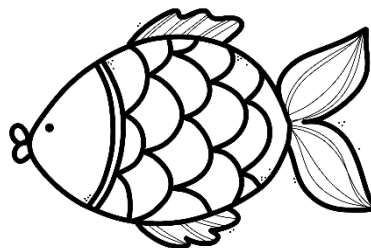
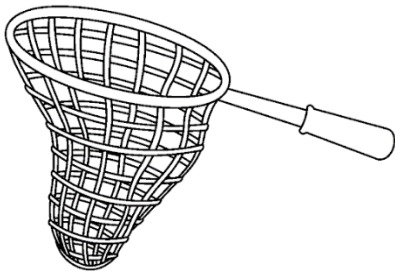
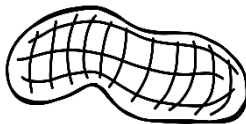
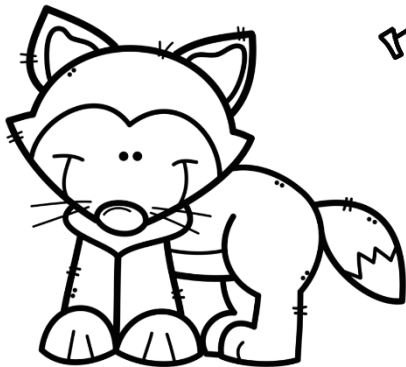
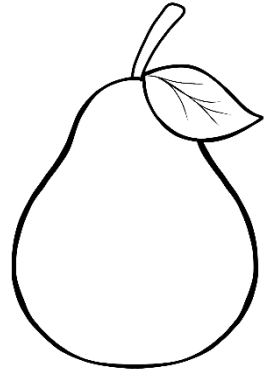
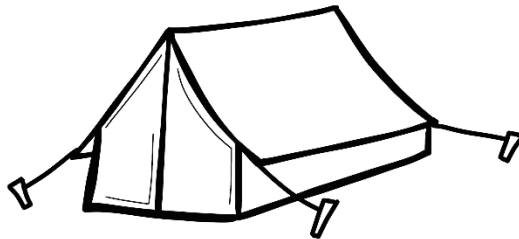
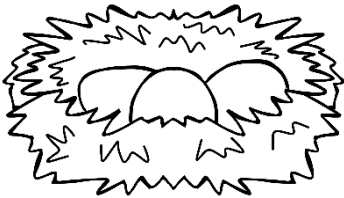
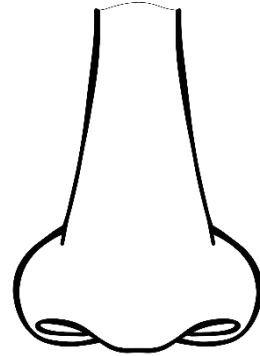
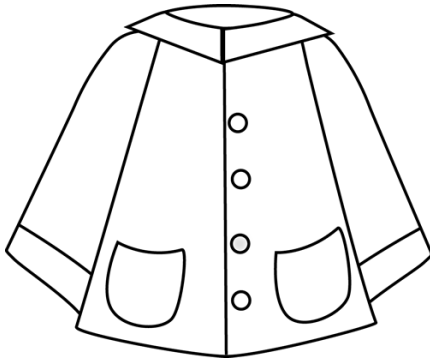
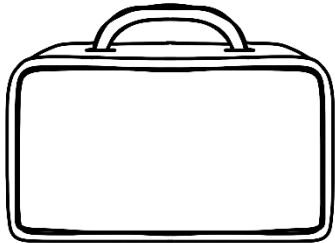

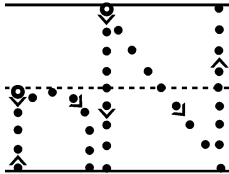
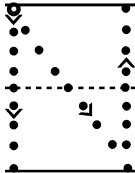
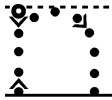
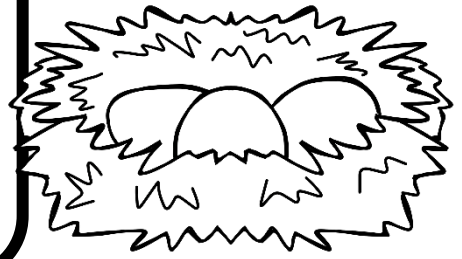
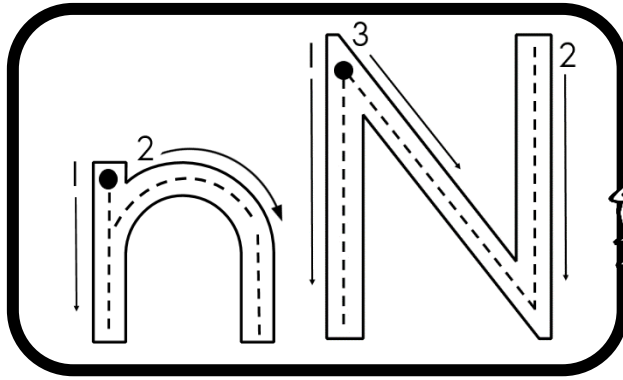

Oefen om die n-woorde te skryf.

nag	nag	
nog	nog	
nek	nek	
net	net	

nat	nat	
nes	nes	
nar	nar	
neut	neut	



Bou die volgende woorde.

ne

k	
s	
t	

na

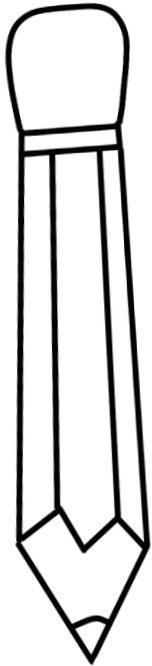
r	
t	
g	



neu

l	
s	
t	

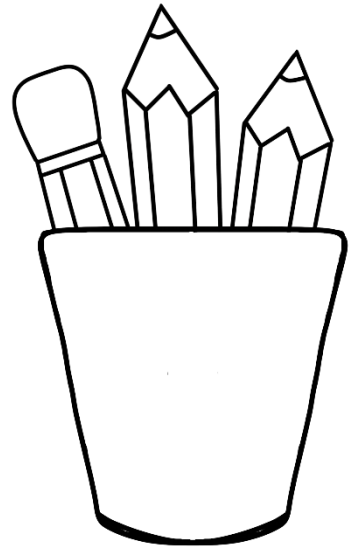

va		
pa	n	
ma		

Kleur die "x" in.

1 - blou

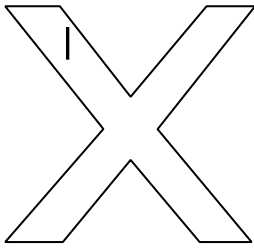

Lees die woorde.

x-straal

Xhosa

xilofoon

Xhosa-hut

Trek oor die letter.



Omkring al die x-klanke.

x	w	x
x	v	w
v	v	x

Oefen om die letter te skryf.



Vul die x-klanke op die regte plekke in.

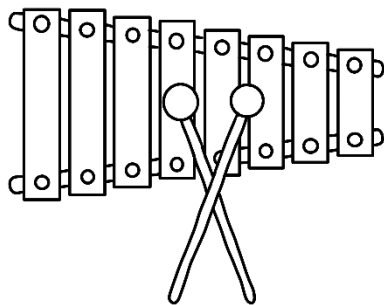
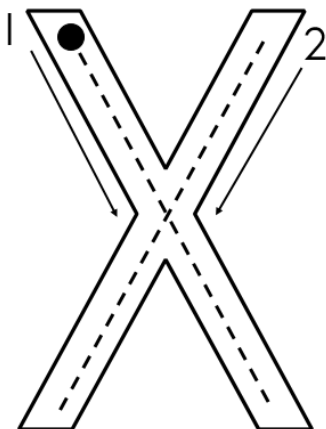

___ hosa

___ -straal

___ ilofoon

Oefen om die hoofletter te skryf.



x-klank

Kleur al die prente in wat met 'n x-klank begin.

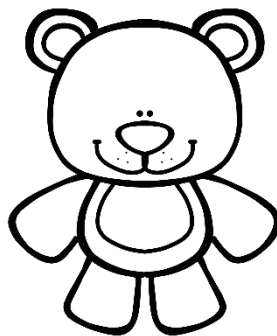
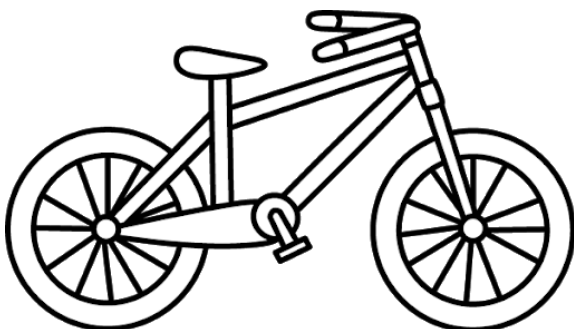
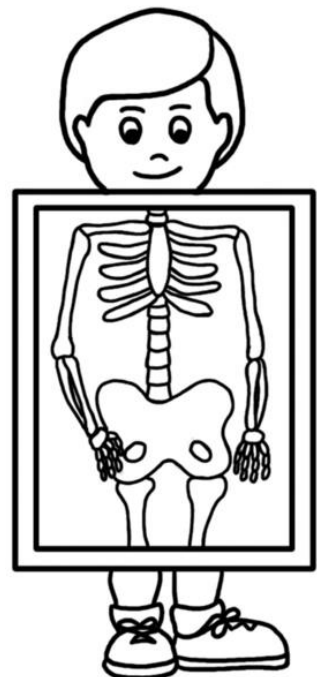
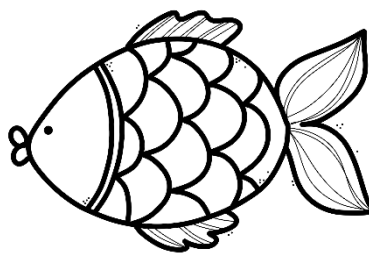
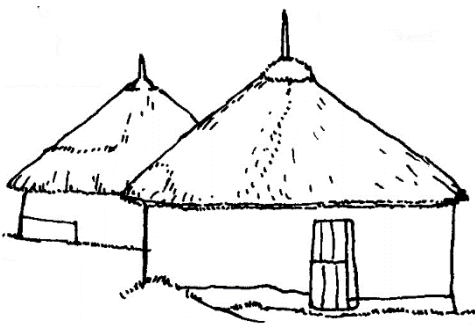
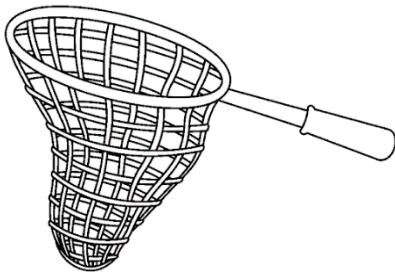
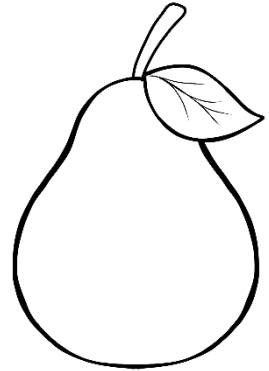
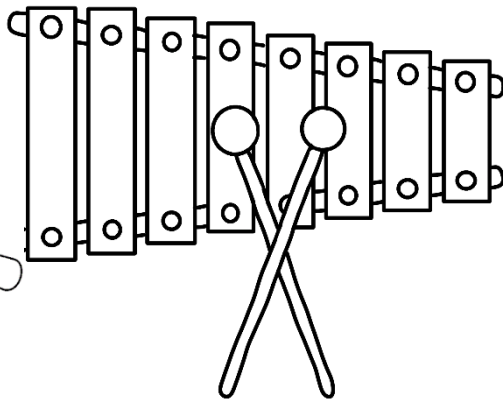
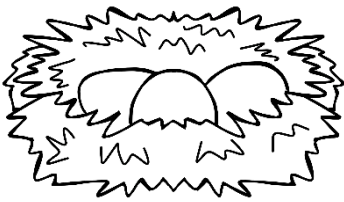
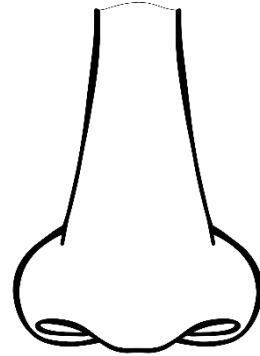
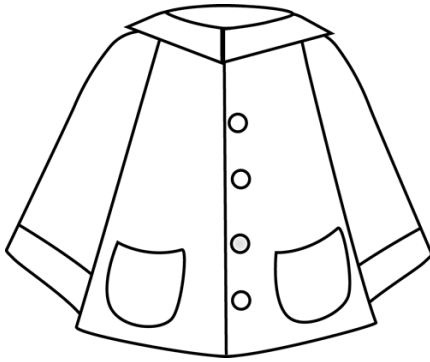
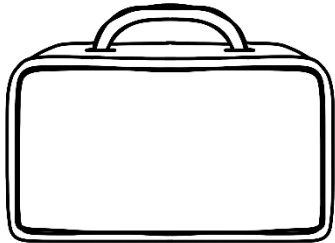

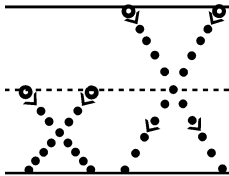
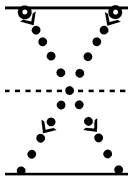
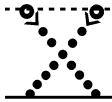
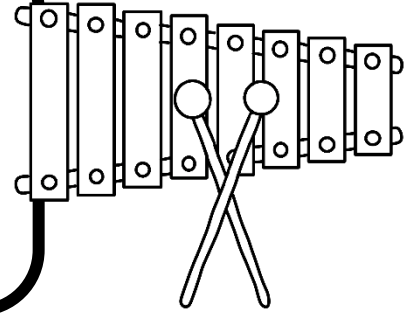
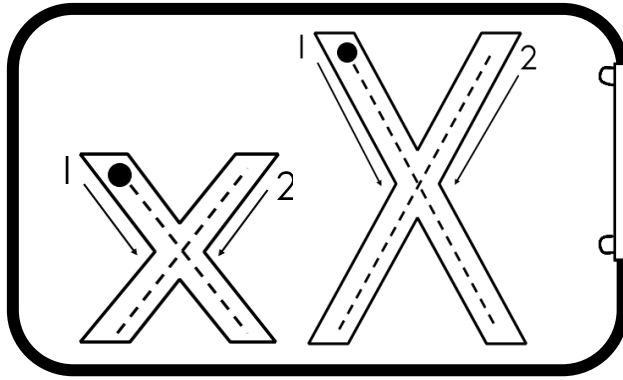

Oefen om die x-woorde te skryf.

x-straad	x-straad	
Xhosa	Xhosa	
Xhosa-hut	Xhosa-hut	
xilofoon	xilofoon	

Kleur die "rooi" in.

l - rooi

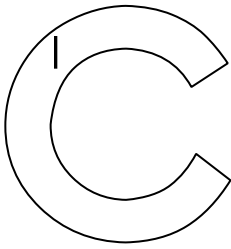

Lees die woorde.

Carla	Cornel	Coen
Corrie	Carina	Conrad
Coca-Cola		
Coen nooi vir Corrie en Cornel.		

Trek oor die letter.

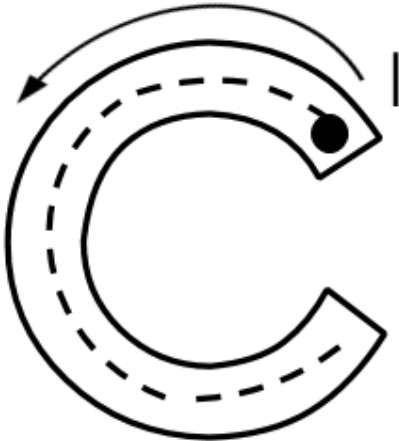

Omkring al die c-klanke.

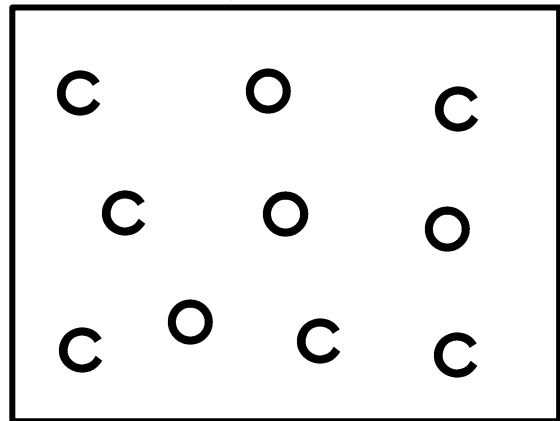

Oefen om die letter te skryf.

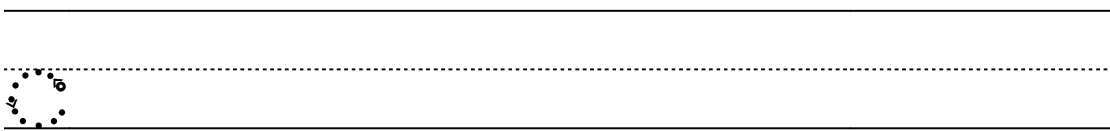

Vul die c-klanke op die regte plekke in.

__oen het vir __orrie en __ornel
na sy partytjie toe genooi.

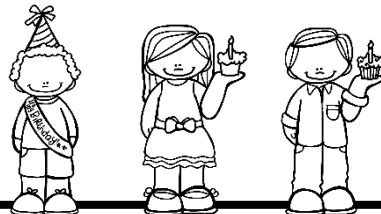
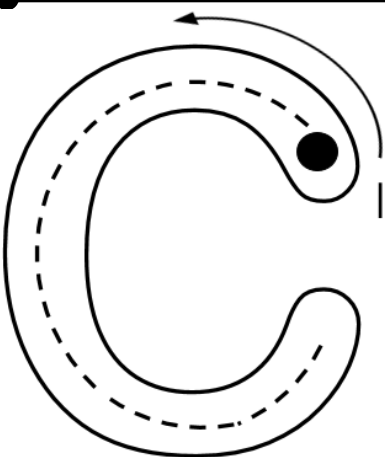

Oefen om die hoofletter te skryf.

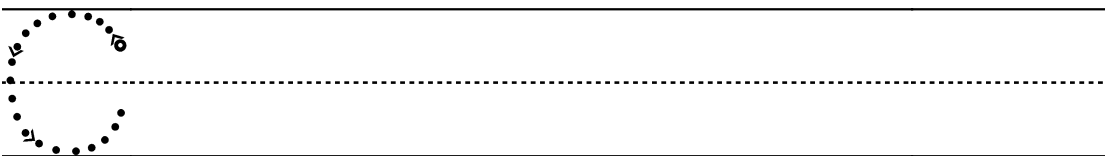

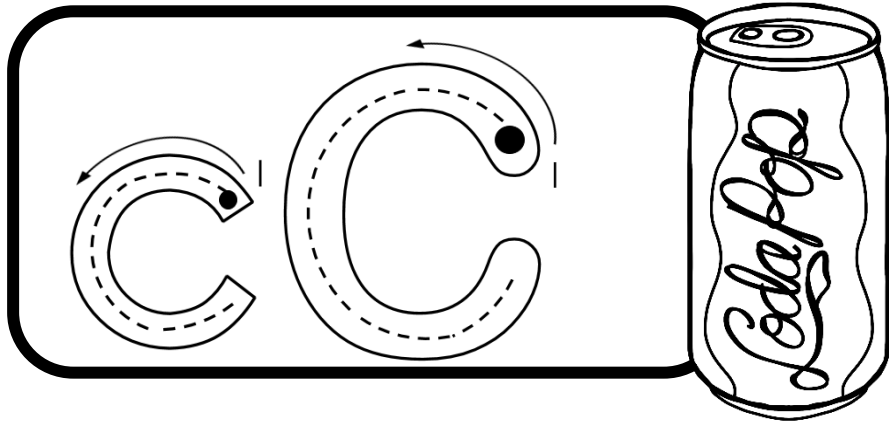

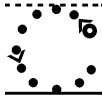

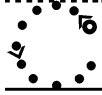

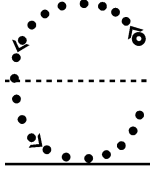

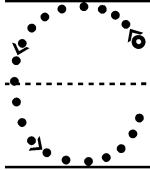

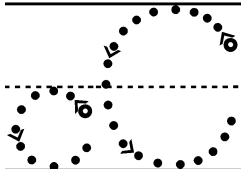

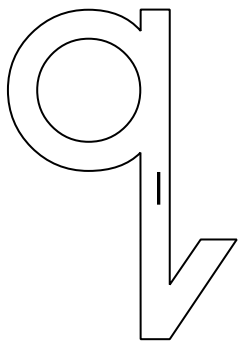

Kleur die "q" in.
I - bruin

Lees die woorde.

quiche

quiche

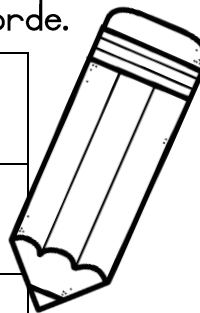

Trek oor die letter.

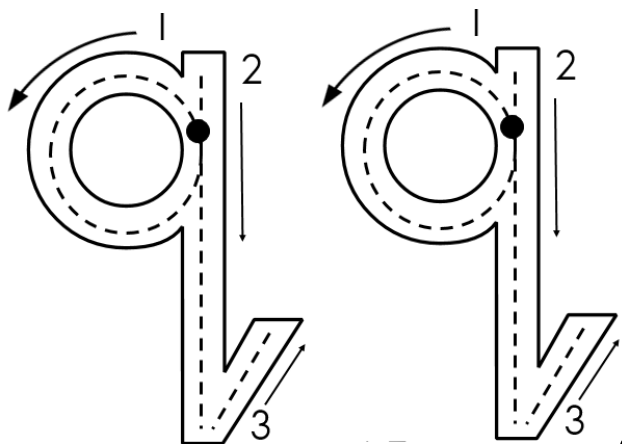

Omkring al die q-klanke.

q g p g

q q p g

Oefen om die letter te skryf.

Vul die q-klanke op die regte plekke in.

__uinton eet 'n stukkie __uiche.

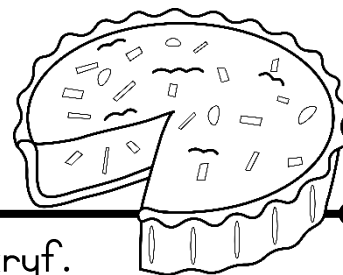
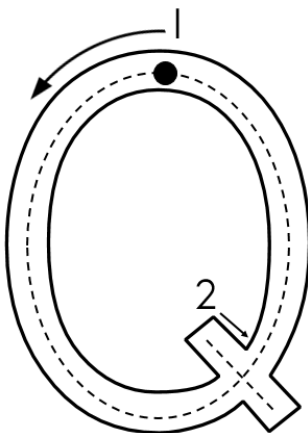

Oefen om die hoofletter te skryf.

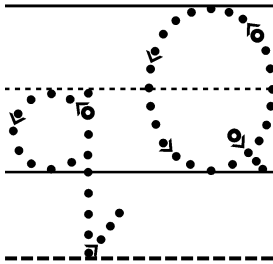
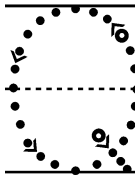
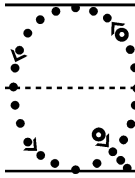
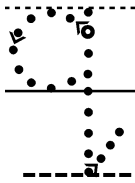
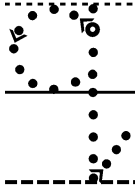
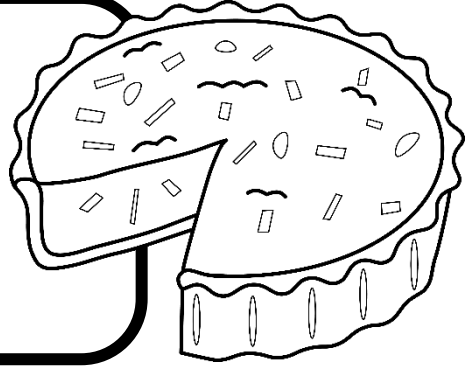
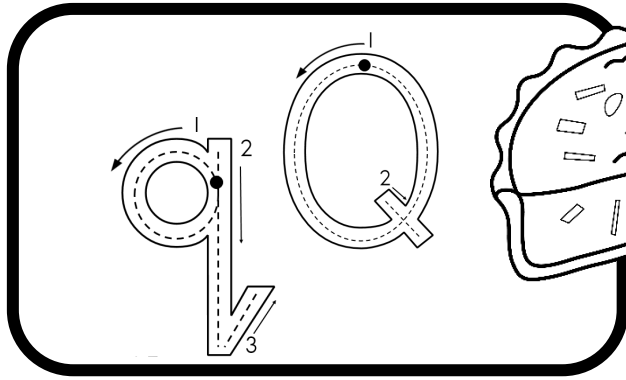

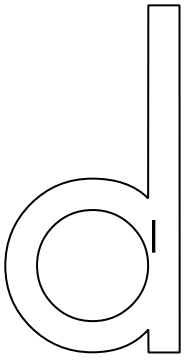

Kleur die "d" in.

l - pers

Lees die woorde.

das	donkie	dier	duif
dag	dokter	drie	dalk
die	diamant	deur	duik

Trek oor die letter.

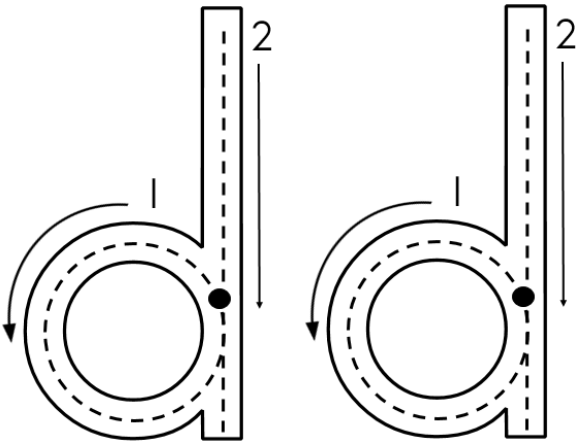

Omkring al die d-klanke.

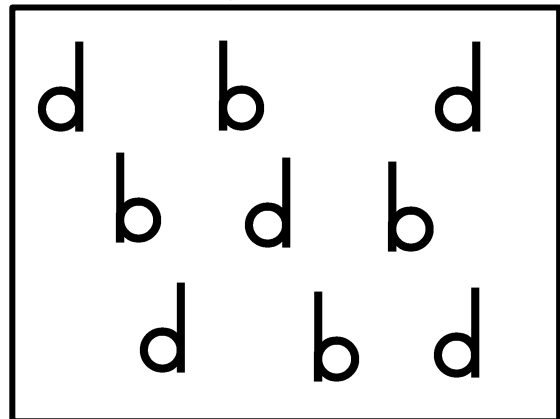

Oefen om die letter te skryf.

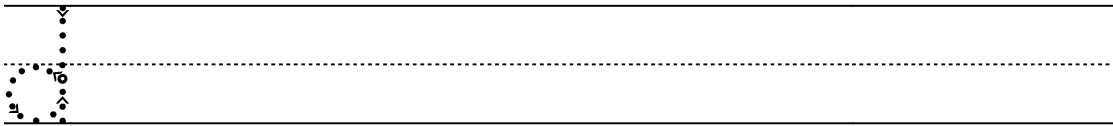

Vul die d-klanke op die regte plekke in.

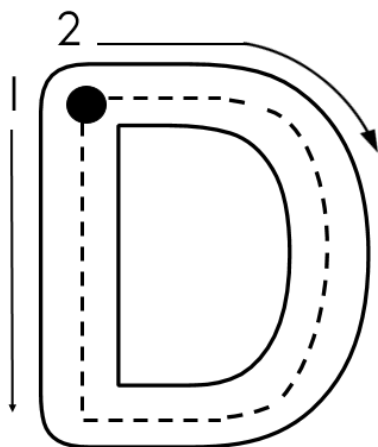

__as	! __eur	! __ier
__ag	! __alk	! __onkie
__ie	! __duik	! __okter
__rie	! __uif	! __iamant

Oefen om die hoofletter te skryf.

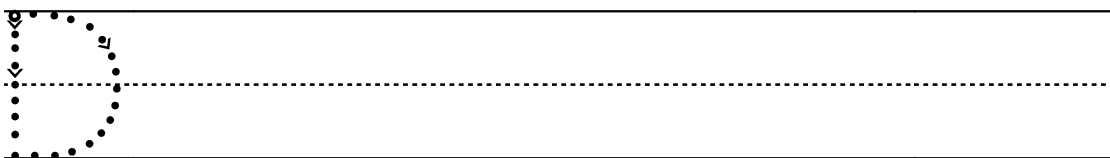

d-klank

Kleur al die prente in wat met 'n d-klank begin.

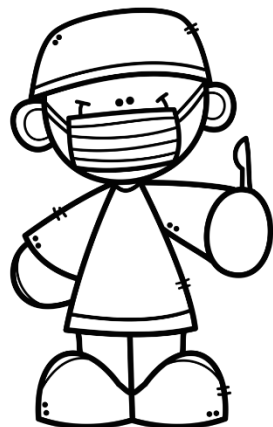
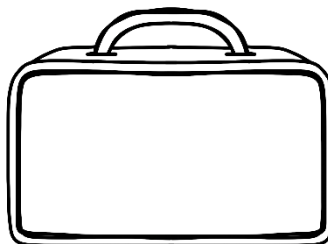
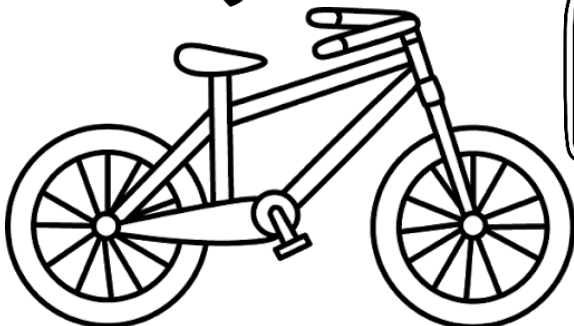
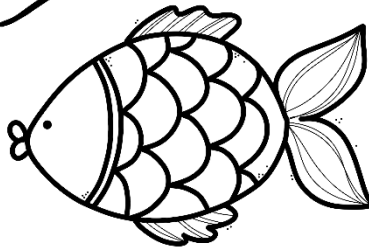
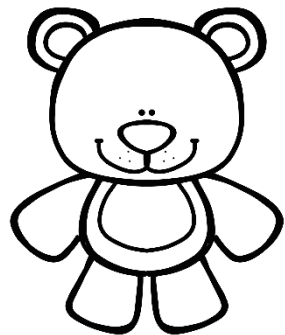
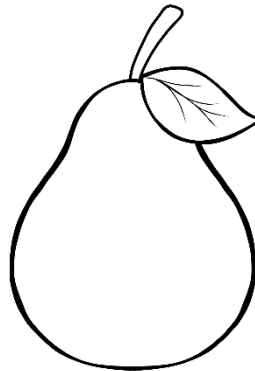
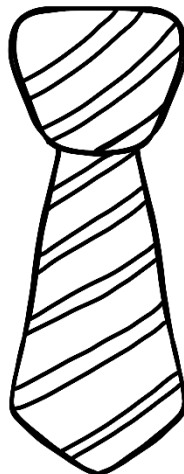
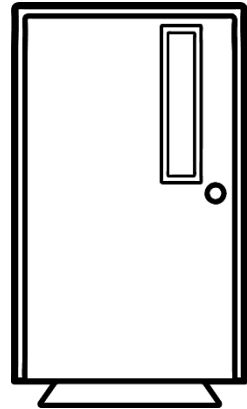
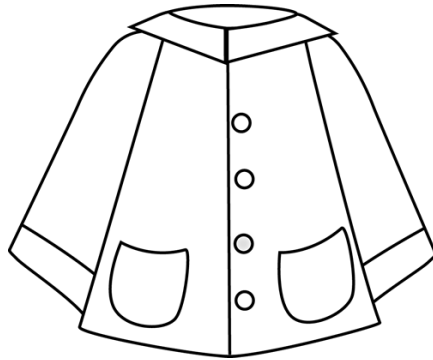
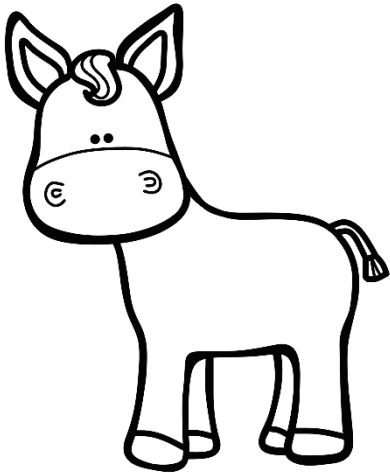

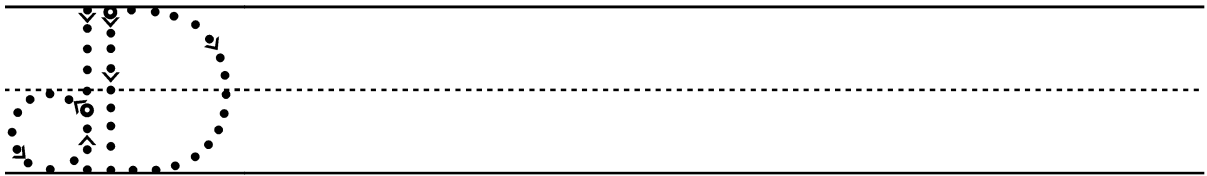
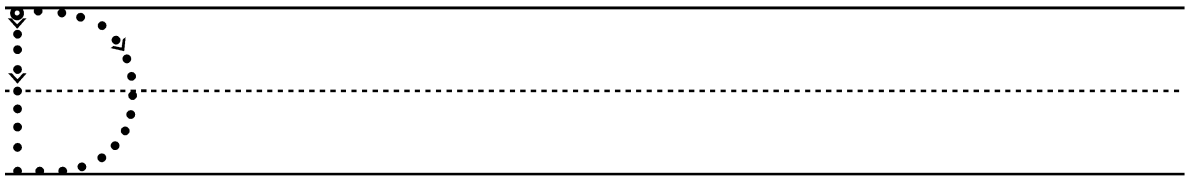
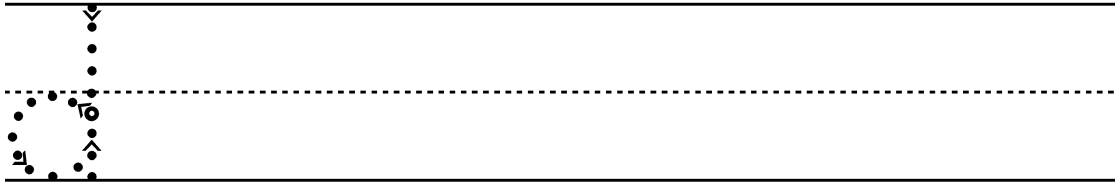
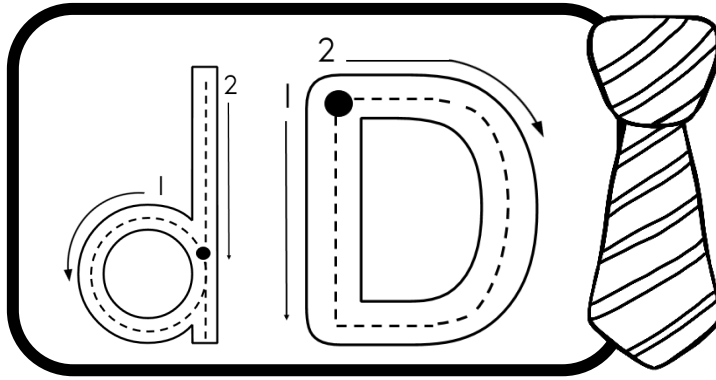

Oefen om die d-woorde te skryf.

dag	dag	
das	das	
die	die	
deur	deur	

drie	drie	
dier	dier	
duif	duif	
duik	duik	

b en d

Vul die b- en d-klank in om die woorde te voltooi.



straa__

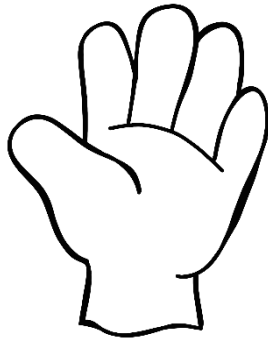

han__

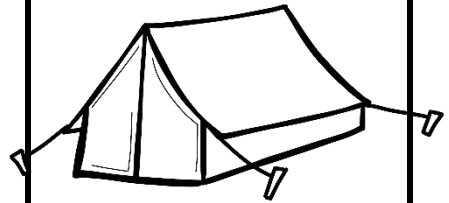

ten__

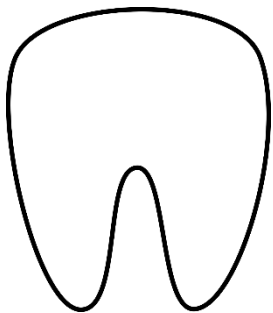

tan__

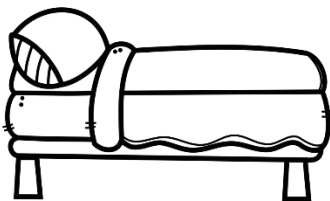

be__

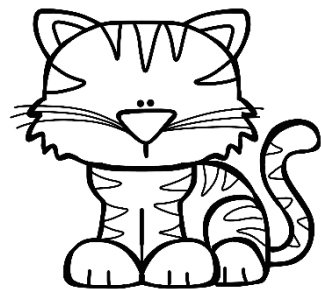

ka__

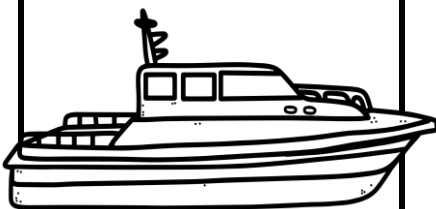

boo__



naal__



hu__

Kleur die "z" in.

1 - oranje

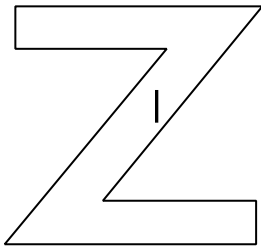

Lees die woorde.

zoem

Zoeloe

zero

Trek oor die letter.

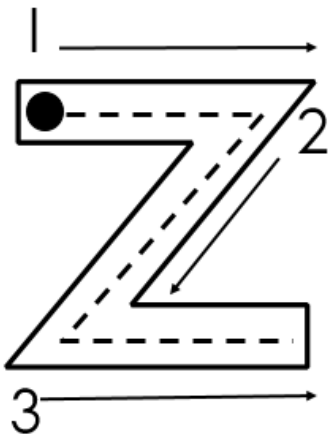

Omkring al die z-klanke.

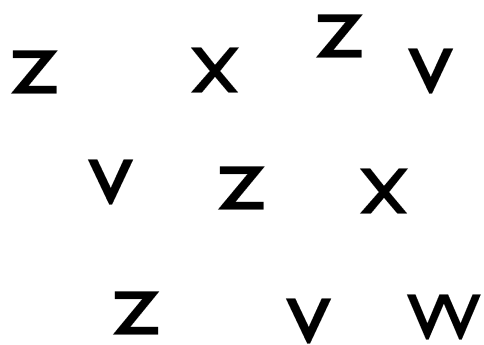

Oefen om die letter te skryf.

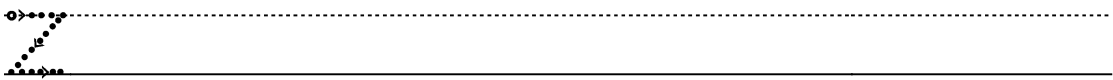

Vul die z-klanke op die regte plekke in.

Die bye __oem om die sebra.

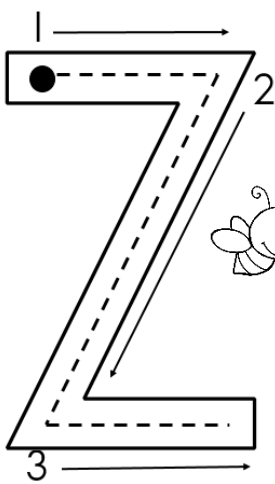

Oefen om die hoofletter te skryf.

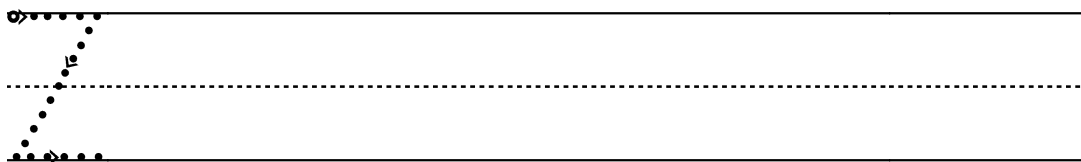

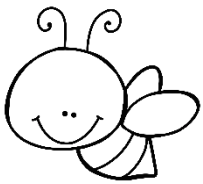
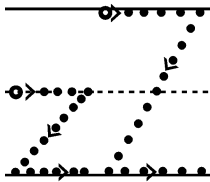
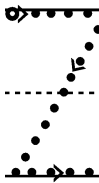
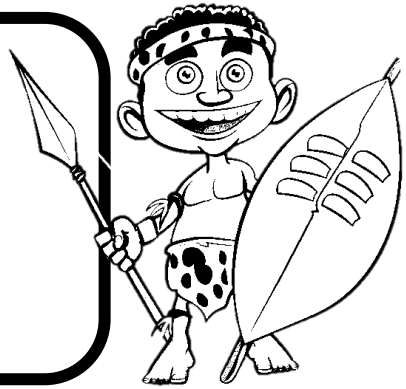
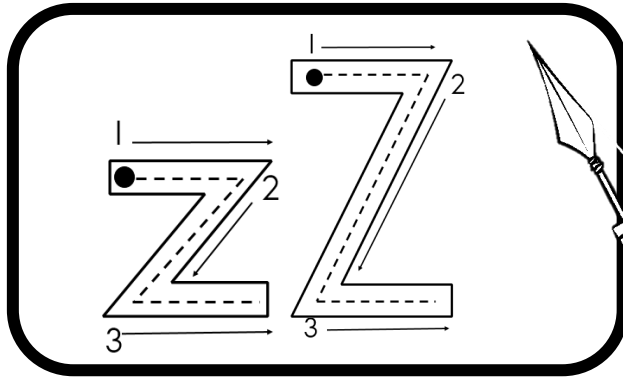

zoem

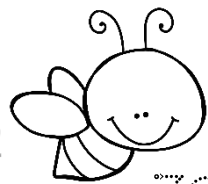
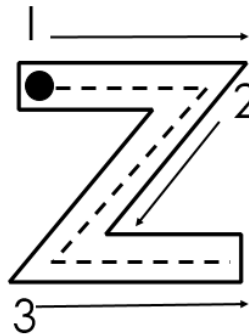
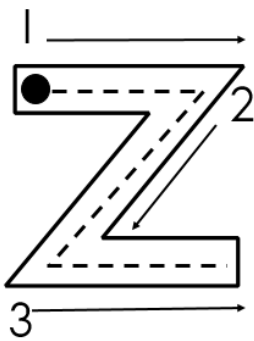

zoem

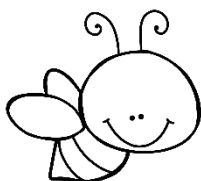

zoem

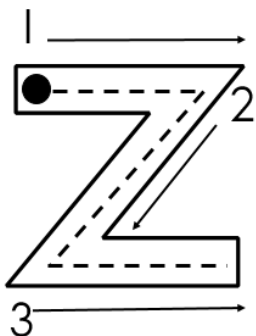

zoem

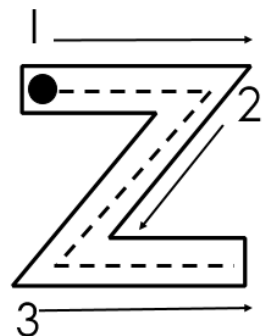

Teenoorgesteldes



oud

oud

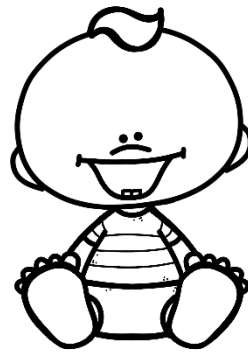

jonk

jonk

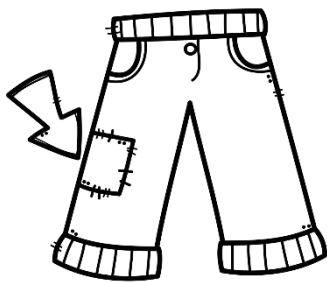

oud

oud

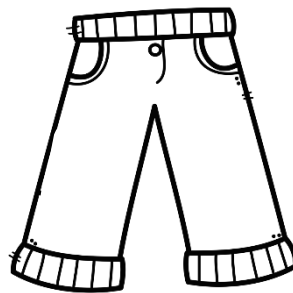

nuut

nuut

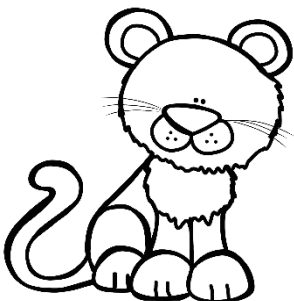

vinnig

vinnig

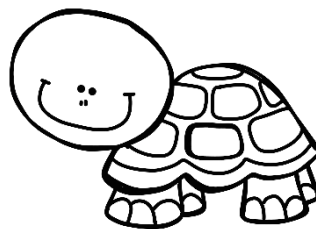

stadig

stadig