

GRADE 3
LIFE SKILLS

Term 3



Name:

Dangerous places to play

You feel welcome in safe places. These are places you will always feel you can go back to. Nobody will hurt or harm you there.

A place that is safe for the public is a place where everyone feels welcome. Nobody will be hurt or harmed there.

"Public safety" means that everyone has the right to be safe in places that are open to the public, like trains, taxis and beaches.



1. Why is it dangerous to play on a dumping site?

2. What dangerous objects will you find at a dumping site?

3. What other places are dangerous to play at?

Dangerous places to play

Read each sentence. Colour in the correct mark if you agree with the sentence or colour in the incorrect mark if you do not agree.



1. You feel welcome in safe places.	<input type="checkbox"/>	<input type="checkbox"/>
2. It is dangerous to play near a railway of a train.	<input type="checkbox"/>	<input type="checkbox"/>
3. It is dangerous to play in the street where cars are driving.	<input type="checkbox"/>	<input type="checkbox"/>
4. It is safe to take a sip of cleaning products.	<input type="checkbox"/>	<input type="checkbox"/>
5. It is safe to play at a power station.	<input type="checkbox"/>	<input type="checkbox"/>
6. A place that is safe for the public is a place where everyone feels welcome. Nobody will be hurt or harmed there.	<input type="checkbox"/>	<input type="checkbox"/>

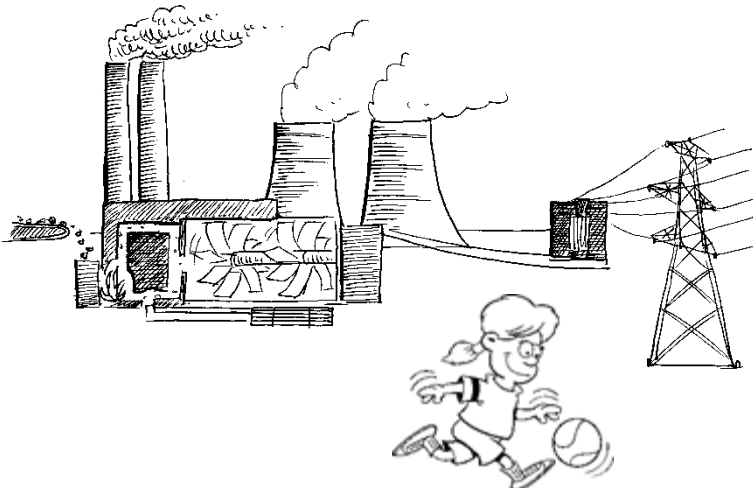

Dangers

Look at the pictures. Then choose one of these captions to write under each picture.

- The boy will burn his hand if he touches the hot stove.
- The boy will die if he drinks the poison.
- The boy and girl will set the carpet on fire if they play with the matches.
- The baby will shock when he sticks his finger in the socket.

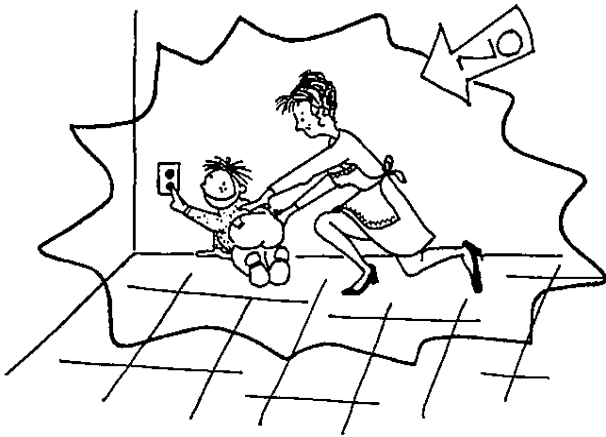

Danger! Danger! Danger!

There are a few dangerous things that can hurt the boy in the picture. Find them and colour them in.

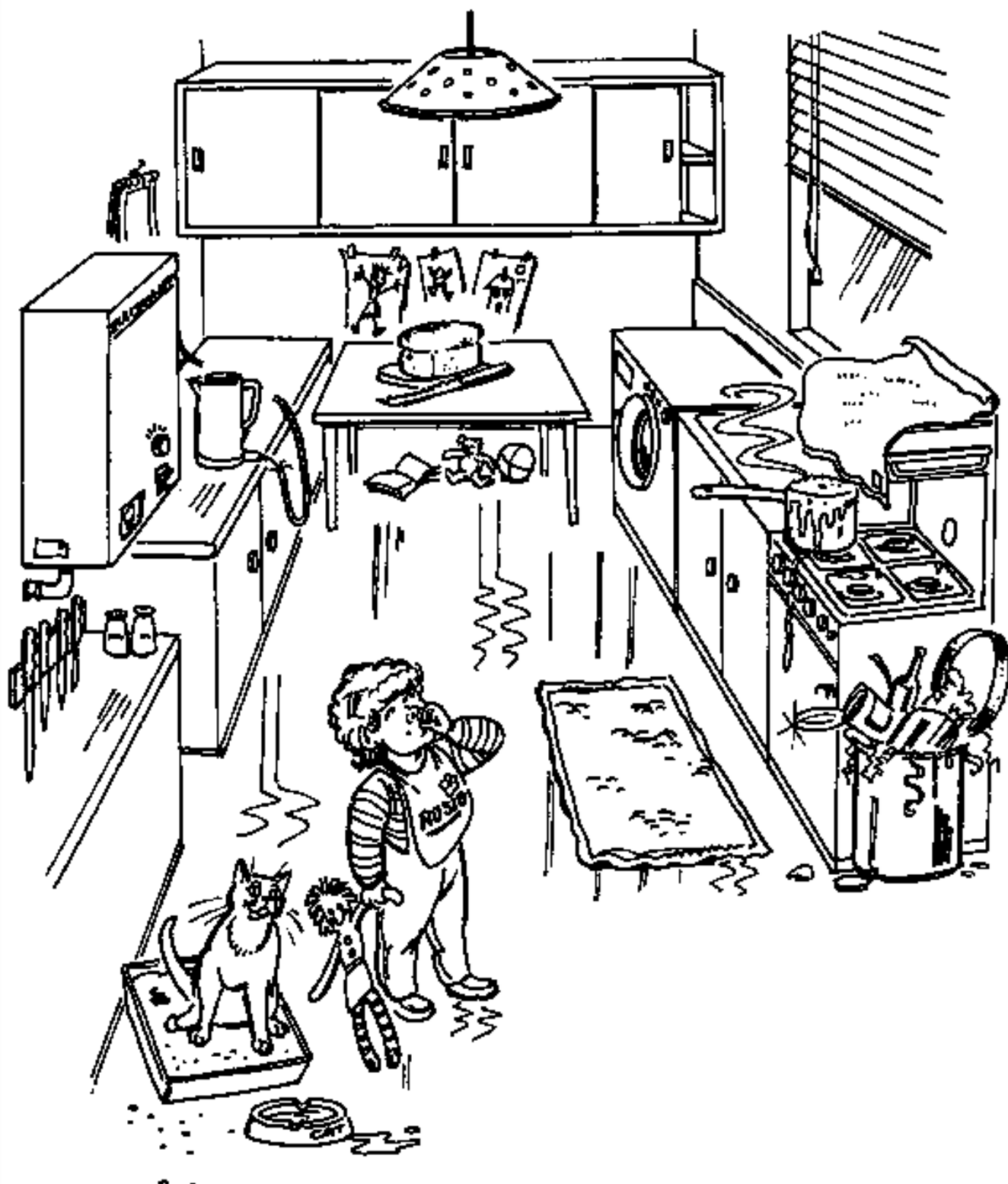

Signs that warn us of danger



Road and railway signs are there for our safety. Some of the signs help to protect us. They warn us of danger. Other signs tell us how we should behave in traffic. Warning signs on the road always have a red line around them.

Here are a few signs.



roadworks



pedestrian



railway crossing



general warning



pedestrian crossing



stop



pedestrian prohibited

Signs that warn us of danger

Match the words with the correct signs by drawing a line with a ruler.

pedestrian crossing

pedestrian

general warning

roadworks

railway crossing



Pollution

What is pollution?

Pollution means the contamination of air, soil, water and the environment. Loud noises and sounds are also a type of pollution

Air pollution

Air is polluted when harmful gasses are released into the air. Smoke which is released from burning coal, fuel, gasses and wood pollute the air.



Water pollution

Water pollution is when underground water is polluted, as well as the water of dams and rivers. This happens when factories pump dirty water into rivers and when sewage from our toilets leak into the water.



Noise pollution

Noise pollution is caused by trucks, the hooting of taxi's, factory machinery, loud music and equipment which is used at building sites. Too much noise can make you deaf.



Land pollution

Harmful chemicals can pollute the land. Land pollution is caused by the waste of factories and mines. The plastic and dirt which we throw on the ground is also pollution



Pollution

Look at each picture and write down what type of pollution it is.

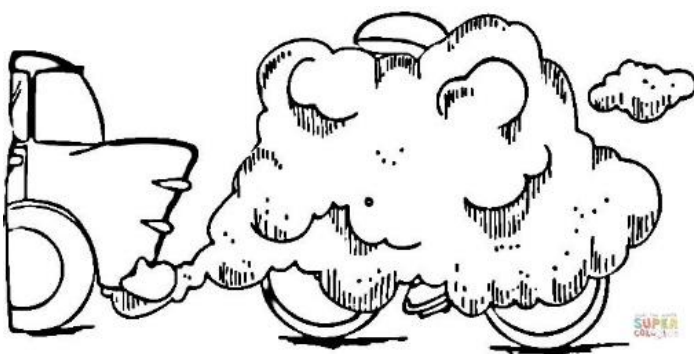
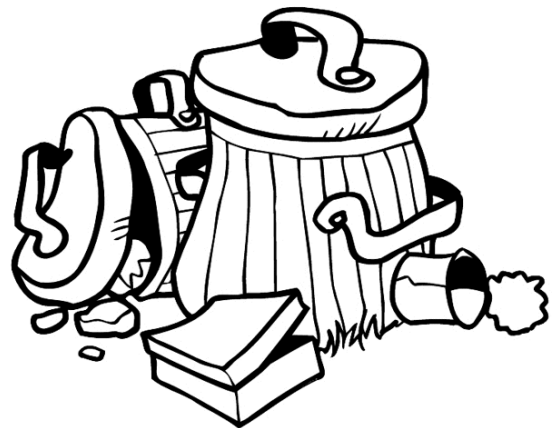
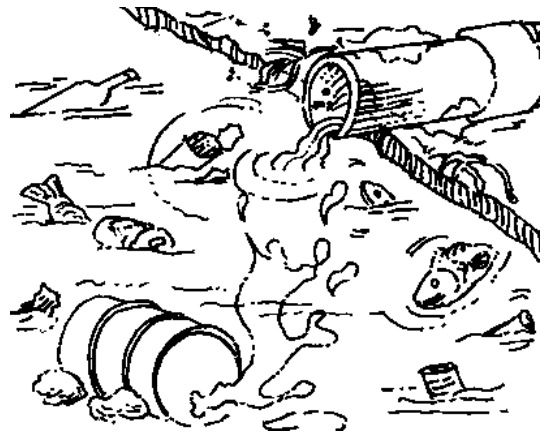
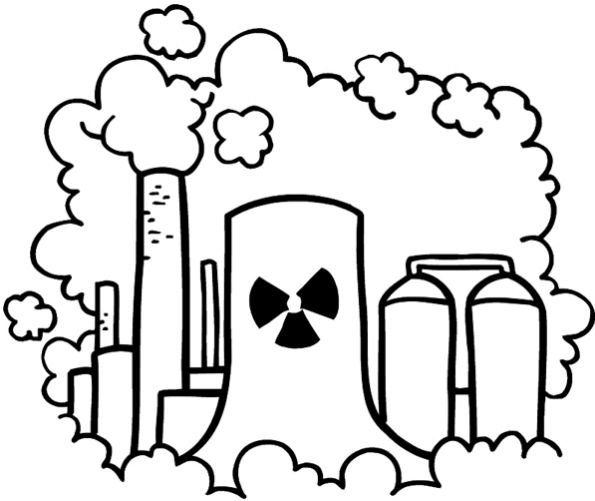

Pollution

Write down 5 examples of pollution in the picture.



How people lived long ago

The things that we do and how we do them change over time. Long ago people lived close to the things they needed, for example food and water. Today we need the same things, but technology brings food, water and electricity to us where we need them.

Look at the pictures and make a list of things that we do differently today than long ago.

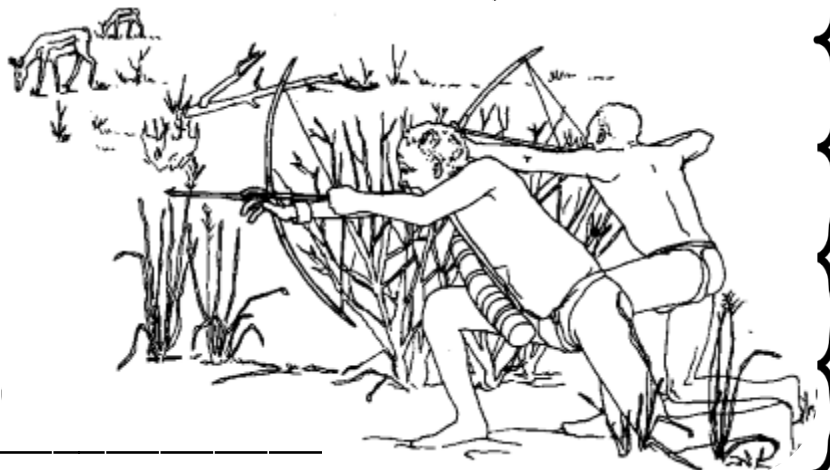
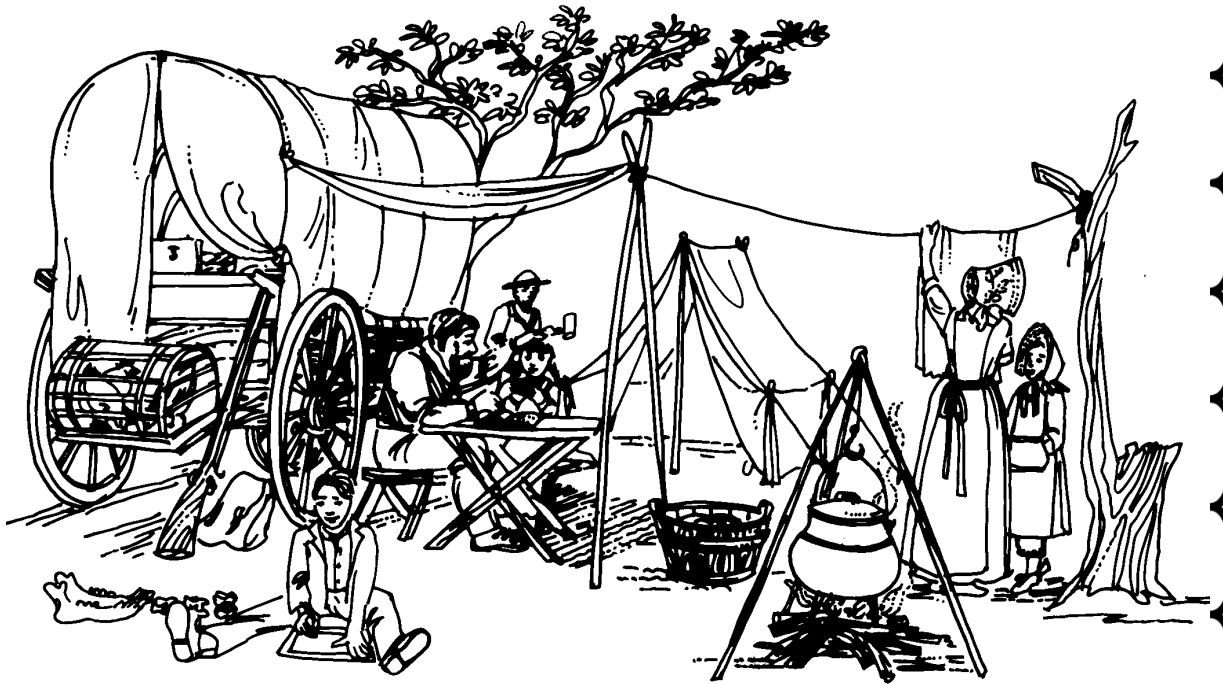

Present or past

Look at each thing in the pictures and say whether it belongs in the present or in the past. Write "Present" (for now) or "Past" (for long ago) below each picture.

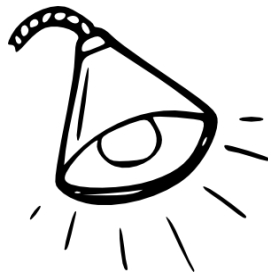

Paying for things

Use the words in the circles to complete the sentences.

1. Long, long ago, people did not use _____ and notes to _____ for things. In those days, they used _____ as a way of exchanging goods.
2. If someone had a lot of _____, but not enough food to _____, she or he needed to find someone who would exchange some food for tobacco.
3. Things such as _____, salt, _____, cattle and tobacco were exchanged.
4. Later people began using pieces of _____ and _____ to pay for goods. Later, the pieces of metal were used to make _____.
5. Today, we use _____ and _____ or credit cards to pay for goods.

tobacco

gold

bartering

eat

food

silver

notes

coins

animal skins

beads

pay

Light

Write the words in the block at the correct picture.

candle

torch

lantern

globe

headlamp

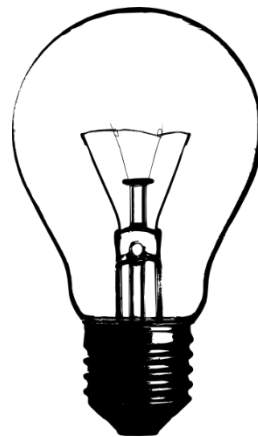
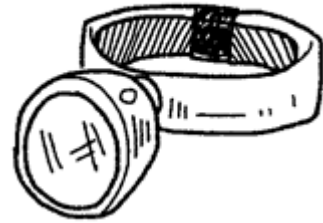
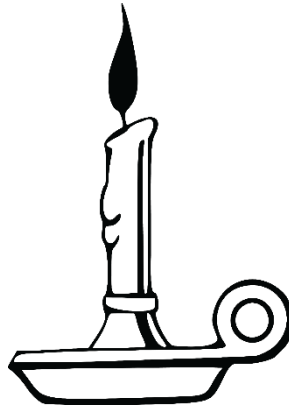

Space

- **The sun:** A very, very hot ball of gas. Deep inside the sun it is so intensely hot that gases "melt" together. This "melting" process gives us light, heat and energy on earth. The sun is a star.

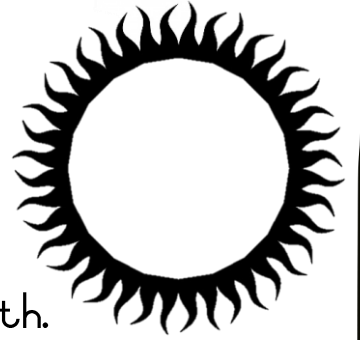

Planets: There are eight planets, including the earth.

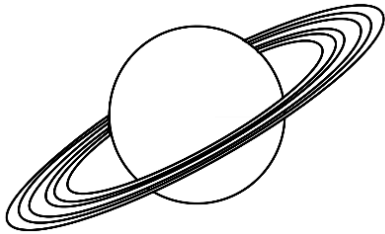

Meteors: These are large chunks of rock that move through space until they hit our atmosphere. They then become extremely hot, begin to melt and burn out. This forms a glowing stripe in the night sky. We call them "shooting stars". If they hit the surface of the earth before they are fully burnt out, we call them "meteorites".



- **The moon:** The moon is a cold, dead ball of rock and dust that revolves around the earth. It is 4 times smaller than the earth

stars

- **Stars:** The stars are intensely hot balls of gas, like the sun, but very, very far from us. There are billions upon billions of stars $\frac{5}{5}$ we could never count them all. Stars come in many different sizes $\frac{5}{5}$ our sun is a medium-sized star.

Universe: We call our solar system and outer space the universe. The universe is everything that exists, and we know very little about it.

Telescope: Today we have telescopes far in space that can send us pictures of very distant parts of the universe that we cannot see from earth. An example is the Hubble telescope, which sends us beautiful images from space. South Africa built its own large telescope near Sutherland in the Northern Cape.



- **Satellite:** An object that goes around something else is called a satellite, so the moon is a satellite of the earth. The path of a satellite is called its orbit.

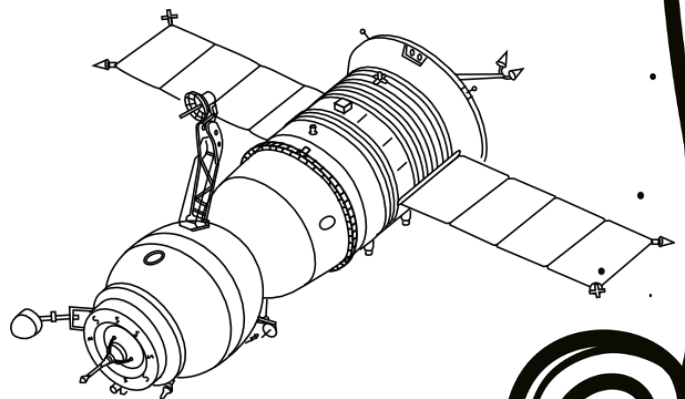

SPACE

Complete the crossword puzzle by using the hints below.

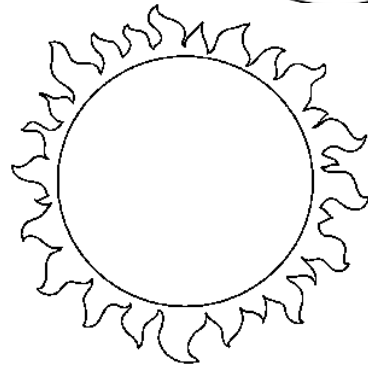
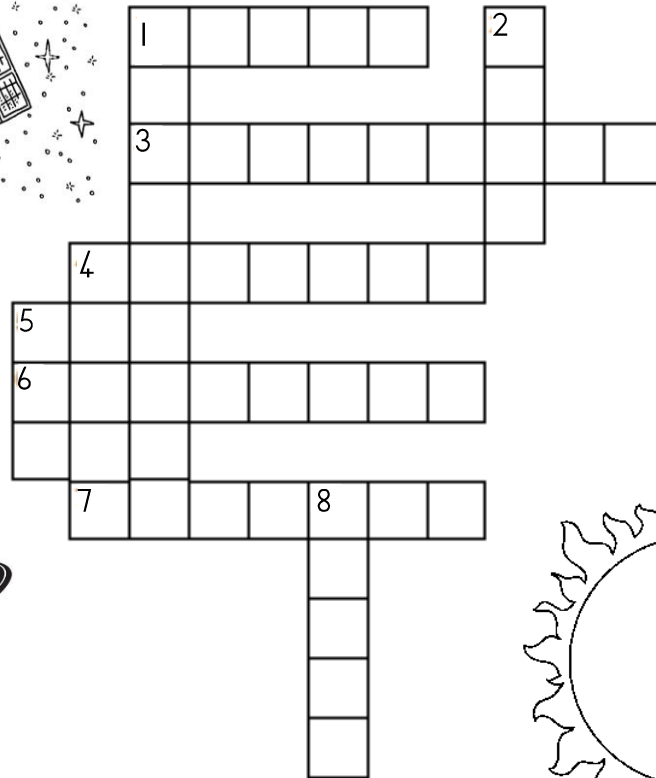
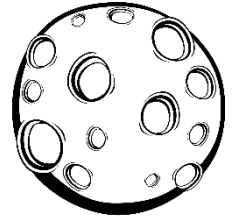
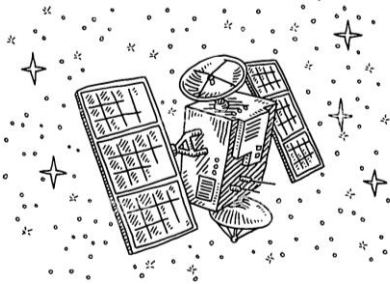

DOWN

- 1 An object that goes around something else.
- 2 A cold, dead ball of rock and dust that revolves around the earth.
- 5 A very, very hot ball of gas.
- 8 The path of a satellite is called its _____.

ACROSS

- 1 Intensely hot balls of gas, like the sun, but very, very far from us.
- 3 Today we have _____ far in space that can send us pictures of very distant parts of the universe that we cannot see from earth.
- 4 There are eight planets, including the earth.
- 6 We call our solar system and outer space the _____.
- 7 These are large chunks of rock that move through space until they hit our atmosphere. They then become extremely hot, begin to melt and burn out.