

Ek leer hoe om

my naam te

SKRYF



Nathan

My naam is:

Nelson

Die eerste letter van my naam is:

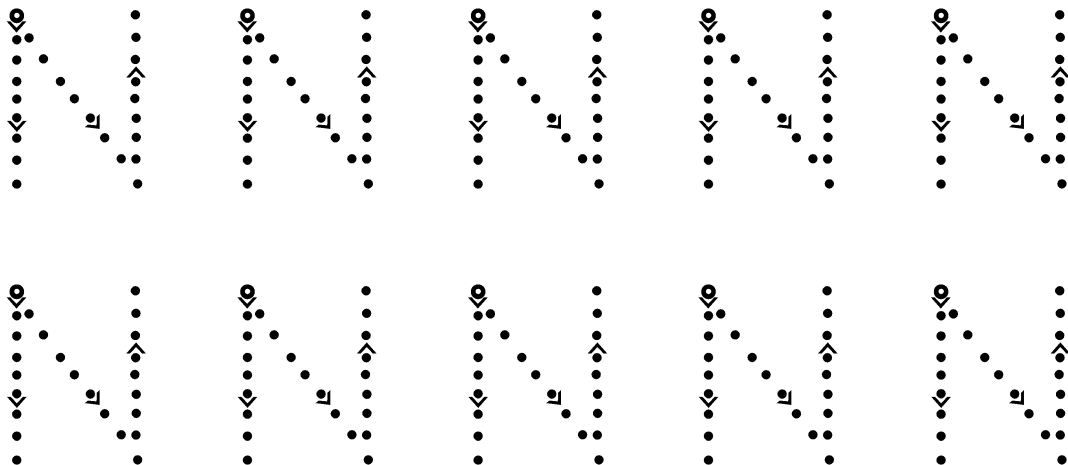
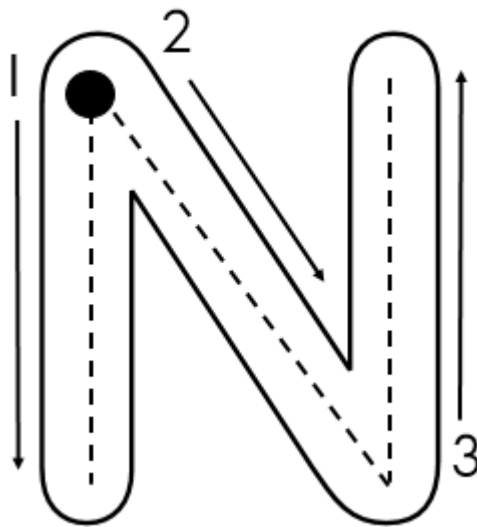

My naam is:

Walter

Walter

Walter

Walter

Walter

My naam is:

John

John

John

John

John

My naam is:

Nathan

Nathan

Nathan

Nathan

Nathan

Die letters in my naam is:

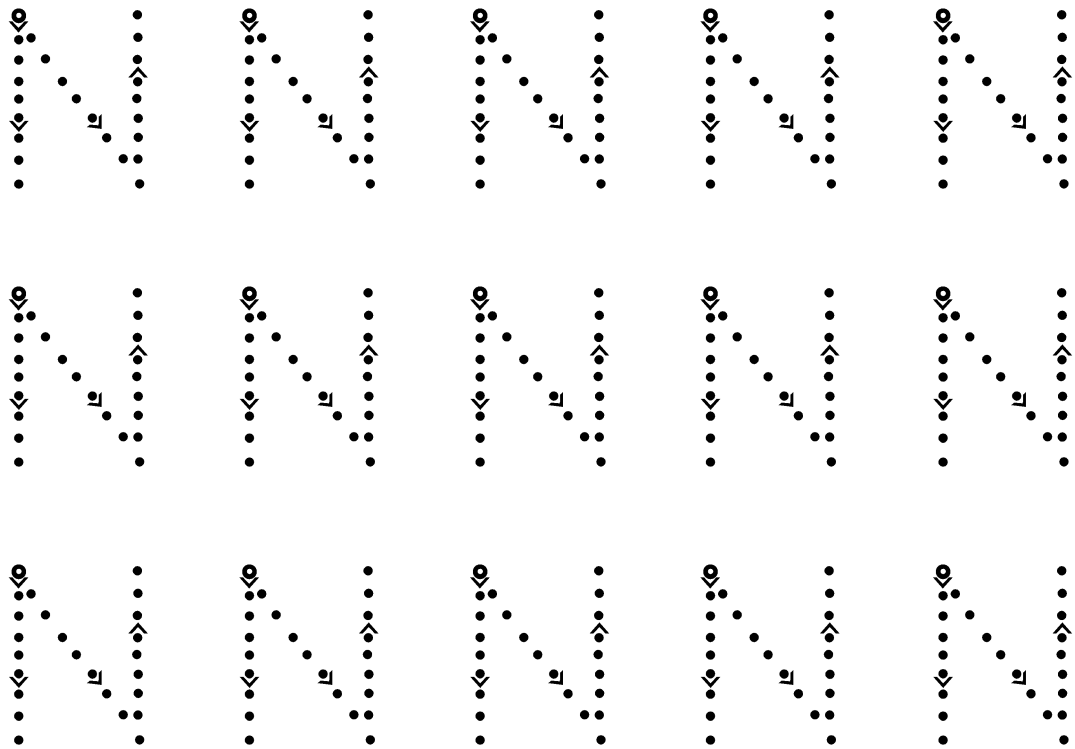
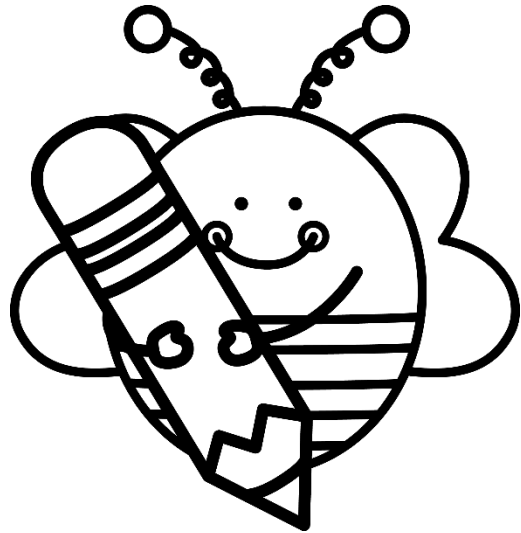
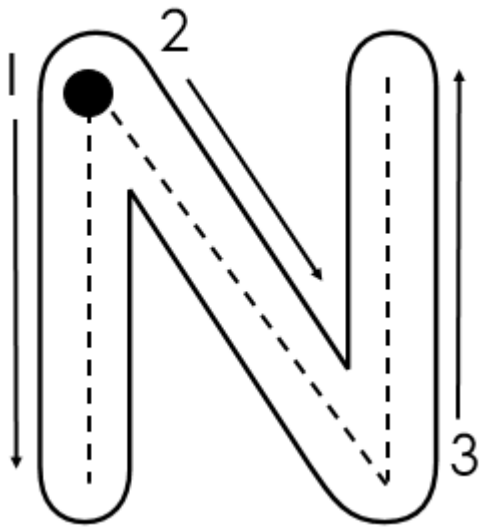

Die letters in my naam is:

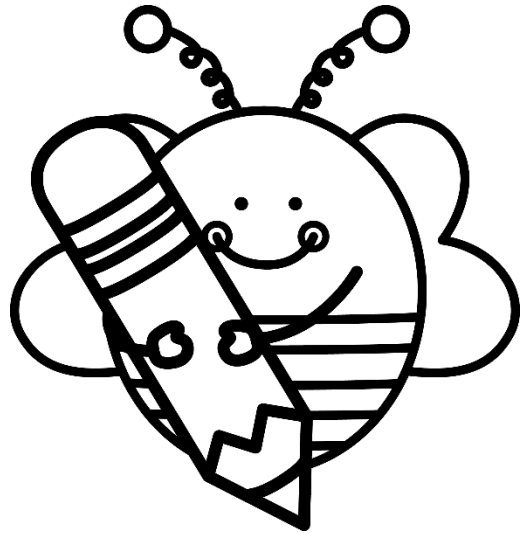
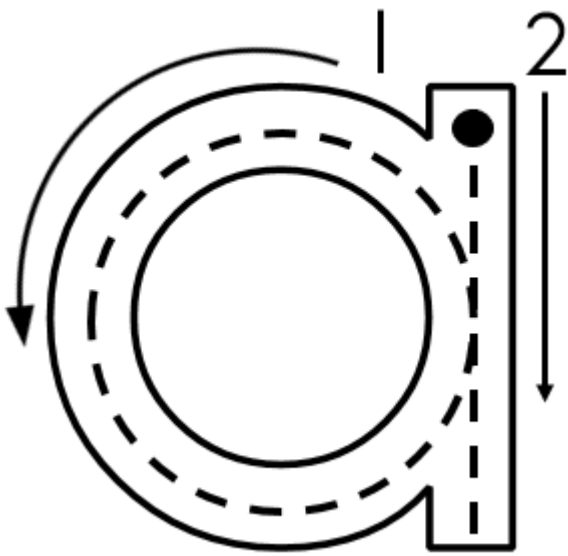

Die letters in my naam is:

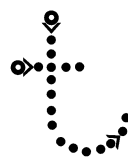
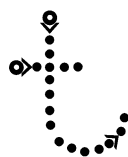
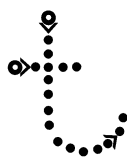
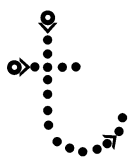
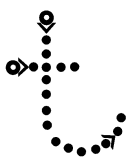
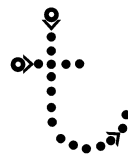
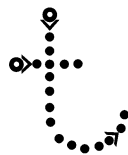
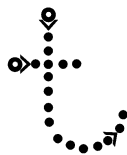
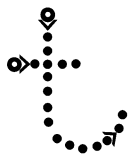
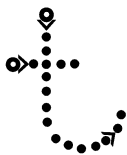
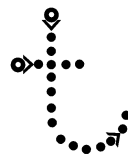
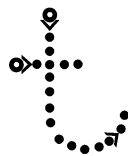
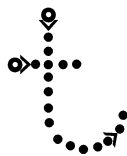
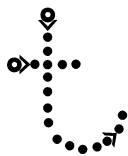
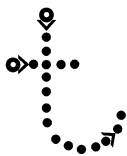
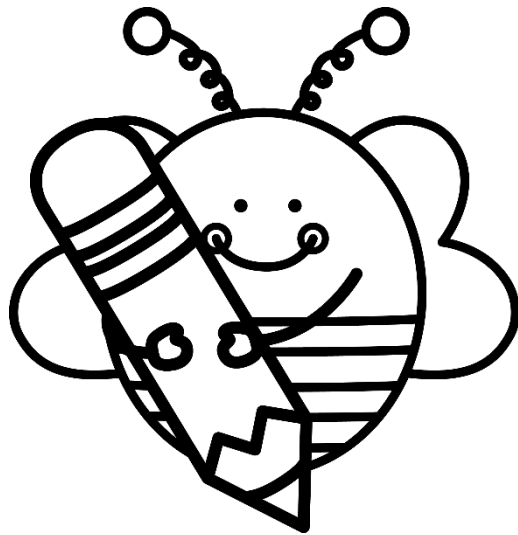
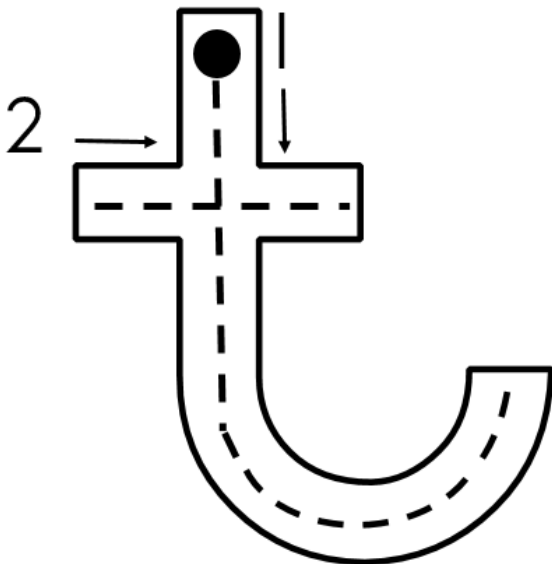



Die letters in my naam is:

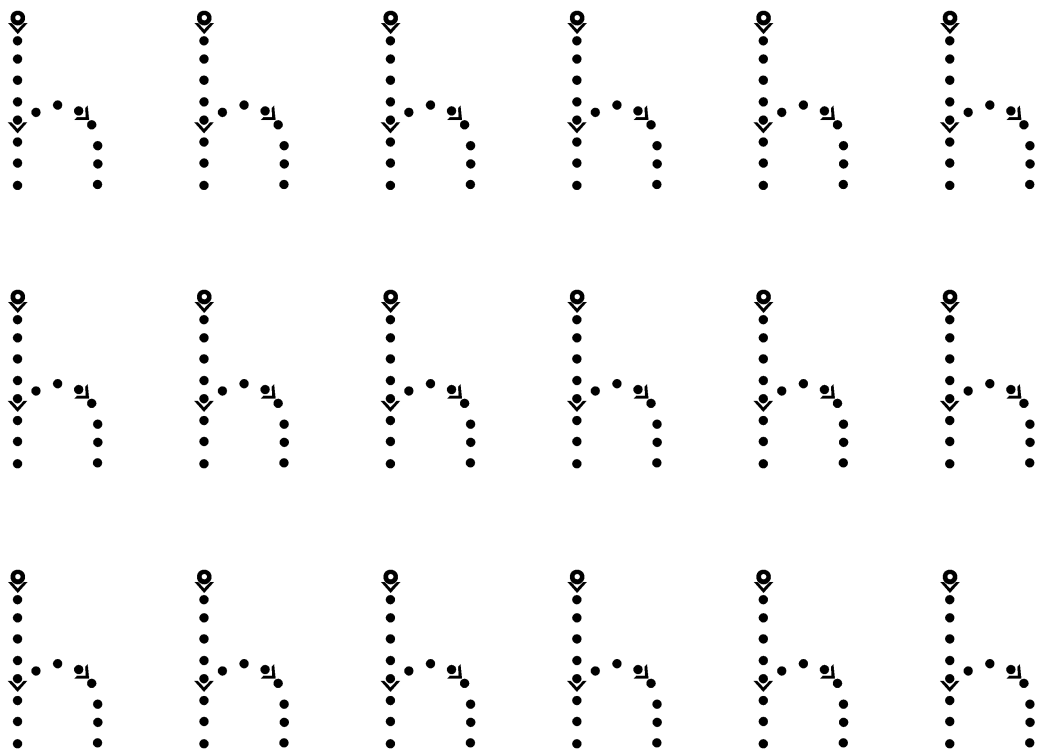
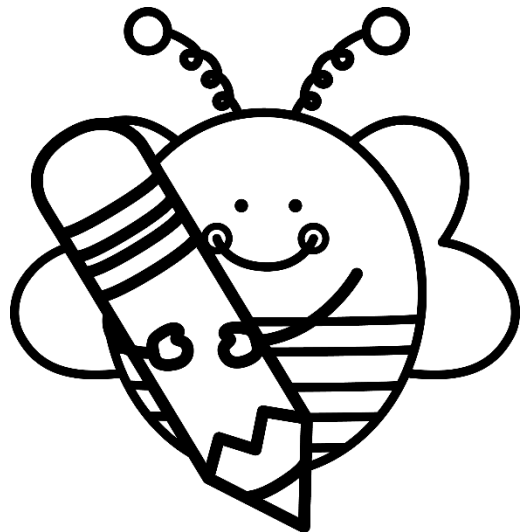
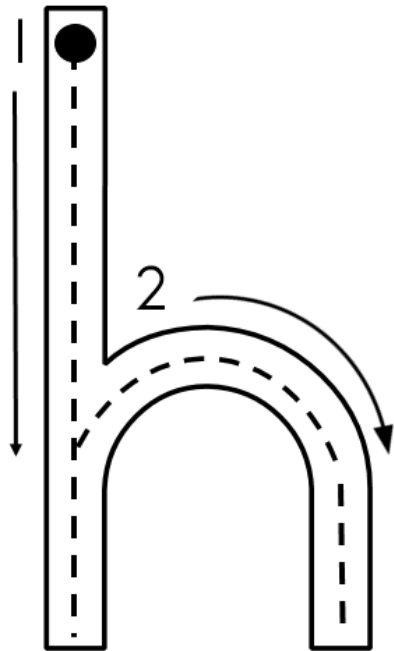

Die letters in my naam is:

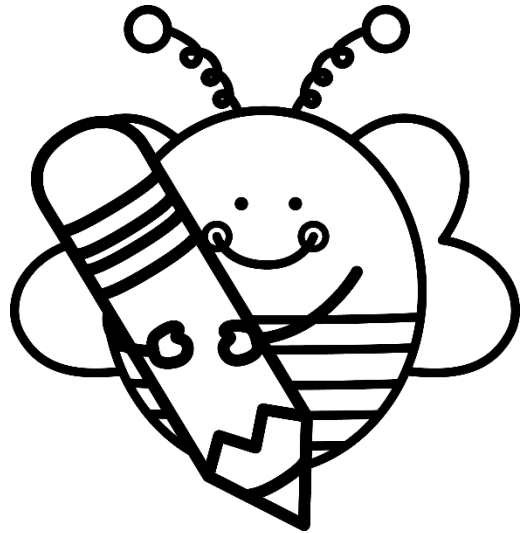
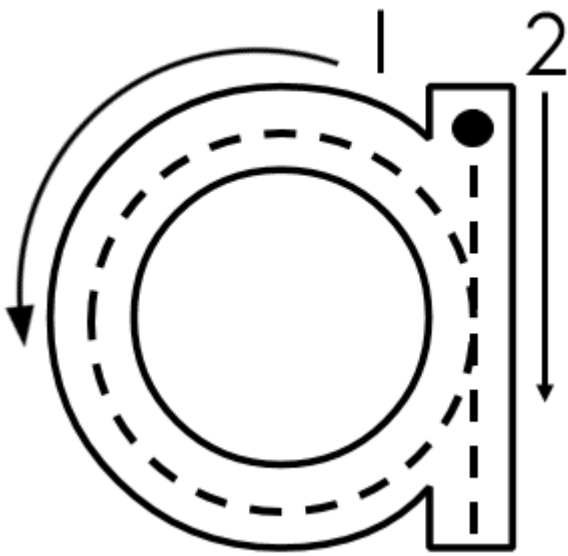

Die letters in my naam is:

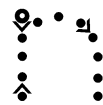
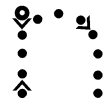
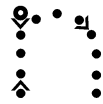
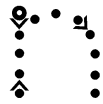
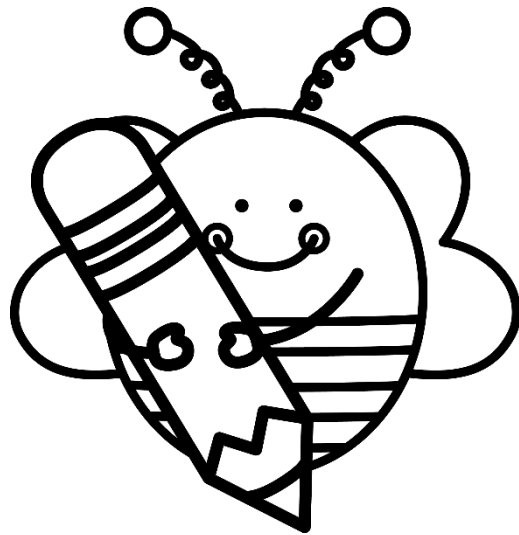
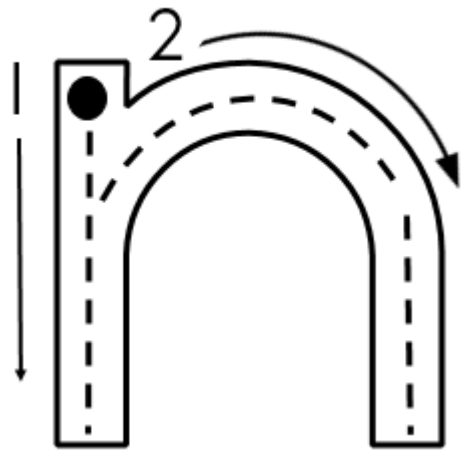

Ek kan my naam skryf in lyntjies

Handwriting practice lines consisting of solid top and bottom lines with a dashed midline, repeated ten times for writing practice.

Nederlander



Nederlander