

Ek leer hoe om
my naam te
SKRYF



My naam is:

Leon

Die eerste letter van my naam is:

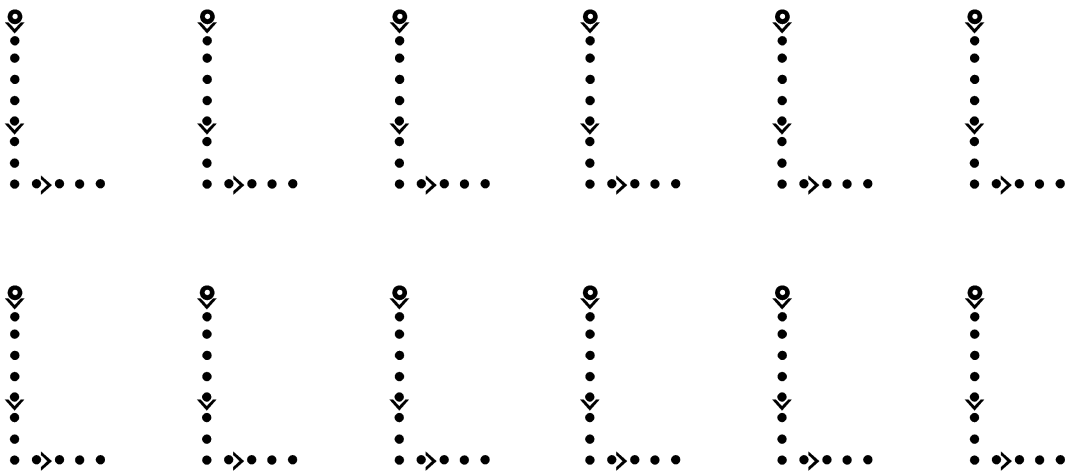
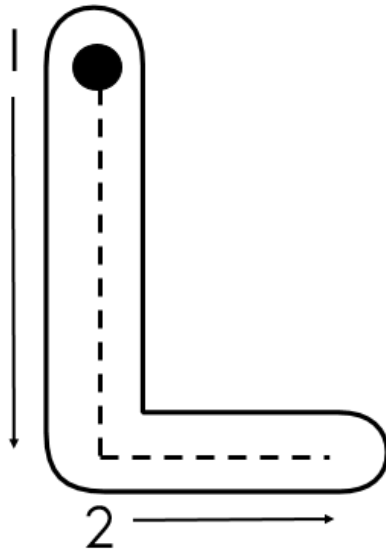

My naam is:

Leed

Leed

Leed

Leed

Leed

My naam is:

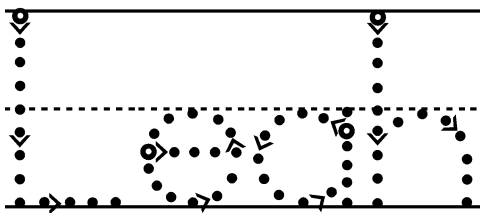
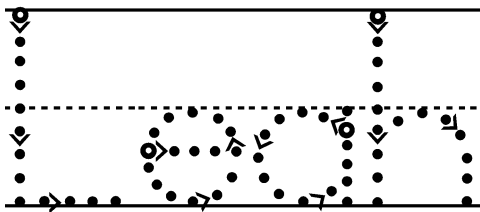
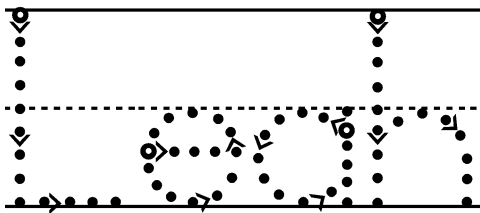
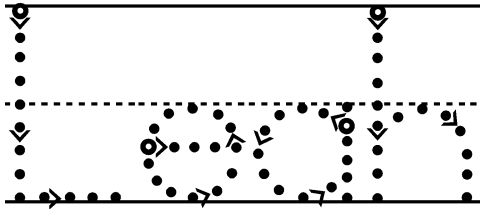
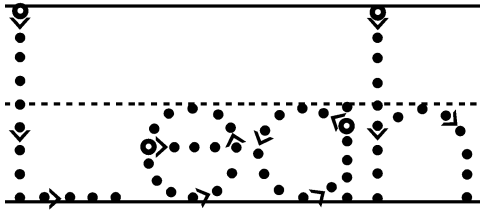

My naam is:

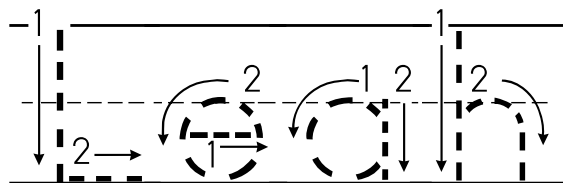
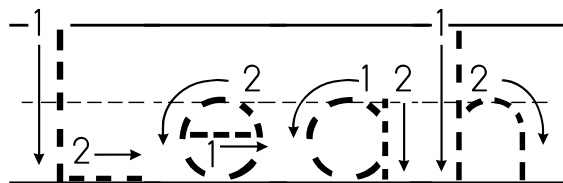
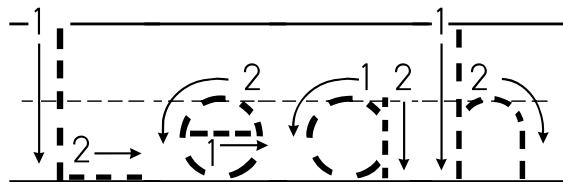
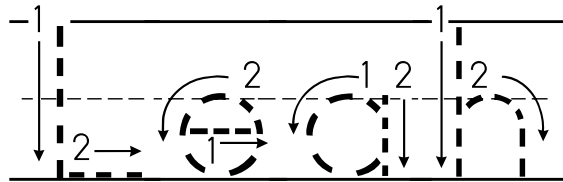
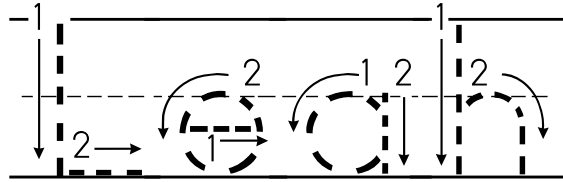

Die letters in my naam is:

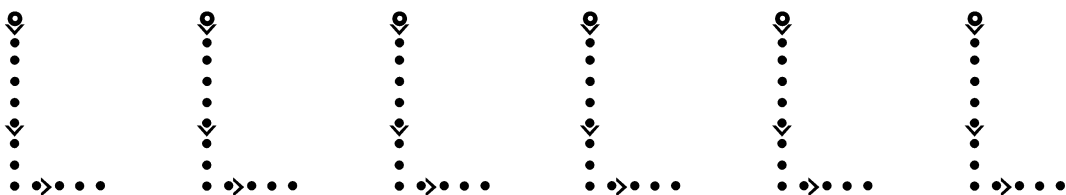
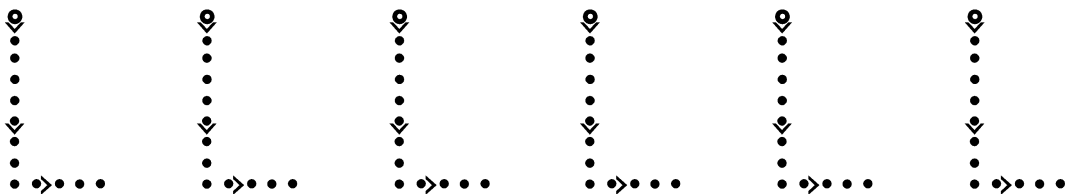
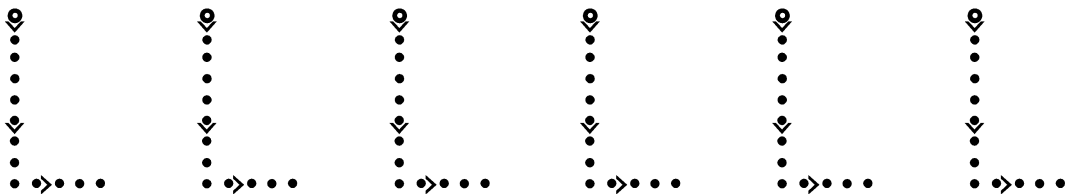
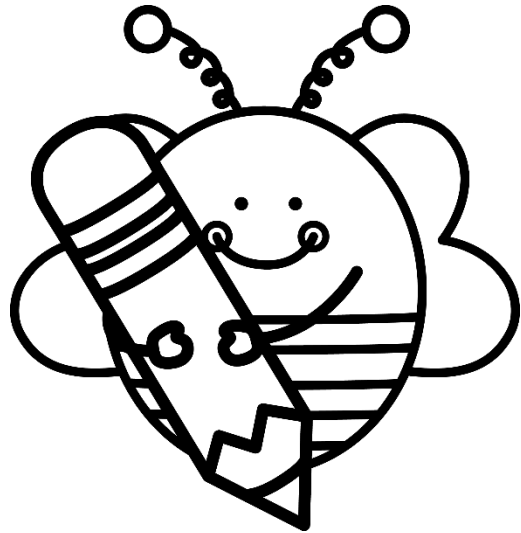
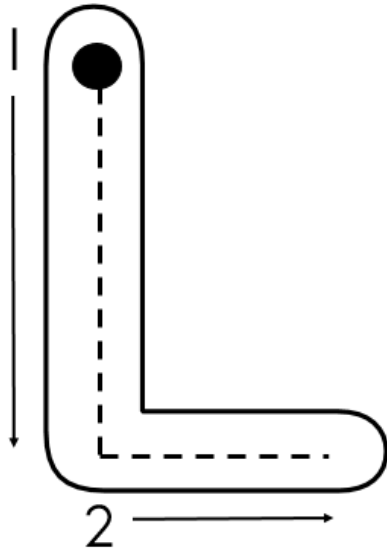

Die letters in my naam is:

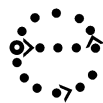
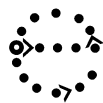
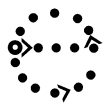
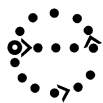
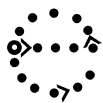
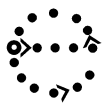
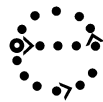
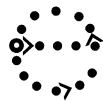
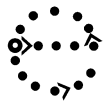
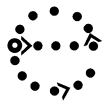
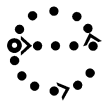
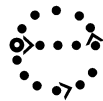
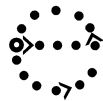
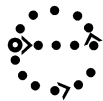
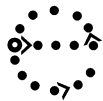
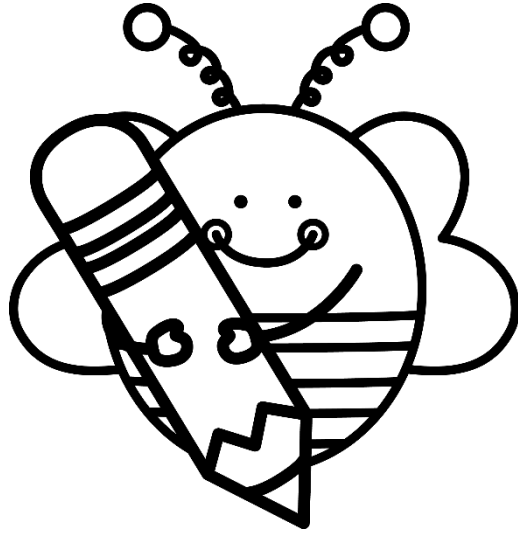
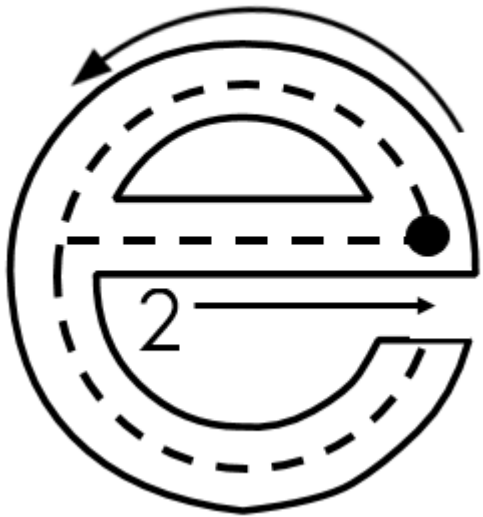

Die letters in my naam is:

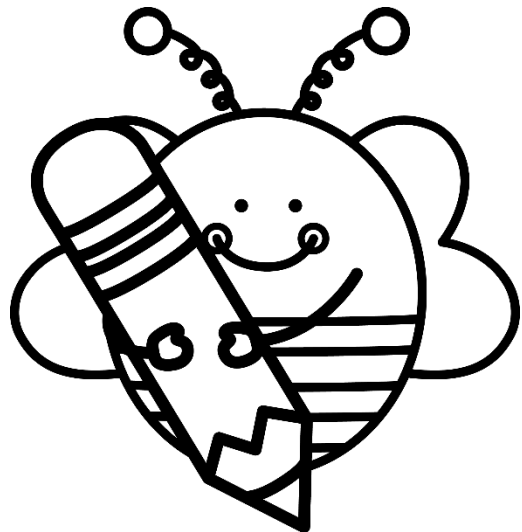
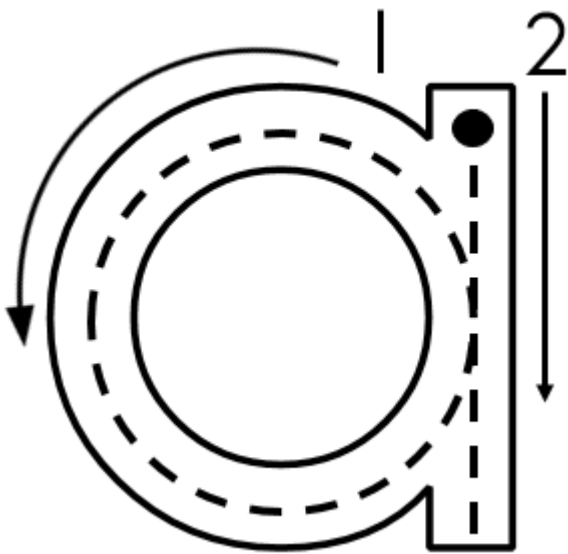

Die letters in my naam is:

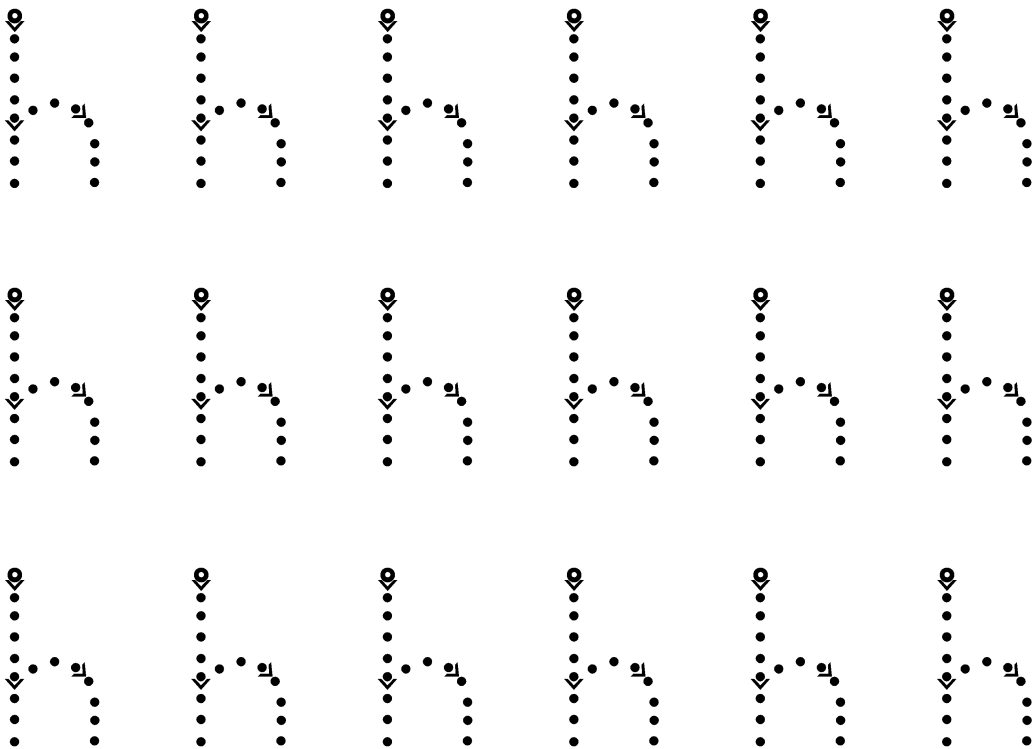
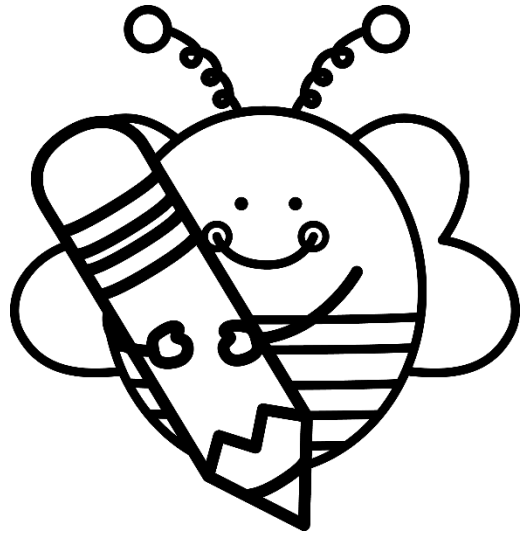
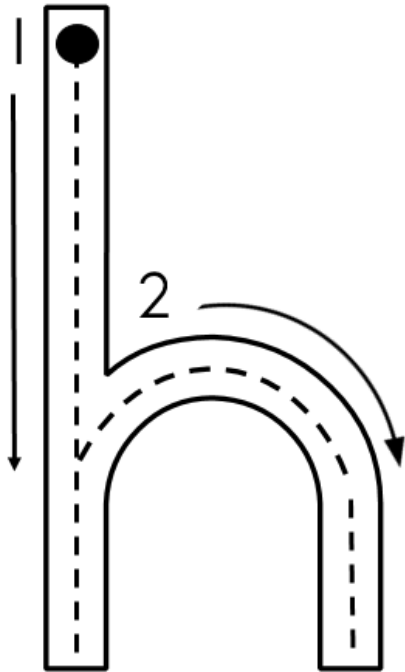

Ek kan my naam skryf in lyntjies

Handwriting practice lines consisting of solid top and bottom lines with a dashed midline, repeated ten times for writing practice.

leer



leer