

Ek leer hoe om

my naam te

SKRYF



Friedrich

My naam is:

Friedrick

Die eerste letter van my naam is:

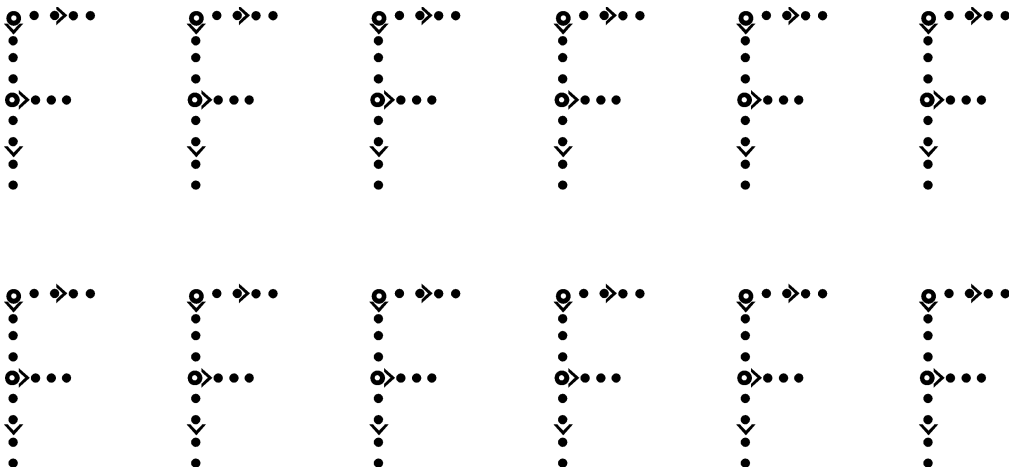
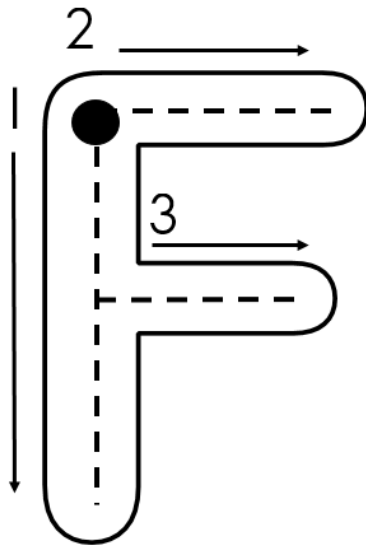

My naam is:

Friedrich

Friedrich

Friedrich

Friedrich

Friedrich

My naam is:

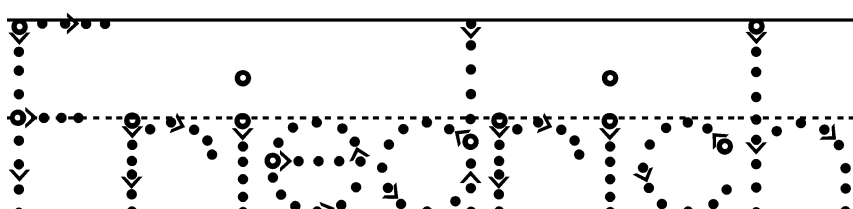
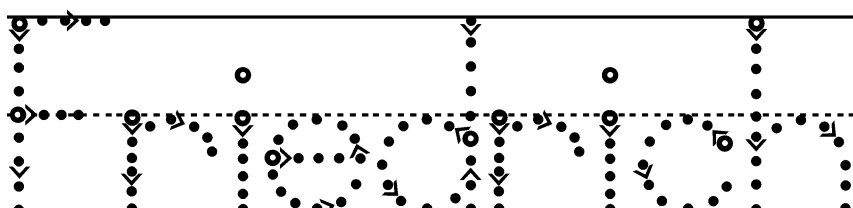
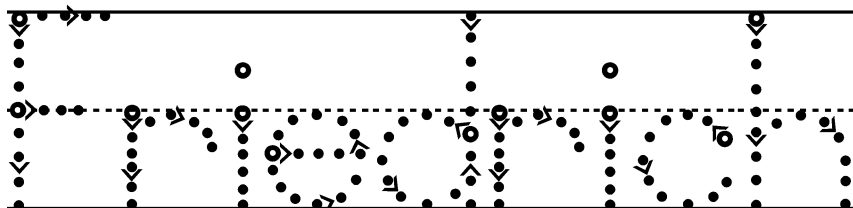
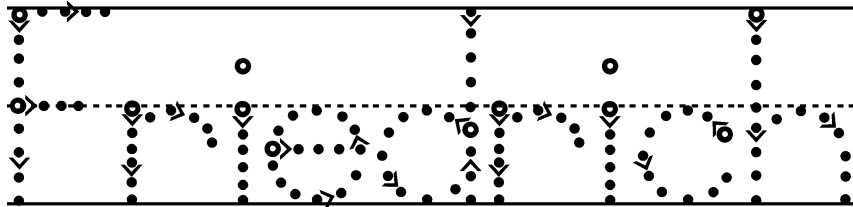
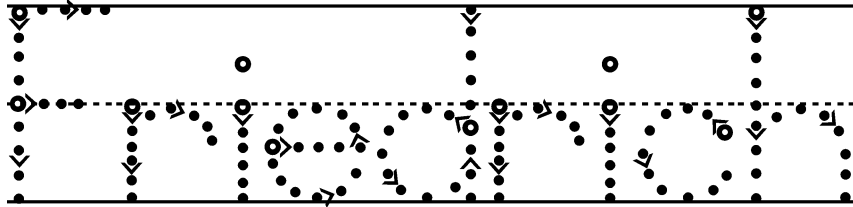

My naam is:

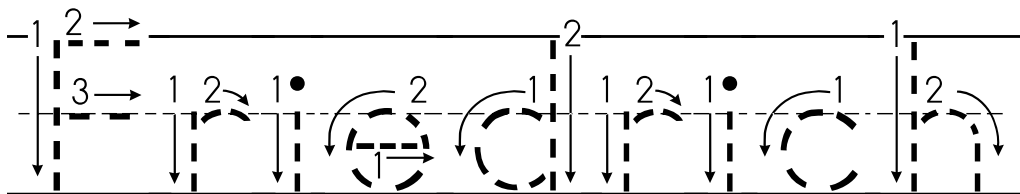
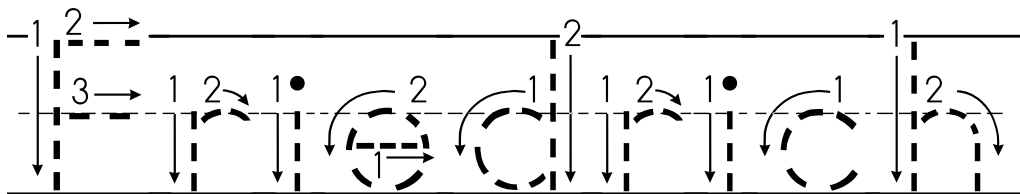
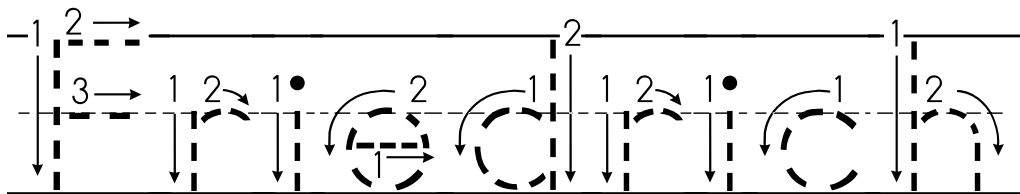
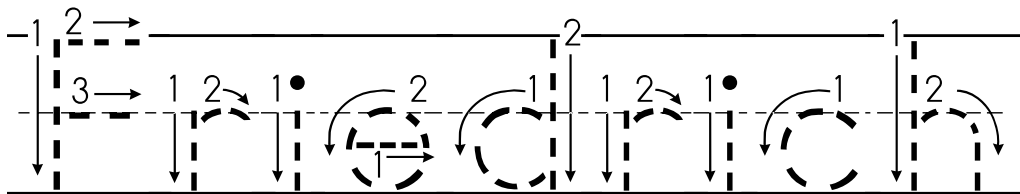
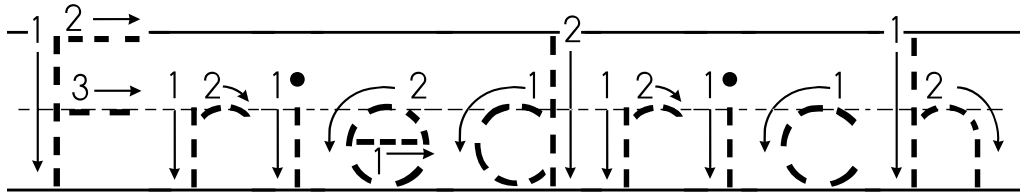

Die letters in my naam is:

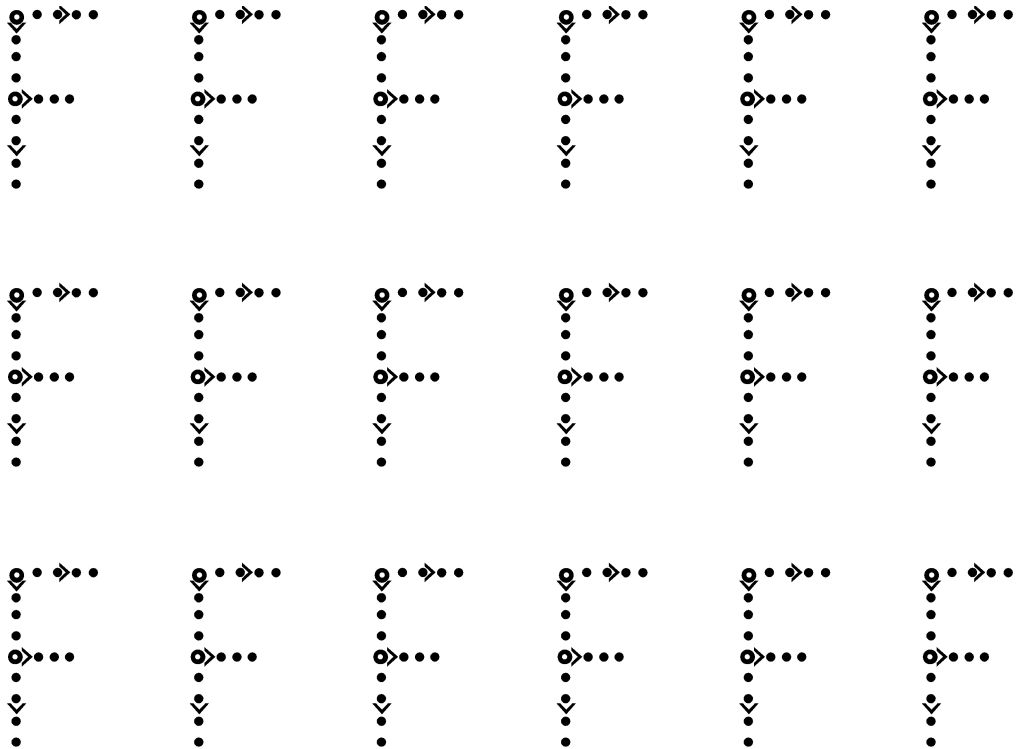
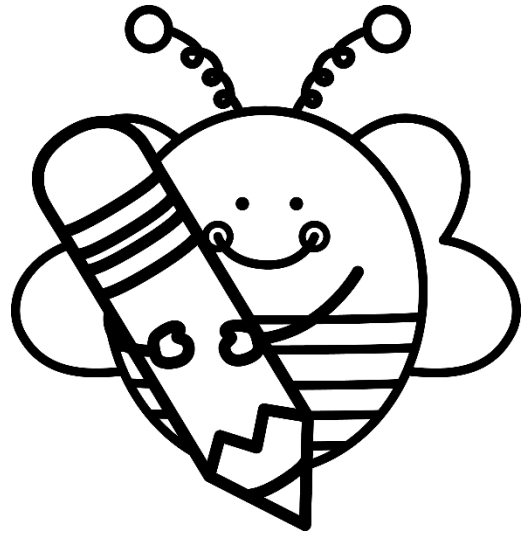
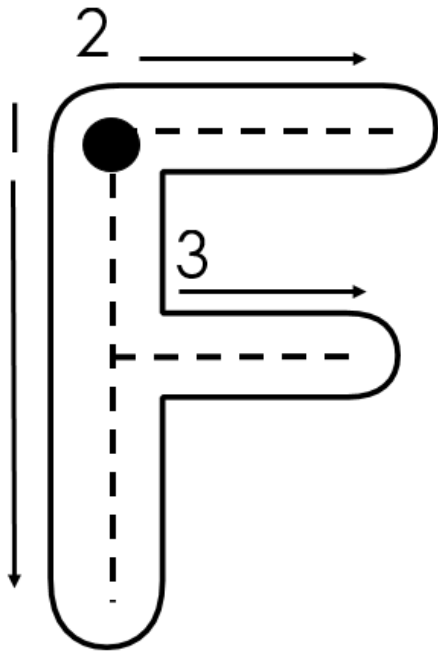

Die letters in my naam is:

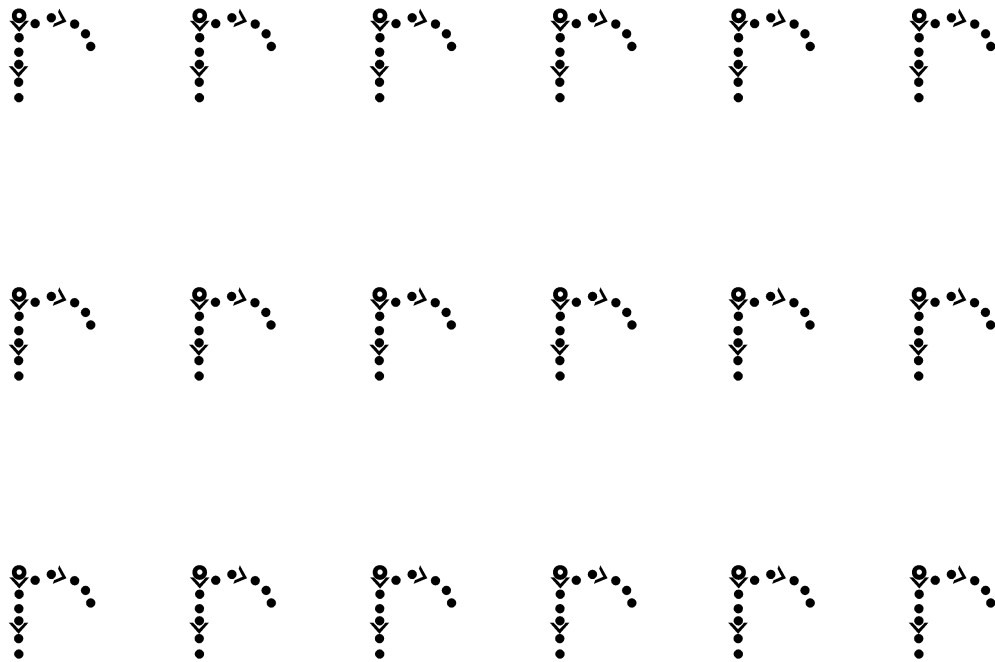
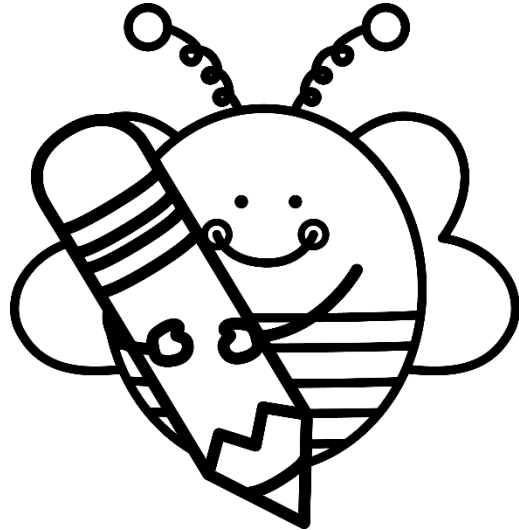
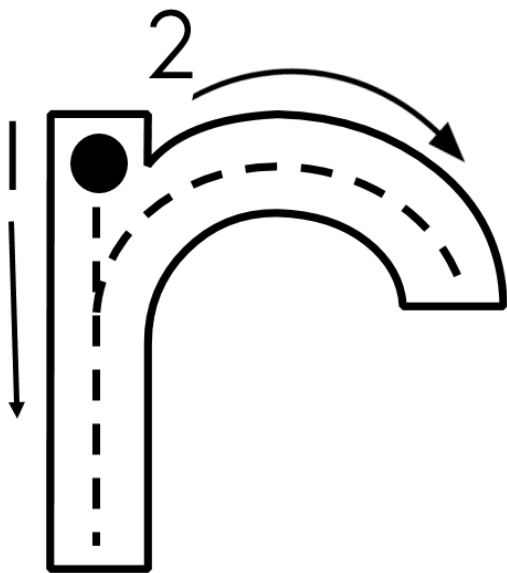

Die letters in my naam is:

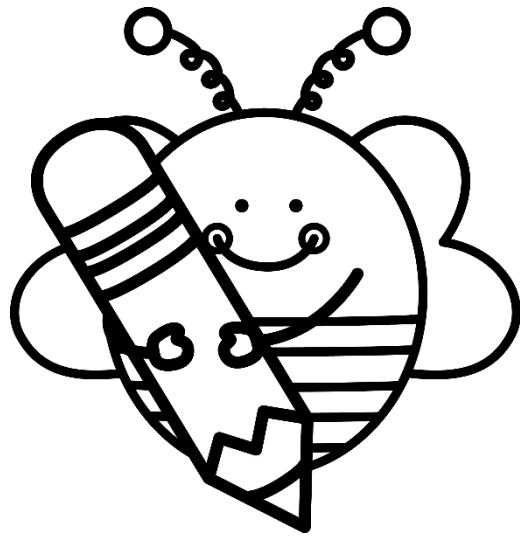

.....oooooo
.....oooooo
.....oooooo

Die letters in my naam is:

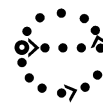
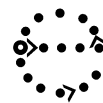
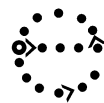
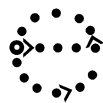
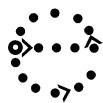
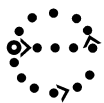
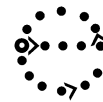
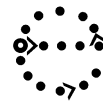
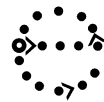
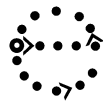
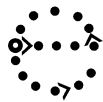
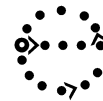
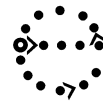
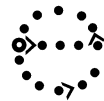
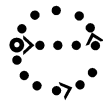
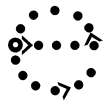
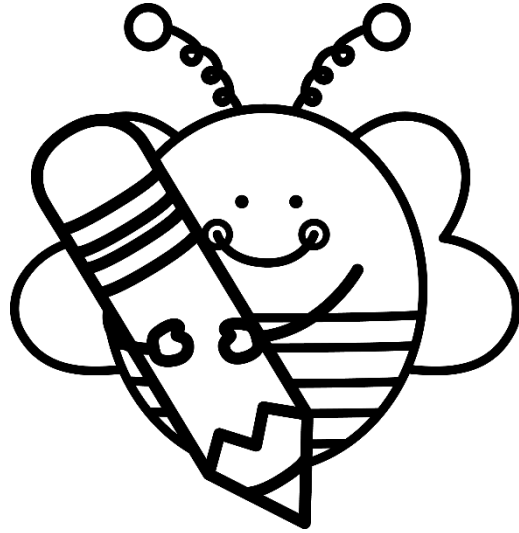
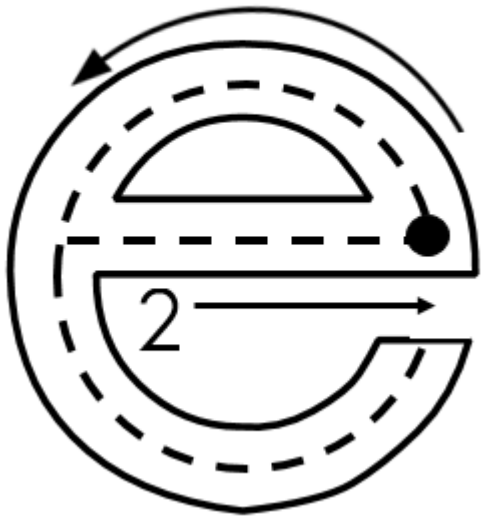

Die letters in my naam is:

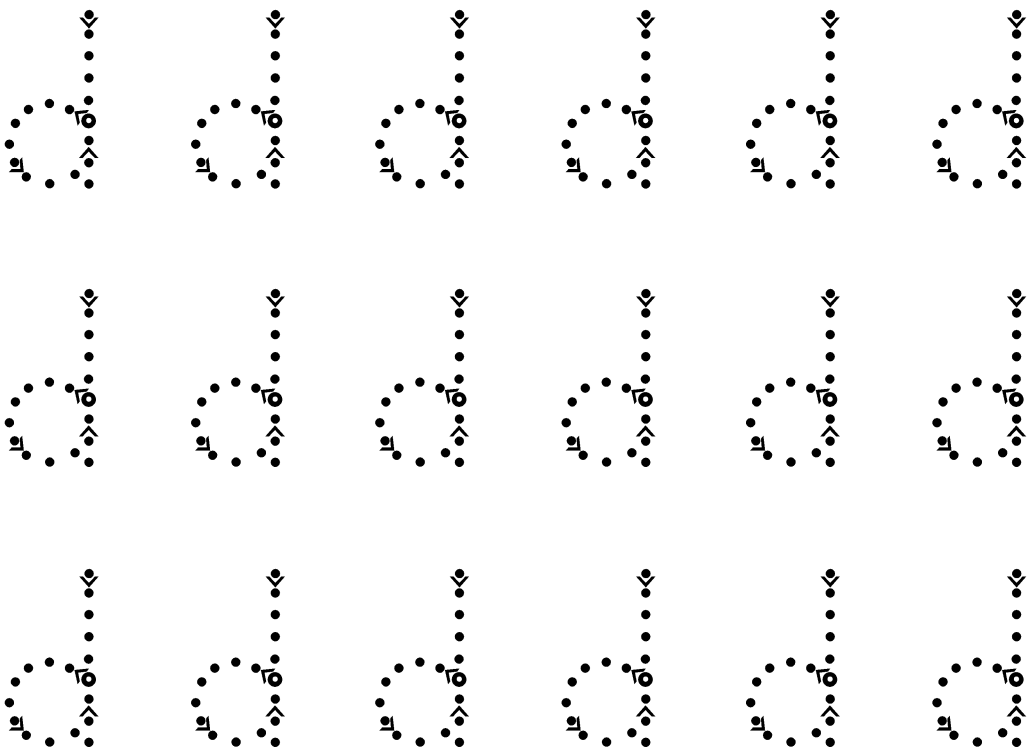
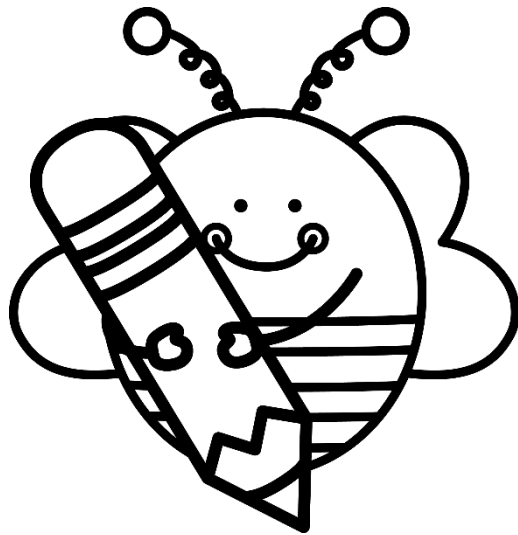
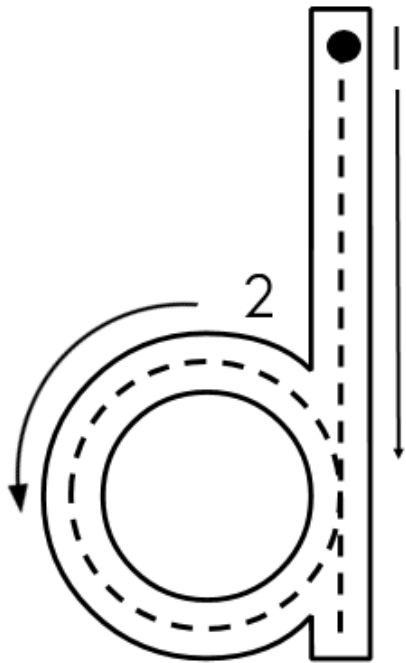

Die letters in my naam is:

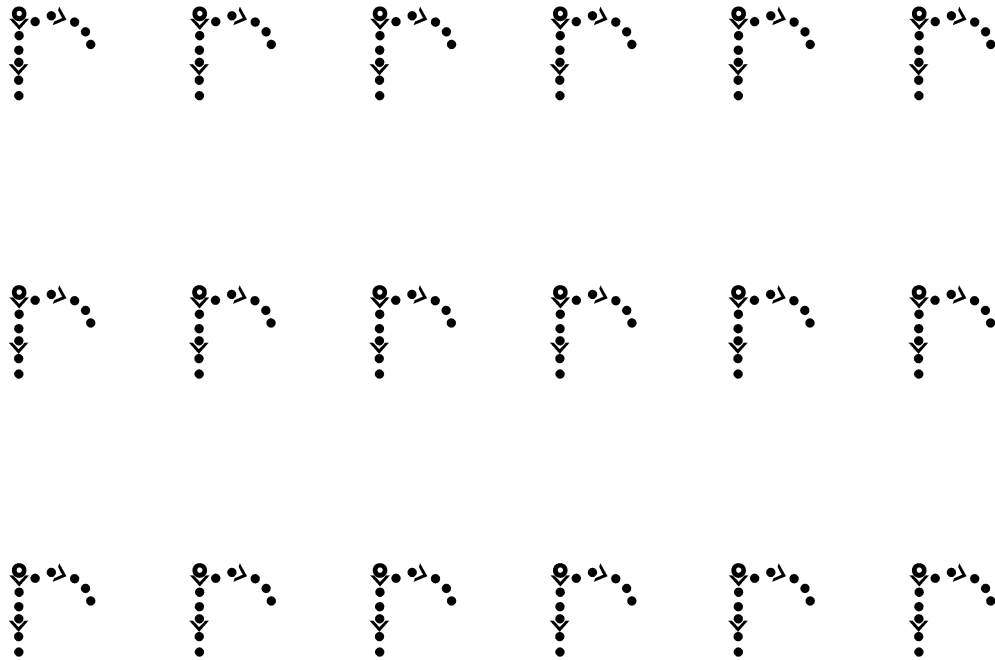
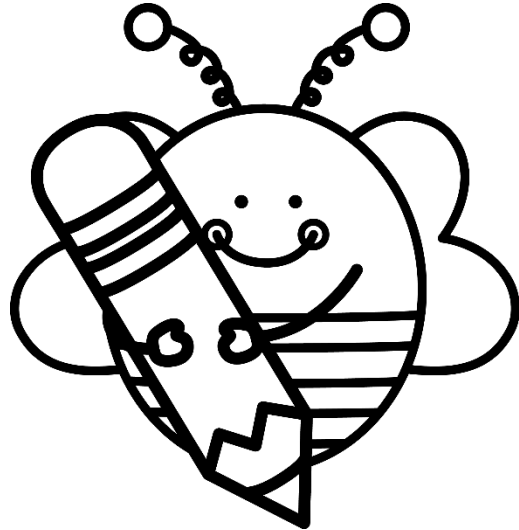
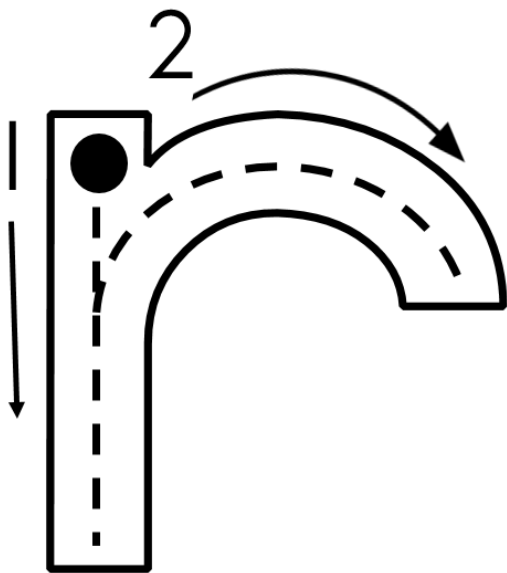

Die letters in my naam is:

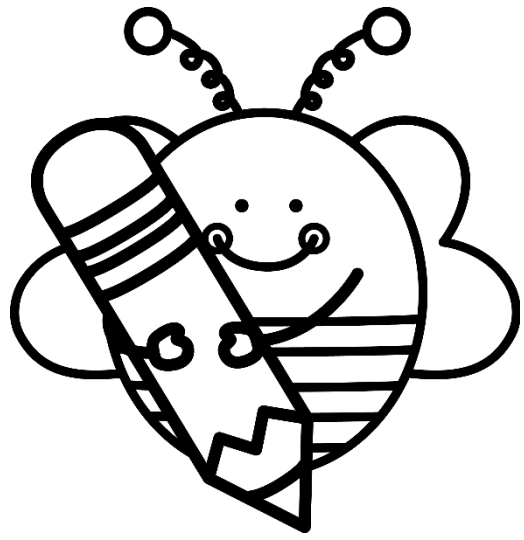

.....oooooo
.....oooooo
.....oooooo

Die letters in my naam is:

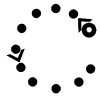
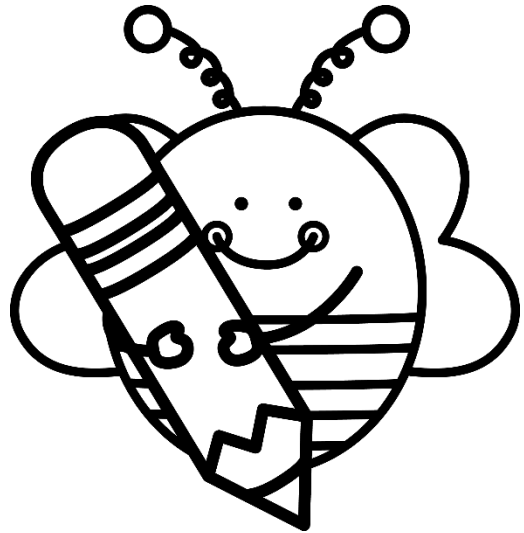
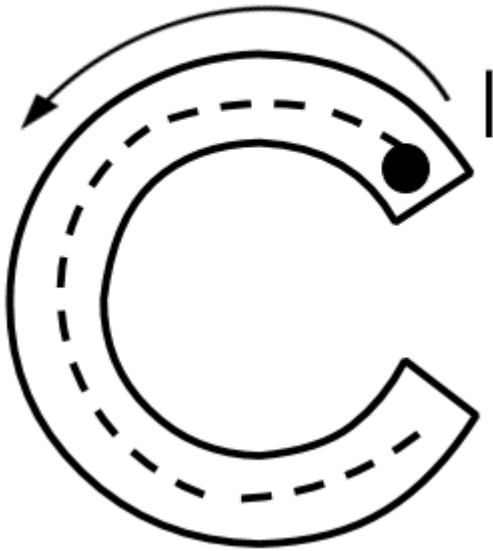

Die letters in my naam is:

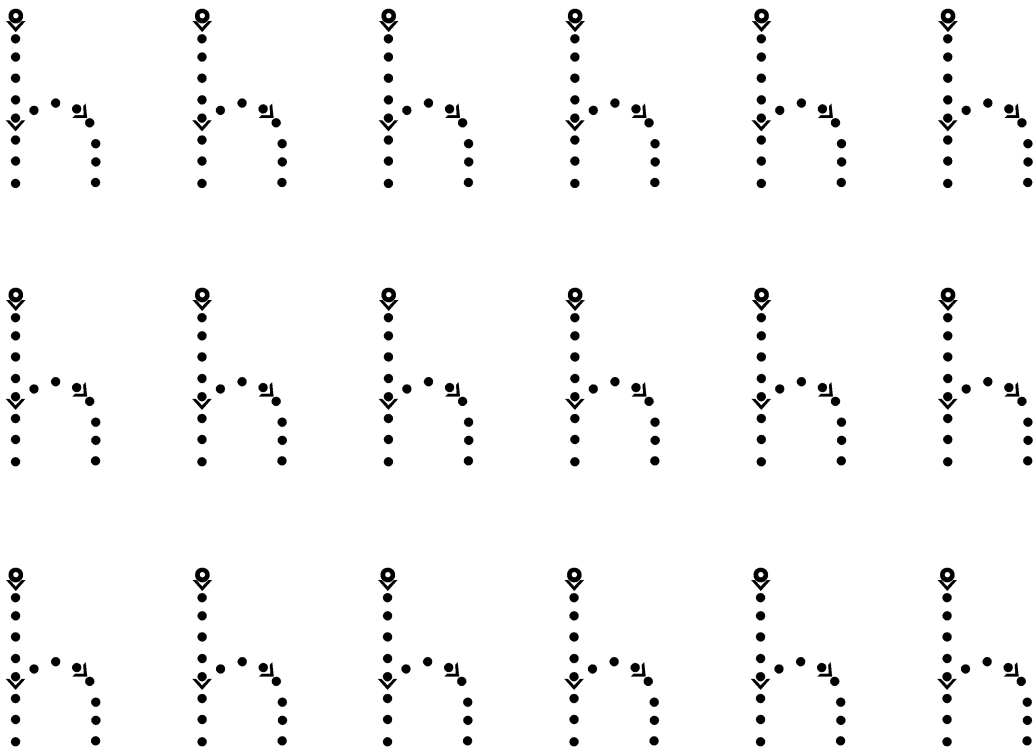
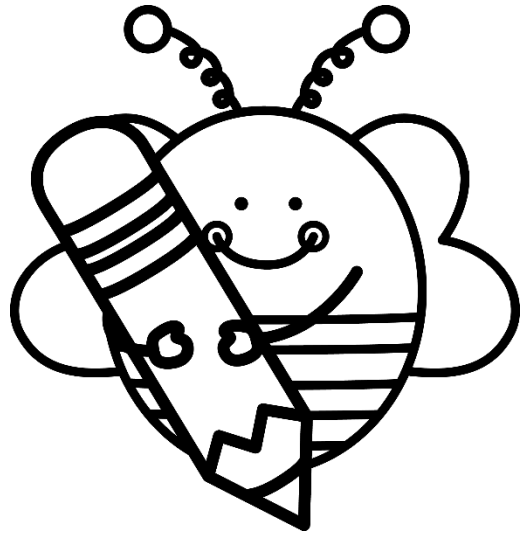
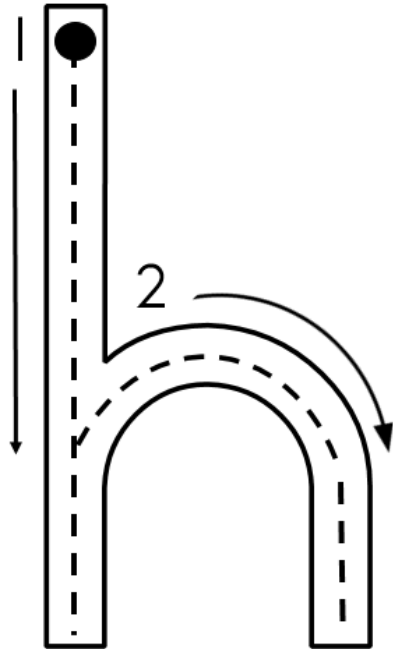

Ek kan my naam skryf in lyntjies

Handwriting practice lines consisting of ten sets of three horizontal lines (top solid, middle dashed, bottom solid) for writing a name.

Friedrich



Friedrich

Friedrich