

Three sets of horizontal lines for writing practice. Each set consists of a top line, a middle line, and a bottom line. The first set contains a dotted lowercase letter 'q' for tracing, while the other two sets are blank.

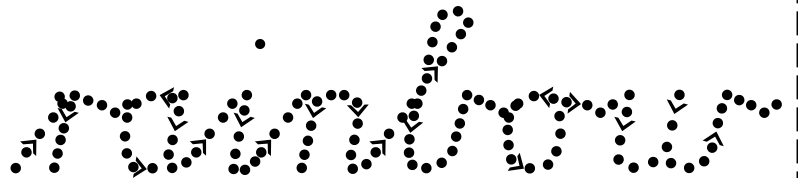

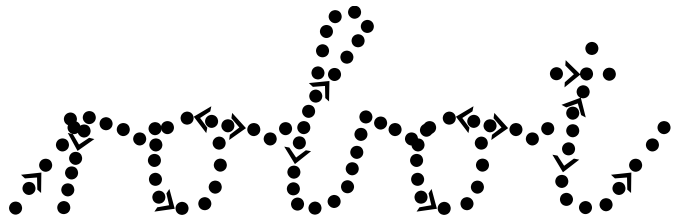

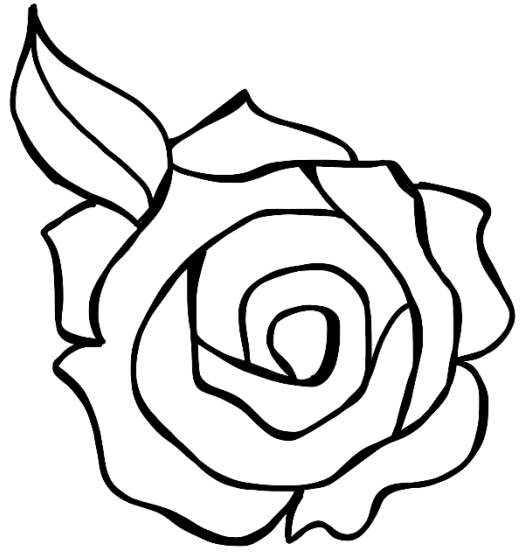

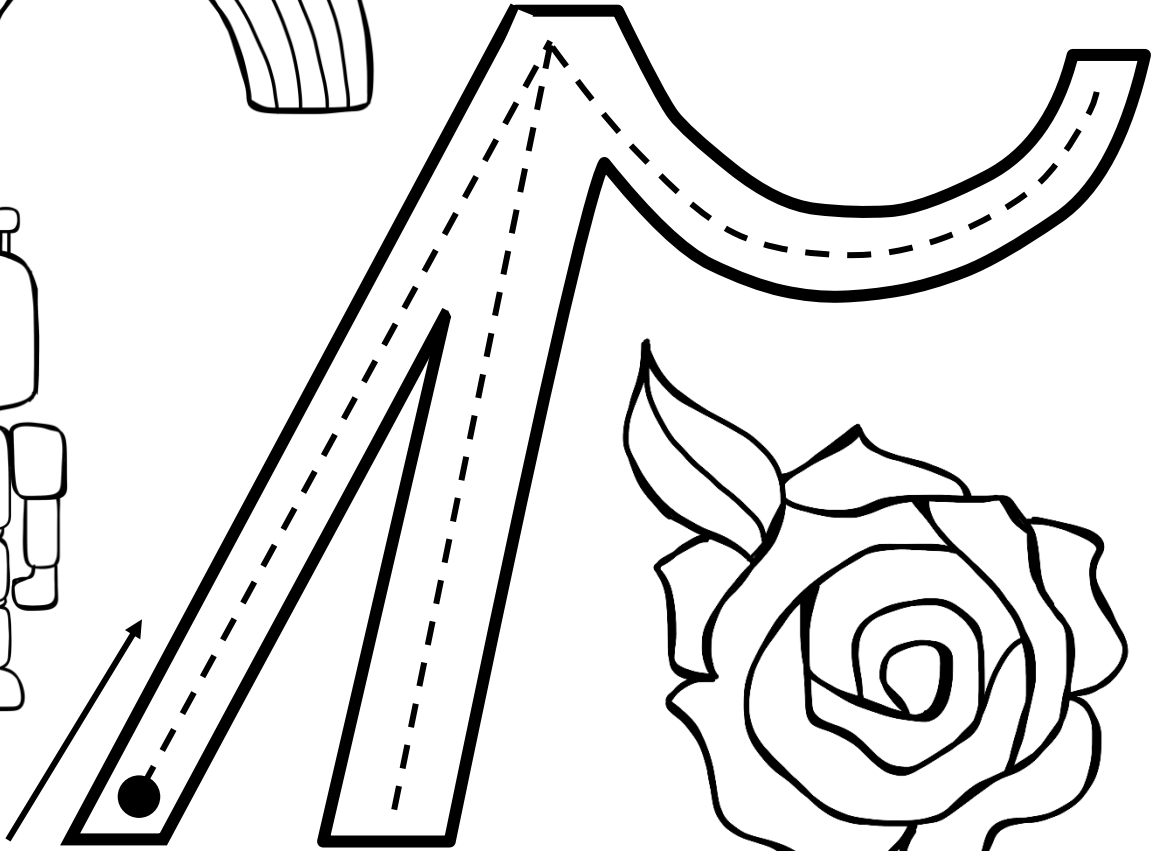
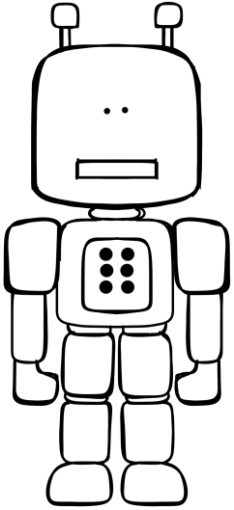
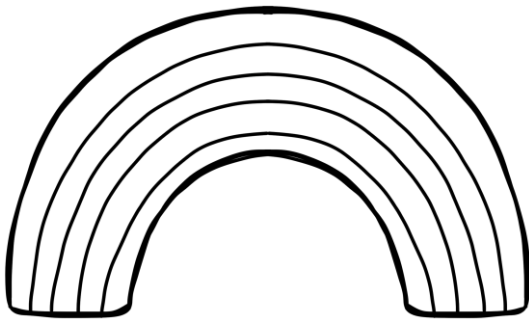
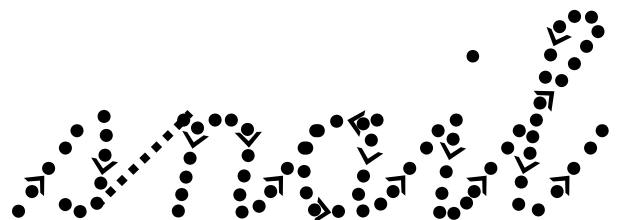
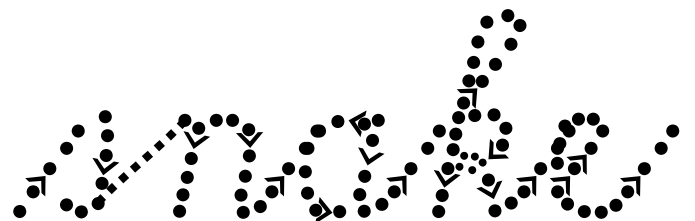
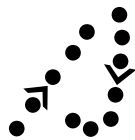
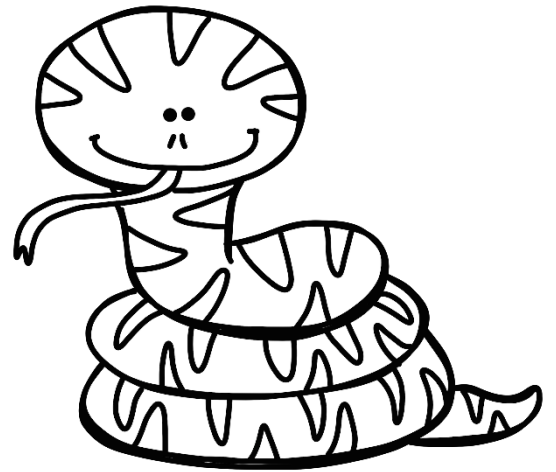
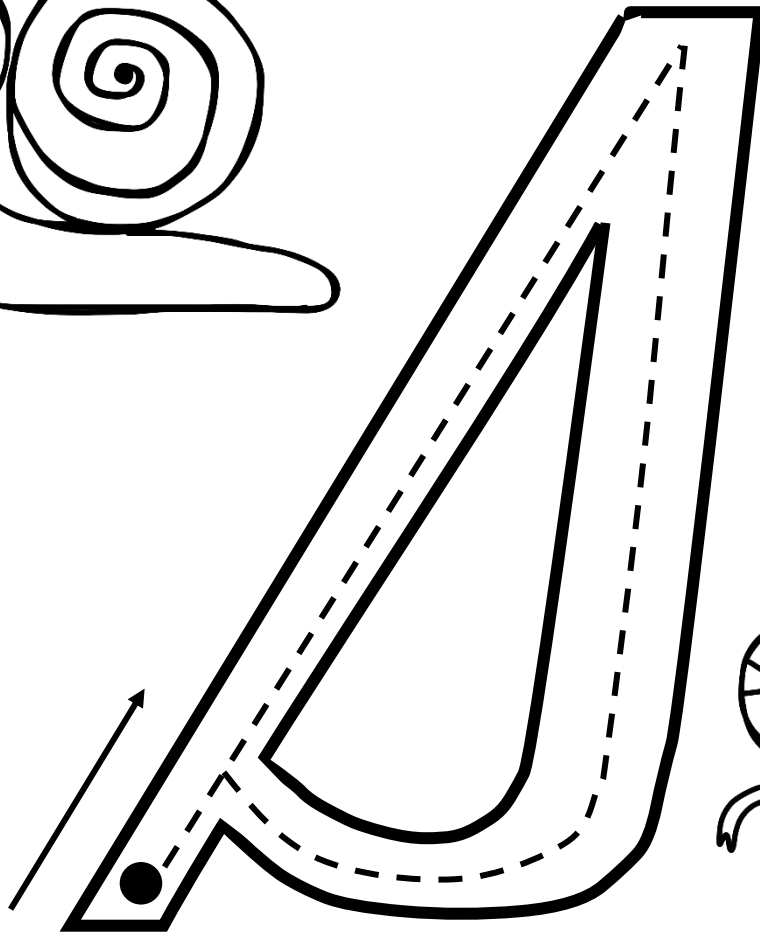
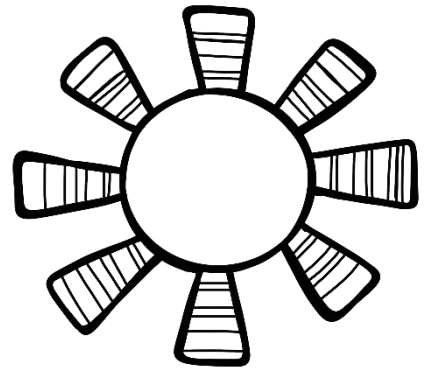
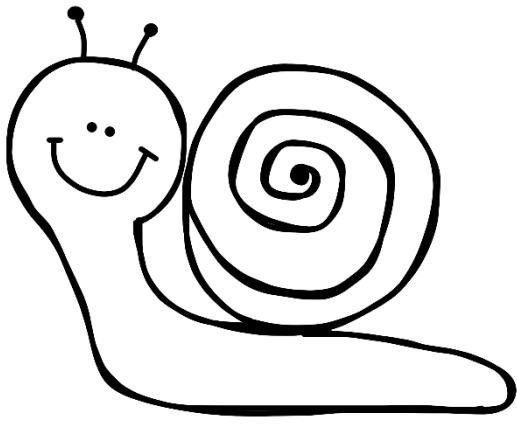
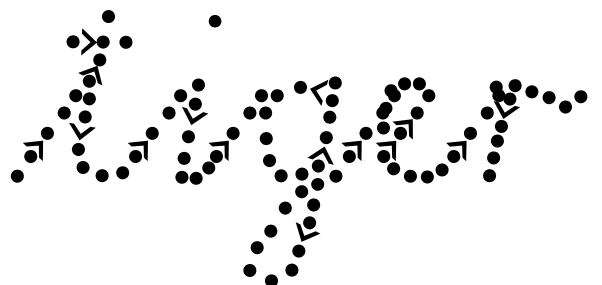
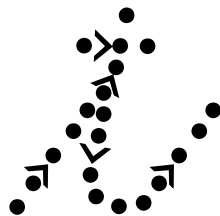
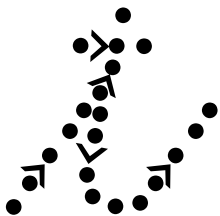
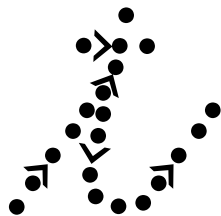
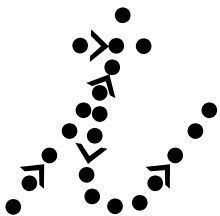
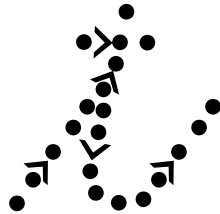
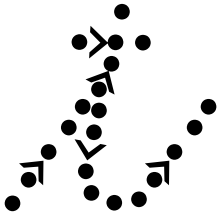
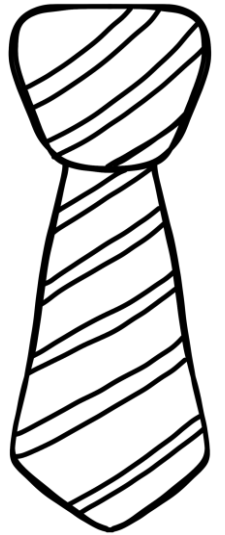
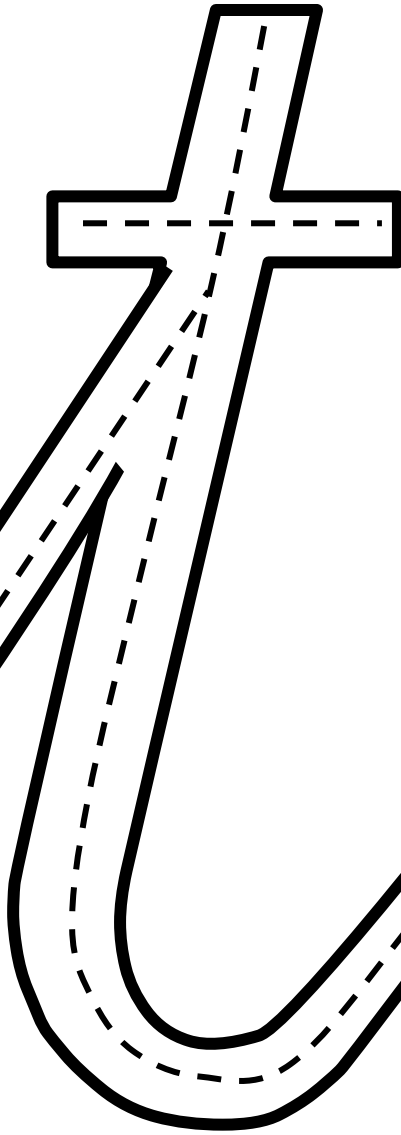
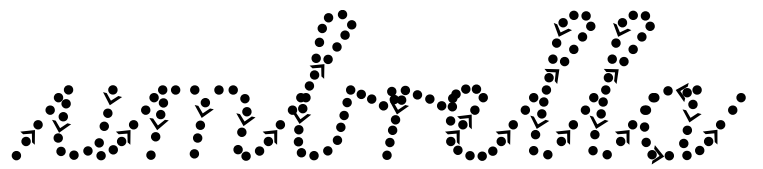
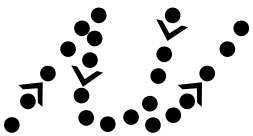
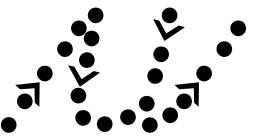
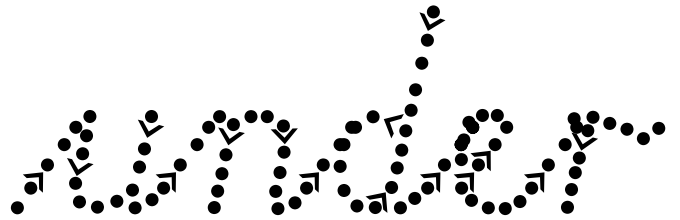
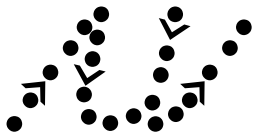
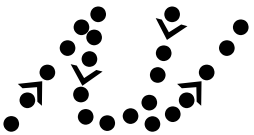
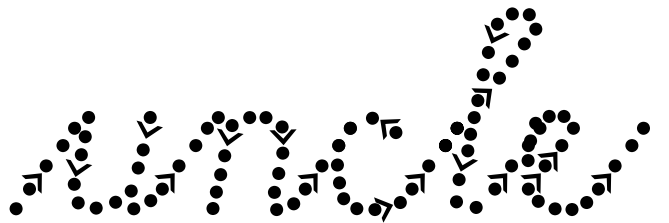
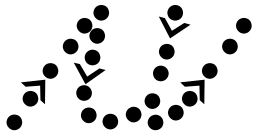
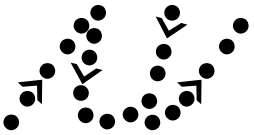
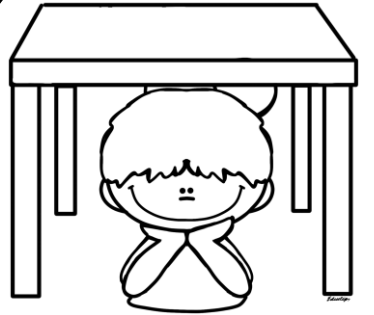
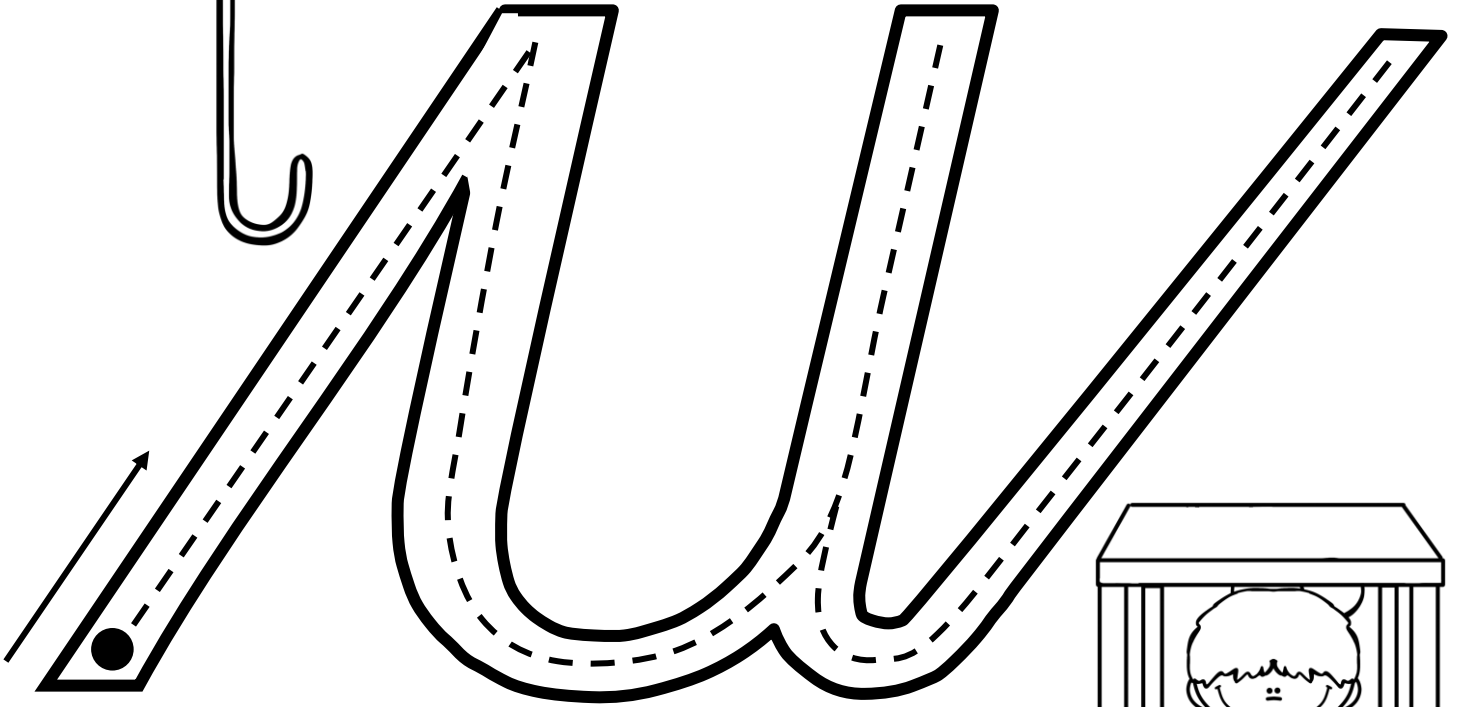

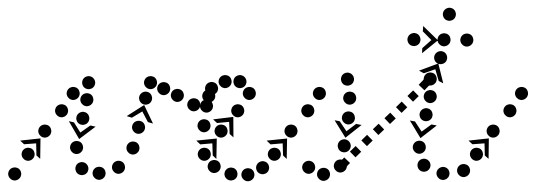
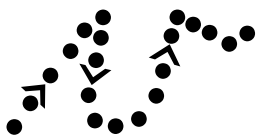
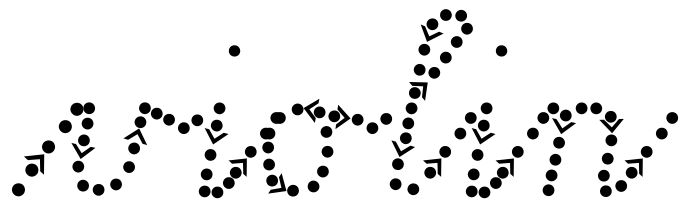
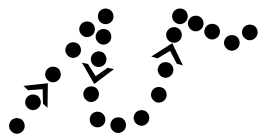
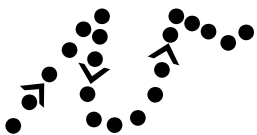
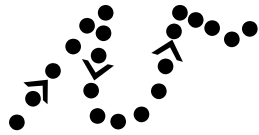
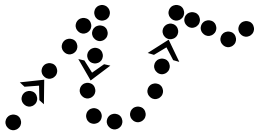
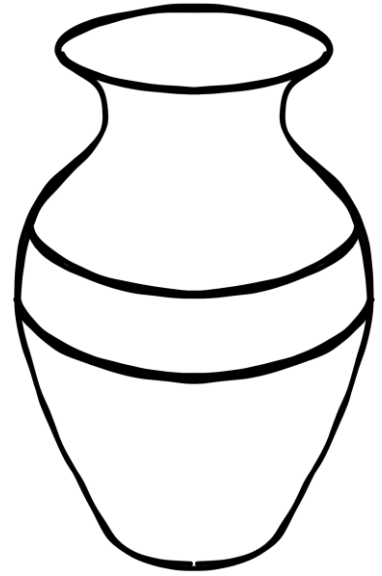
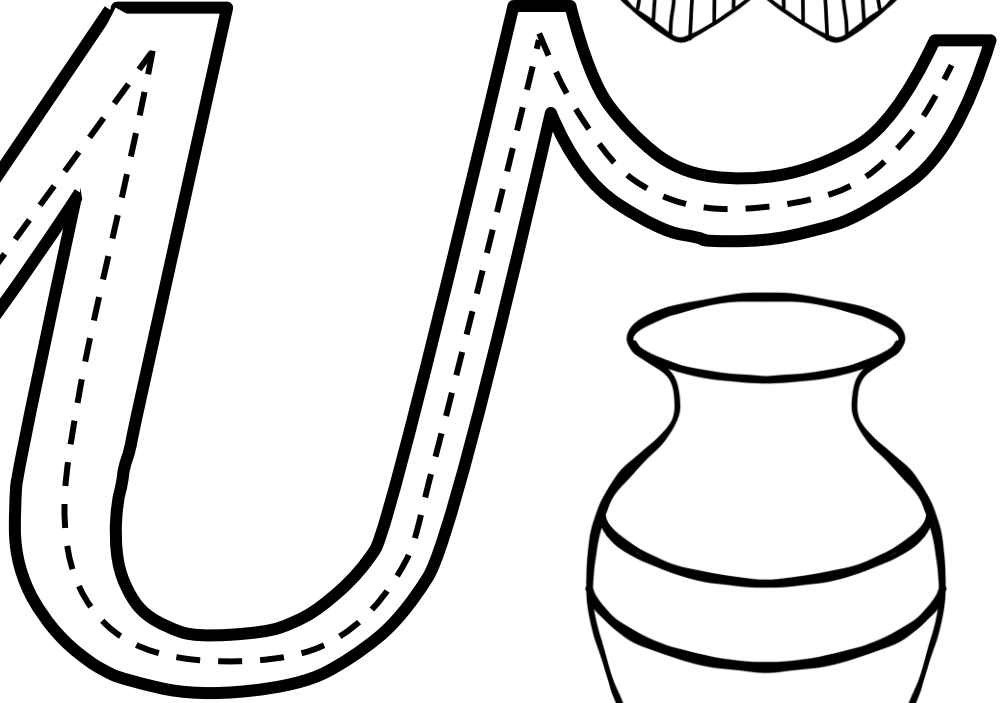
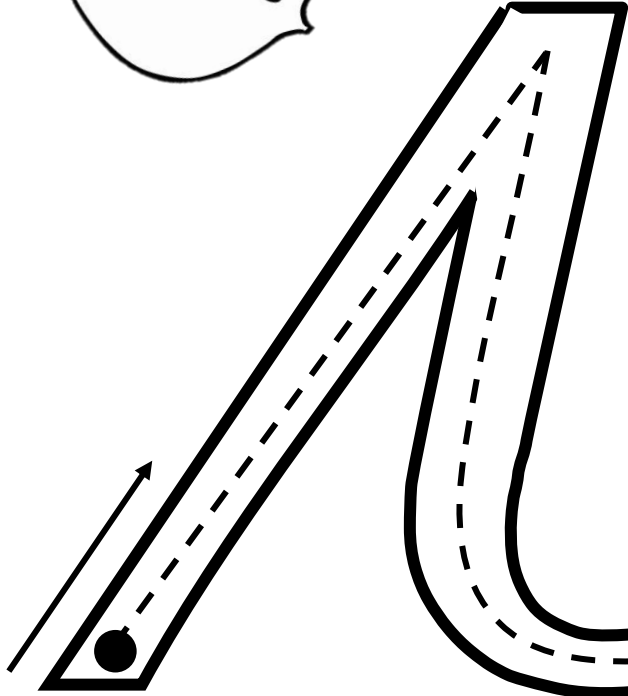
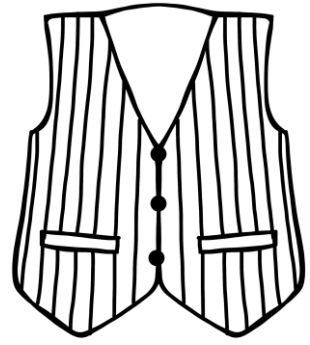

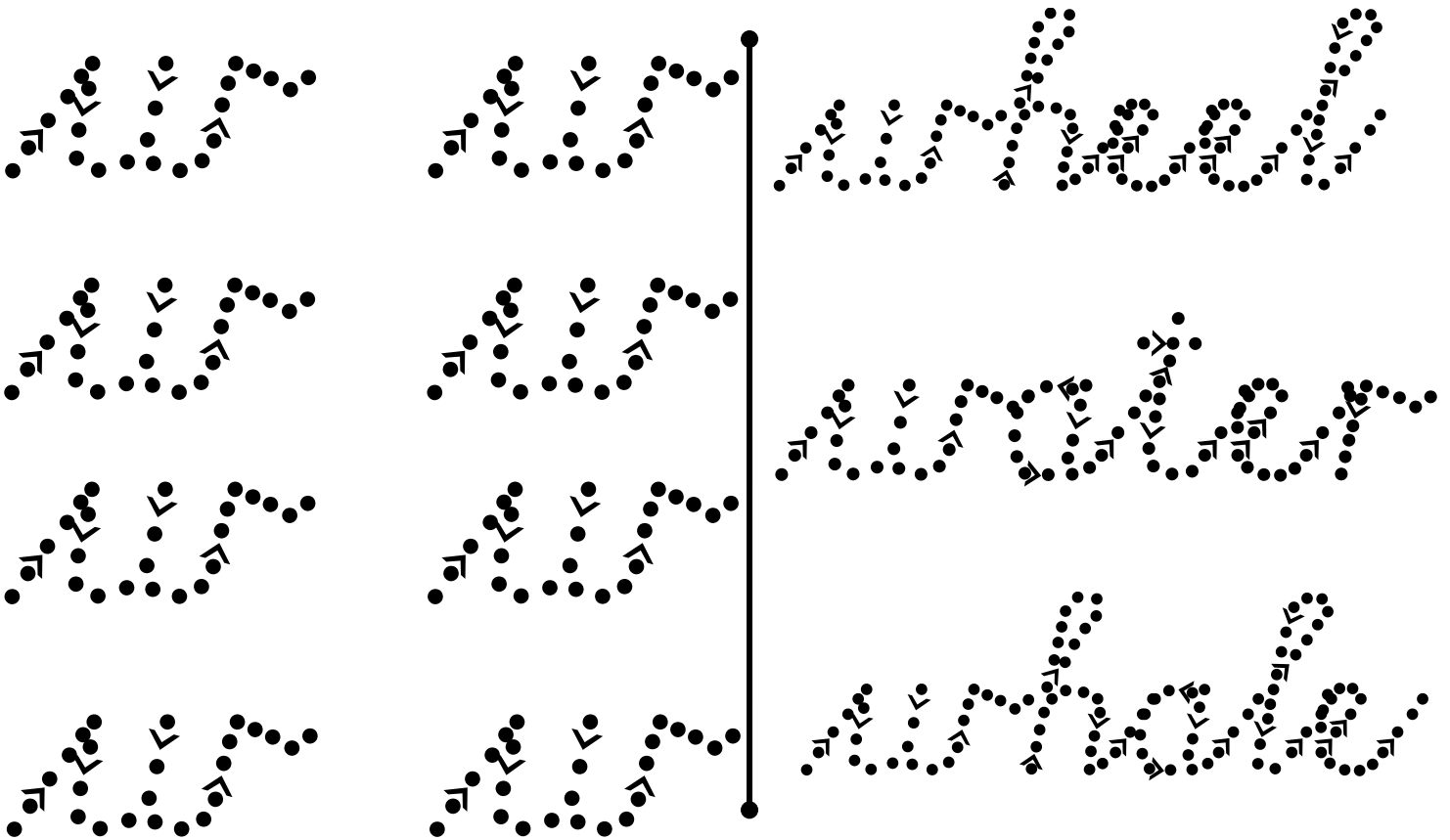
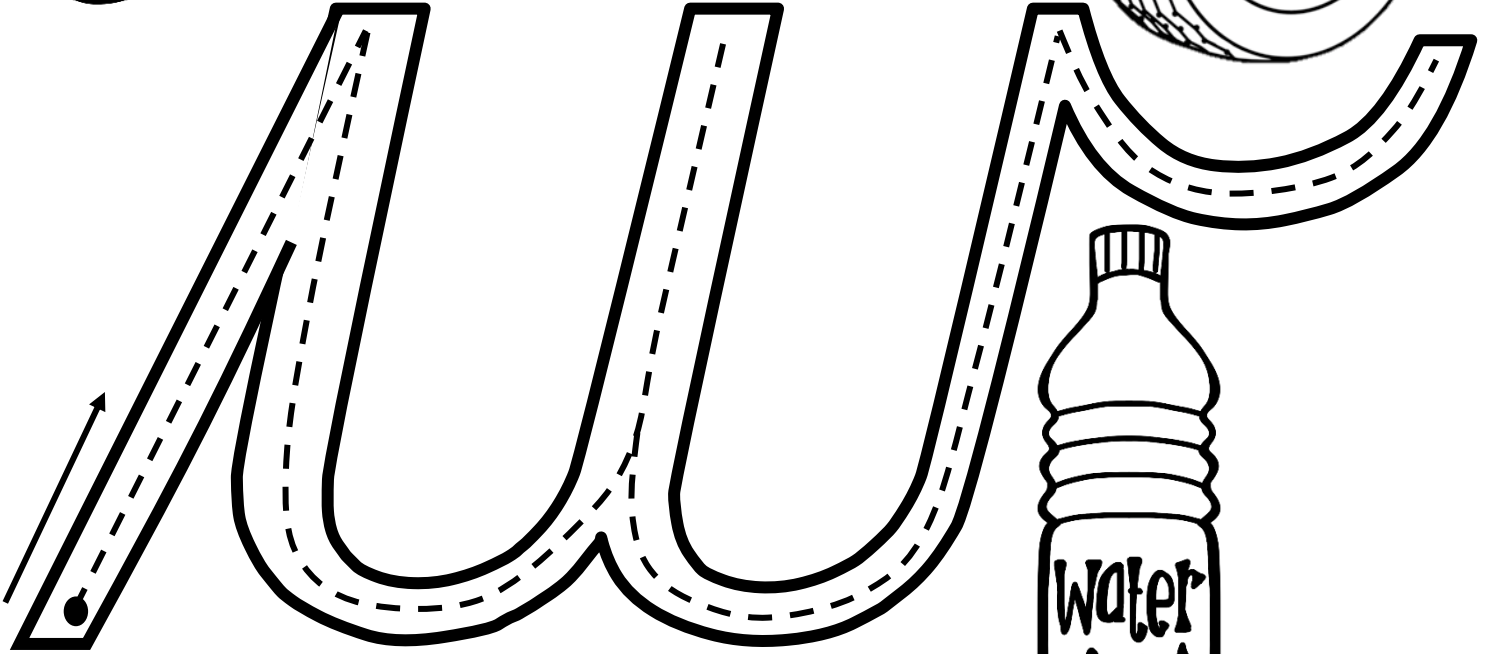
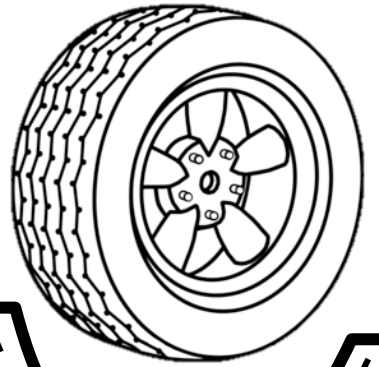
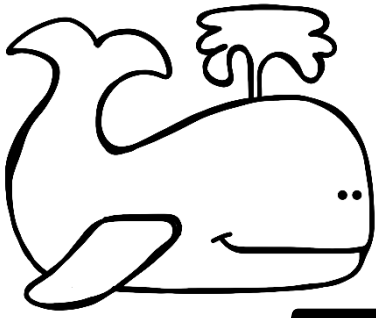



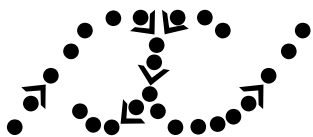
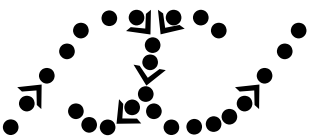
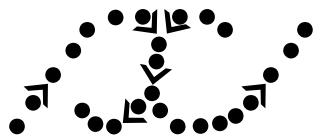
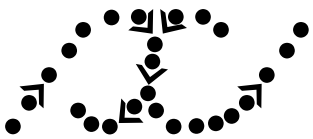
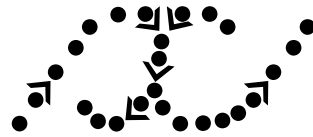
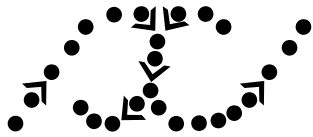
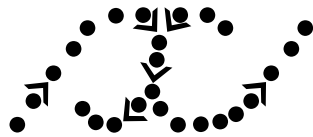
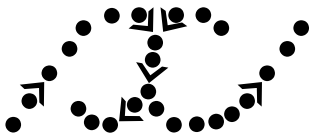
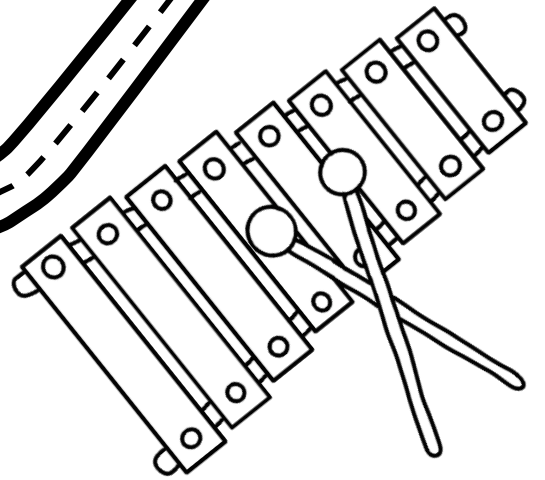
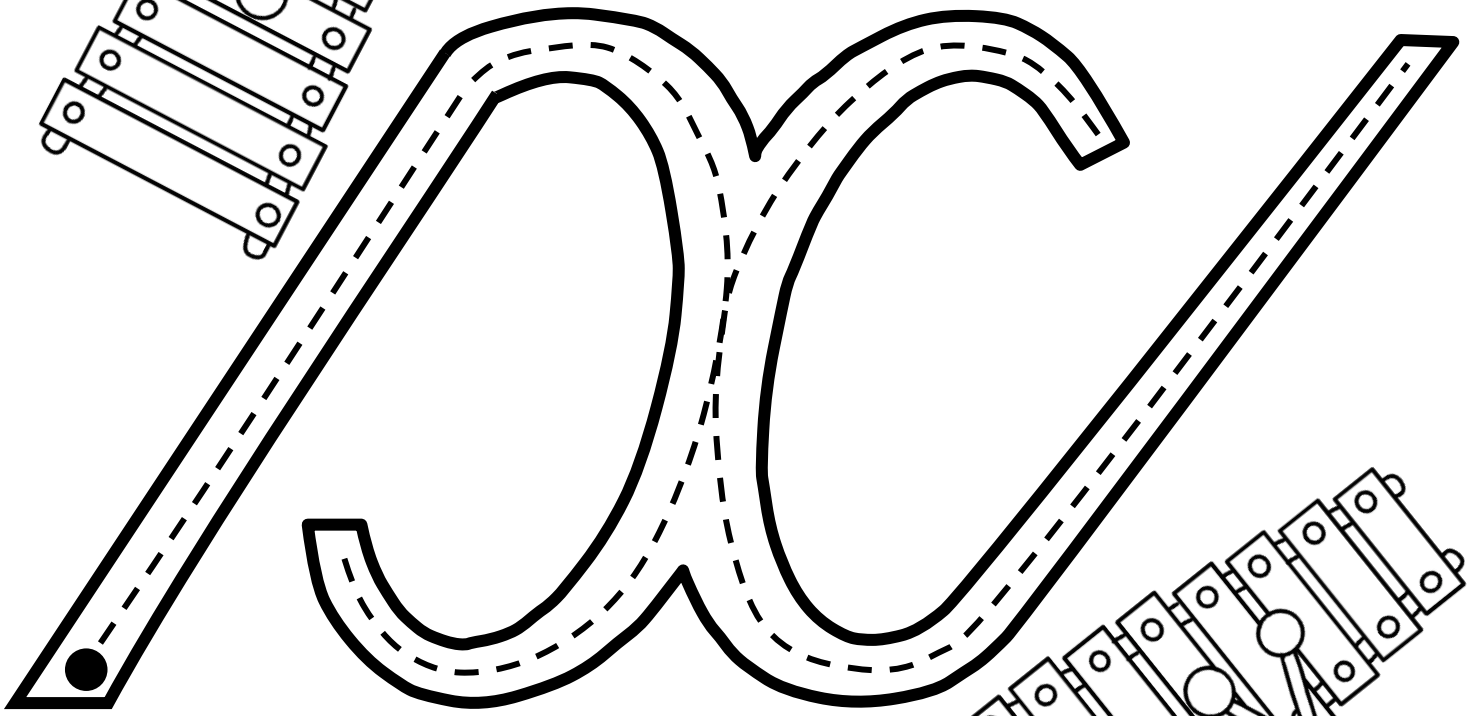
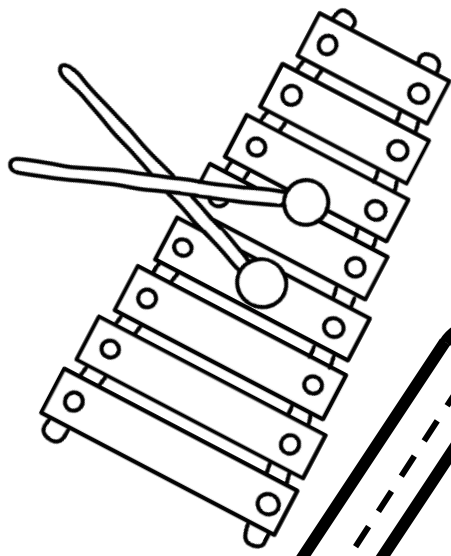

A vertical line on the left side of the writing section. To its right are four horizontal lines for writing. The first three lines contain a dotted letter 'a' for tracing. The fourth line contains the word 'aylona home' written in a dotted, cursive font.

