

3 - 4 jariges

Pret pakkie

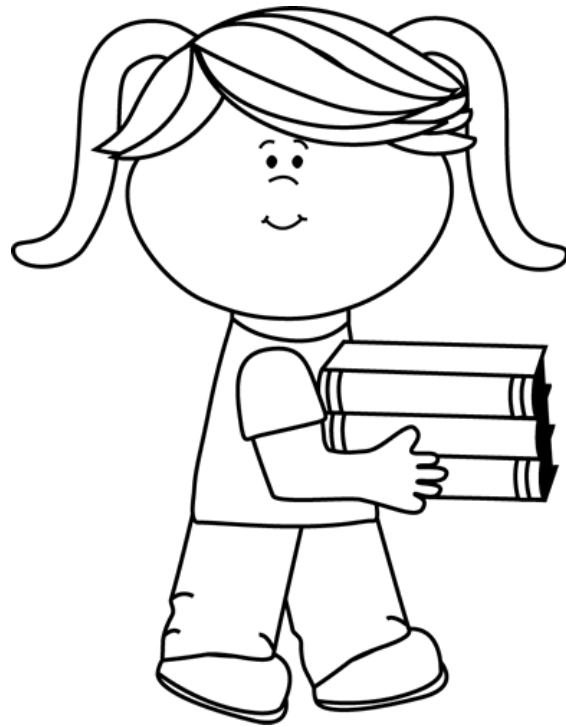

Naam:

Help Skillie skilpad om
op die ballonne se
stippellyne te knip

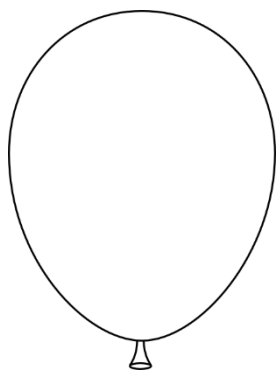
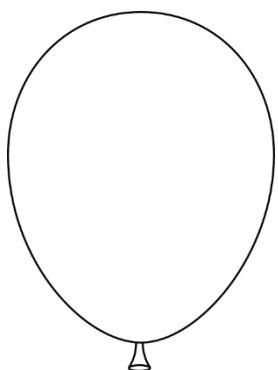
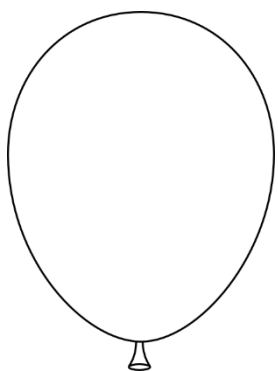
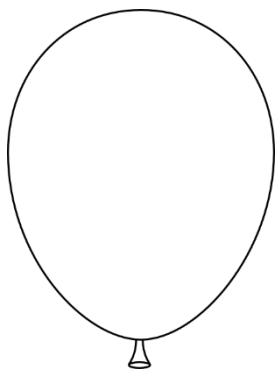
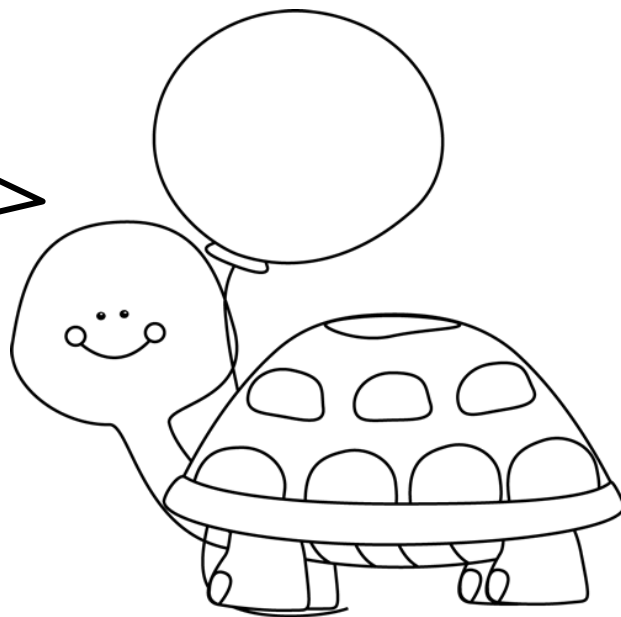

Kom ons knip!

Knip die vierkant uit

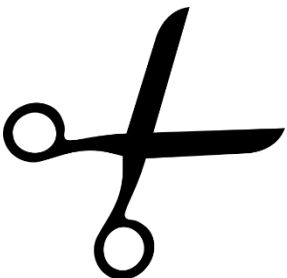
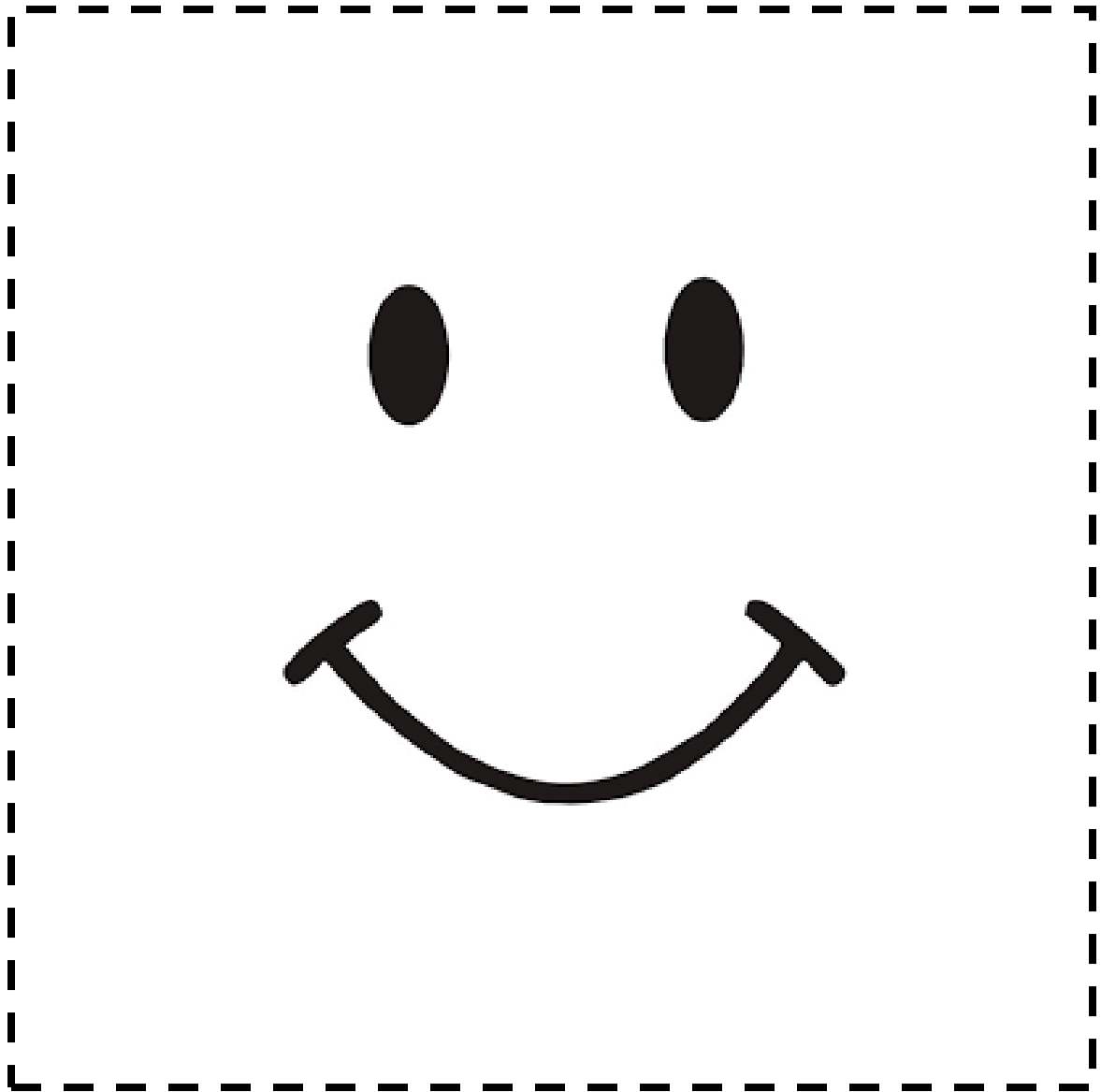

Kom ons knip!

Knip die sirkel uit

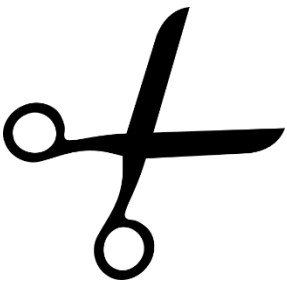
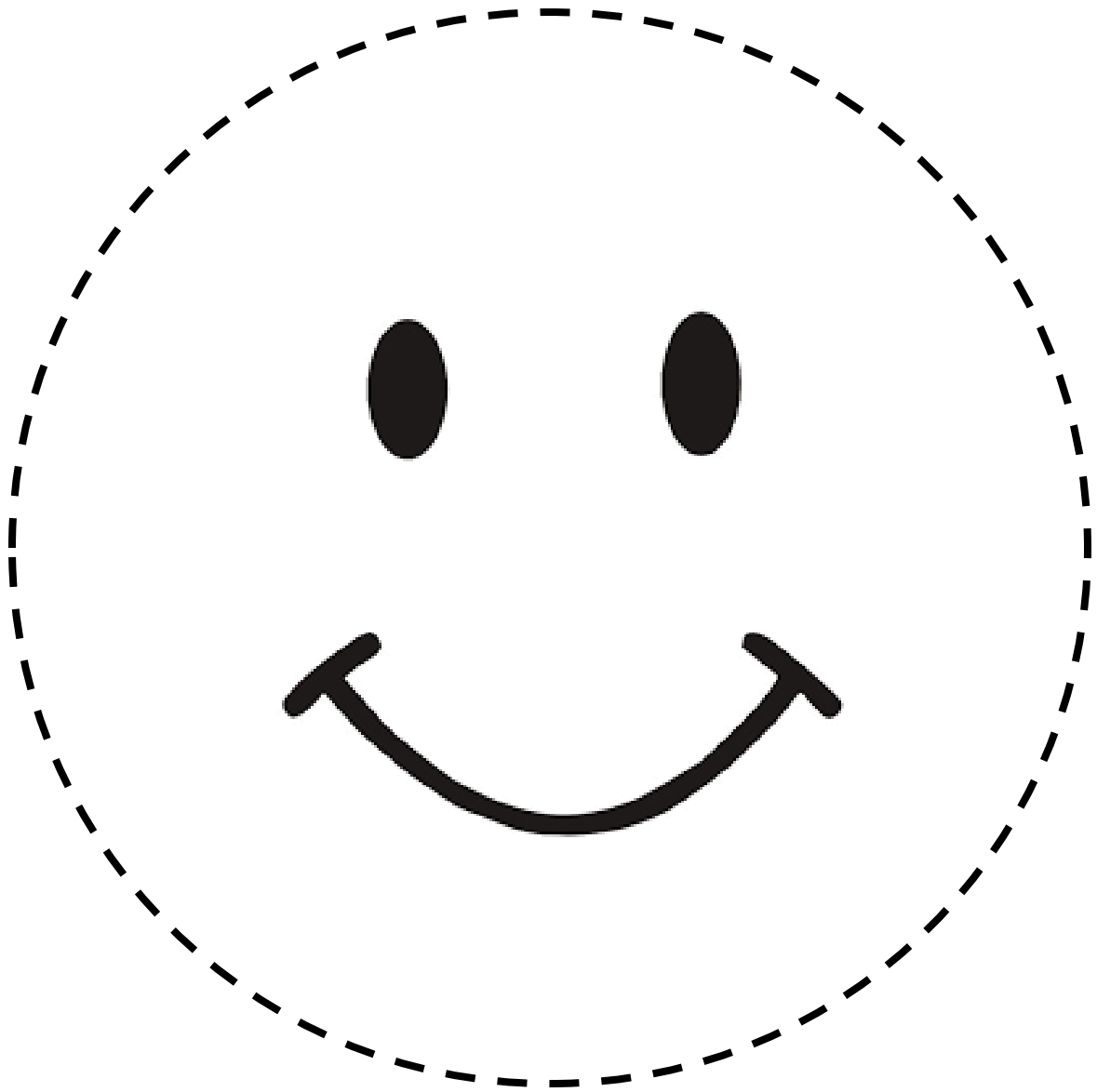

Kom ons oefen
die sirkel

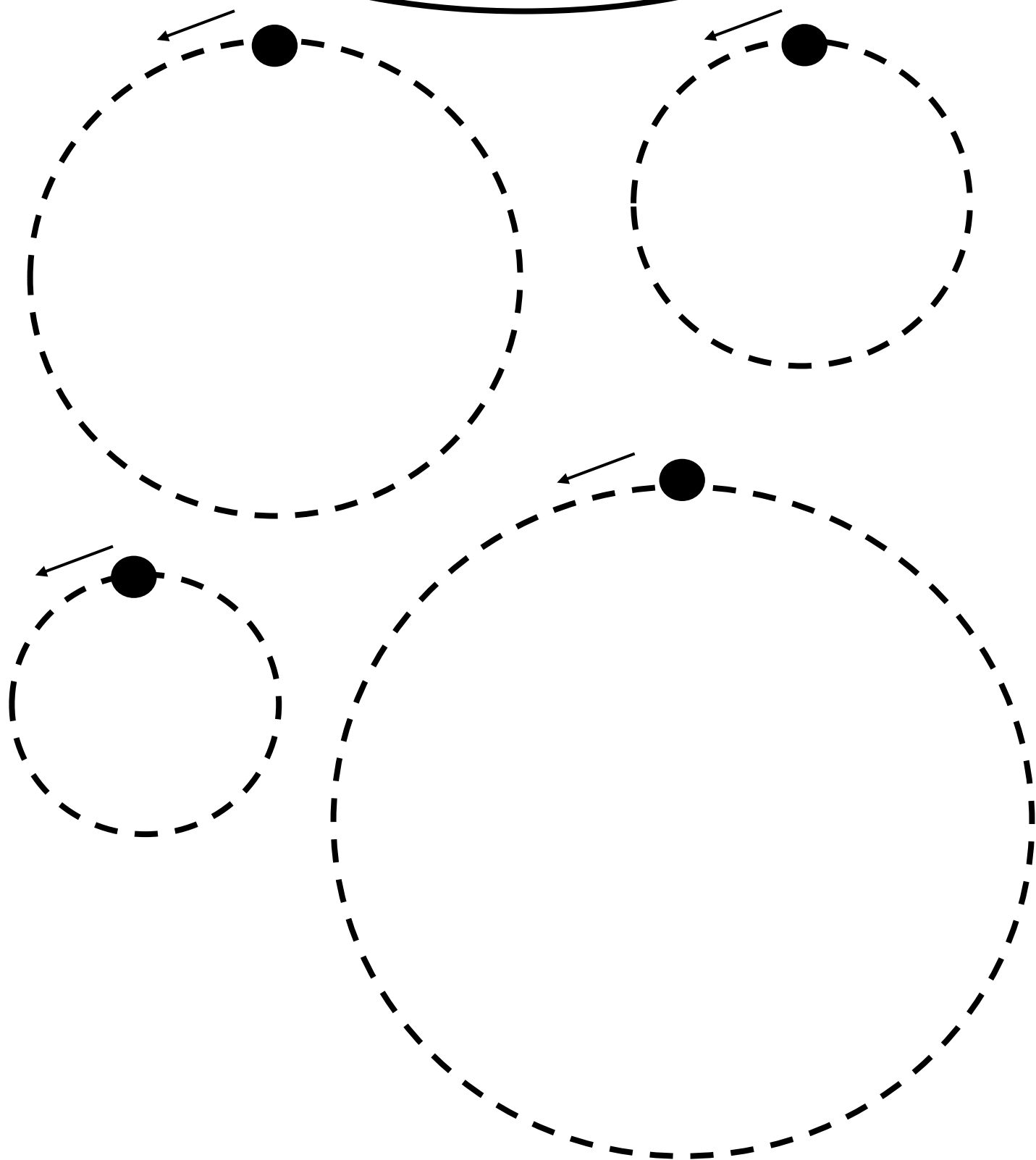
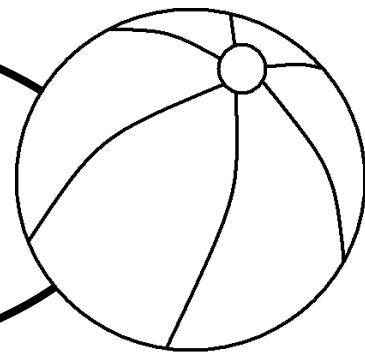

Die bytjie is baie
liefdevol. Oefen om vir
hom harte te teken

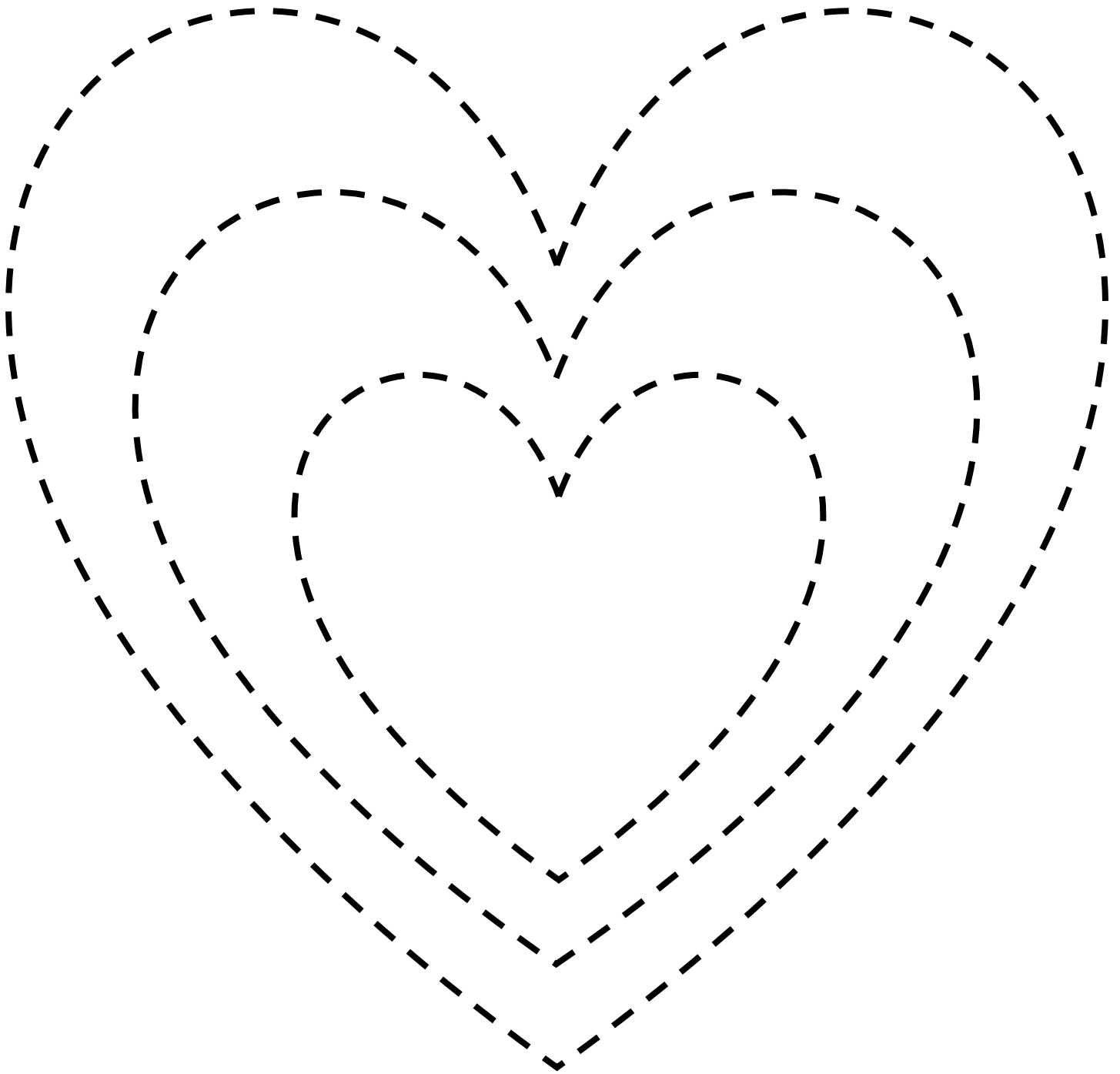
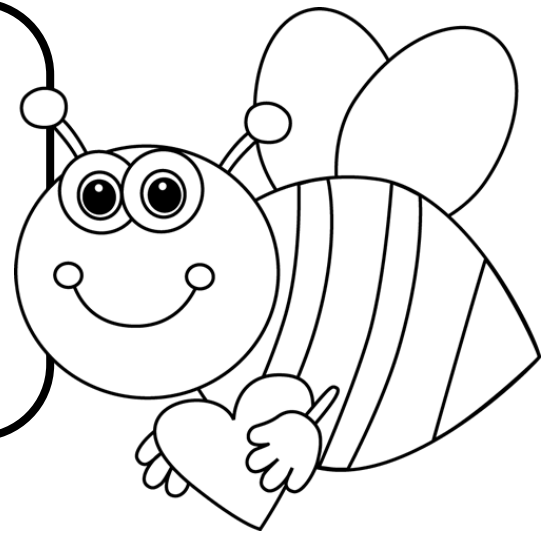

Voltooi die robot se
patrone

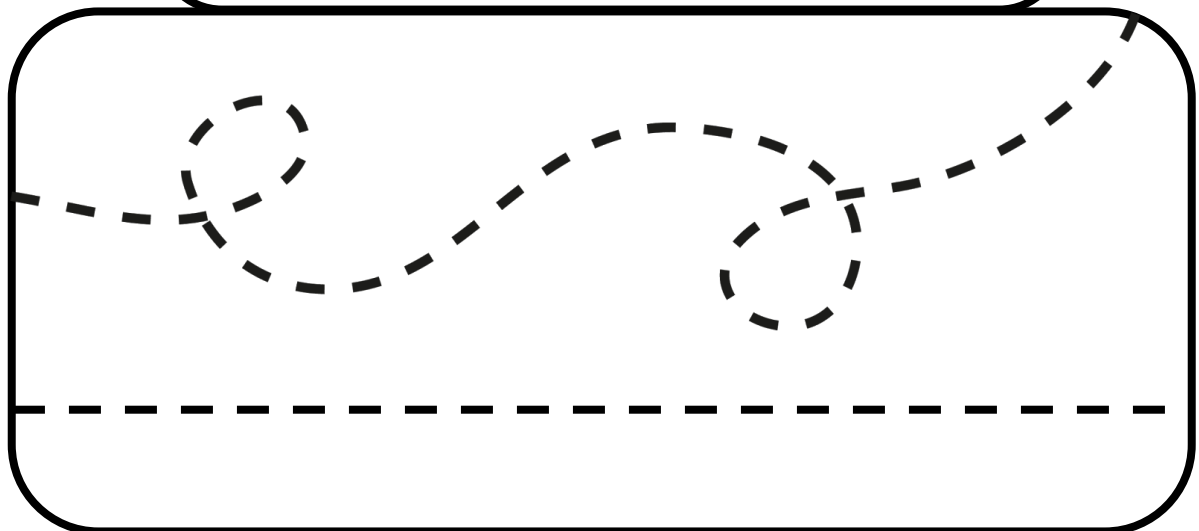
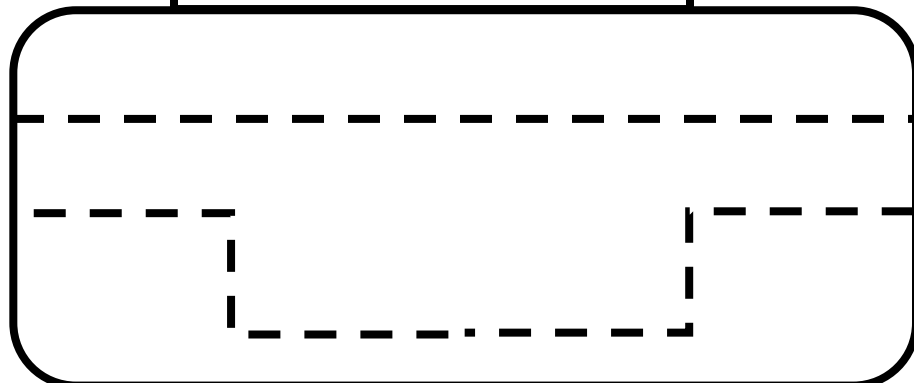
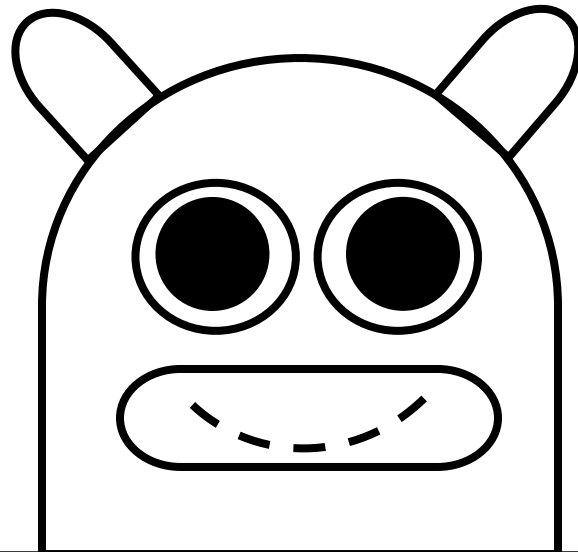

Kom ons oefen die
vierkant

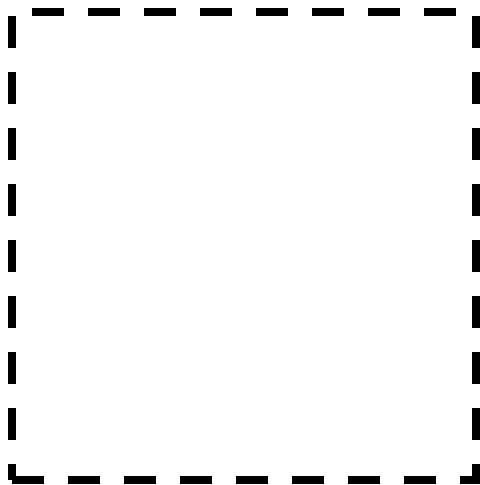
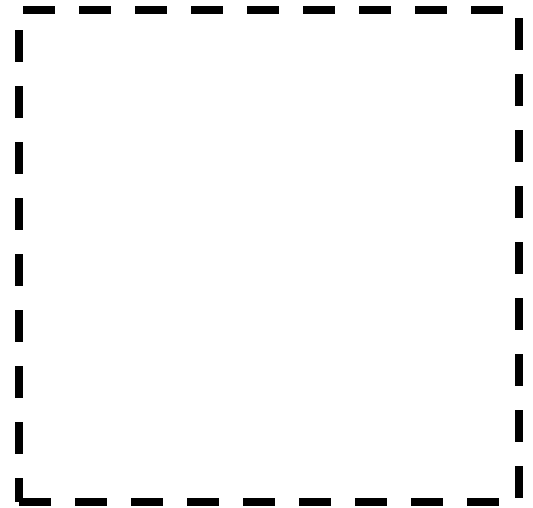
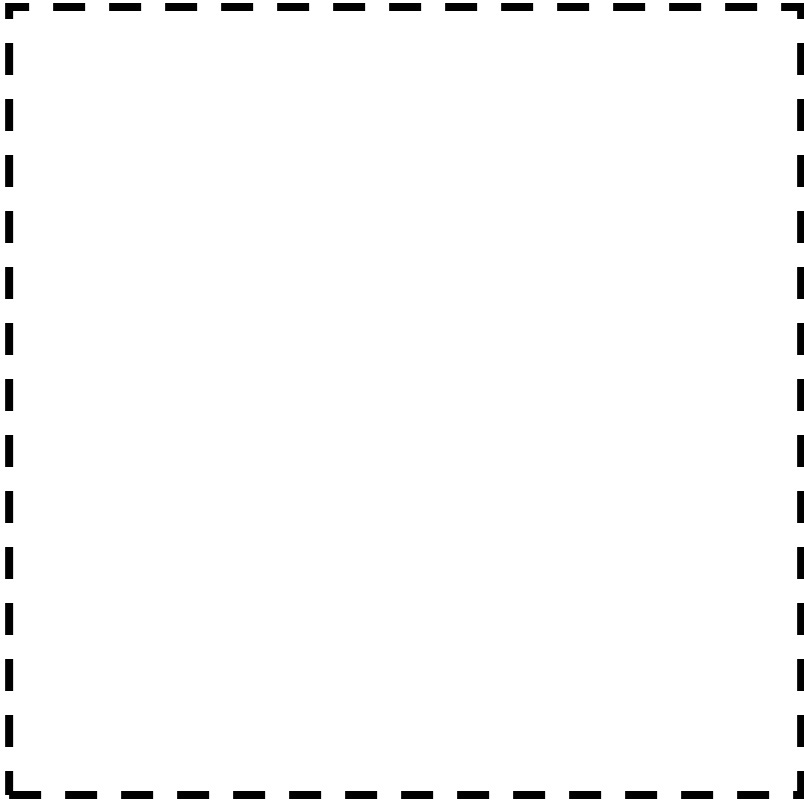
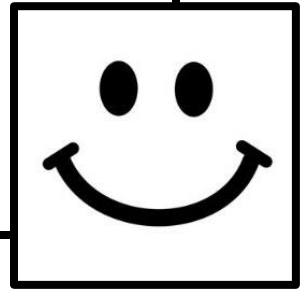

Voltooi die stippellyn
prent

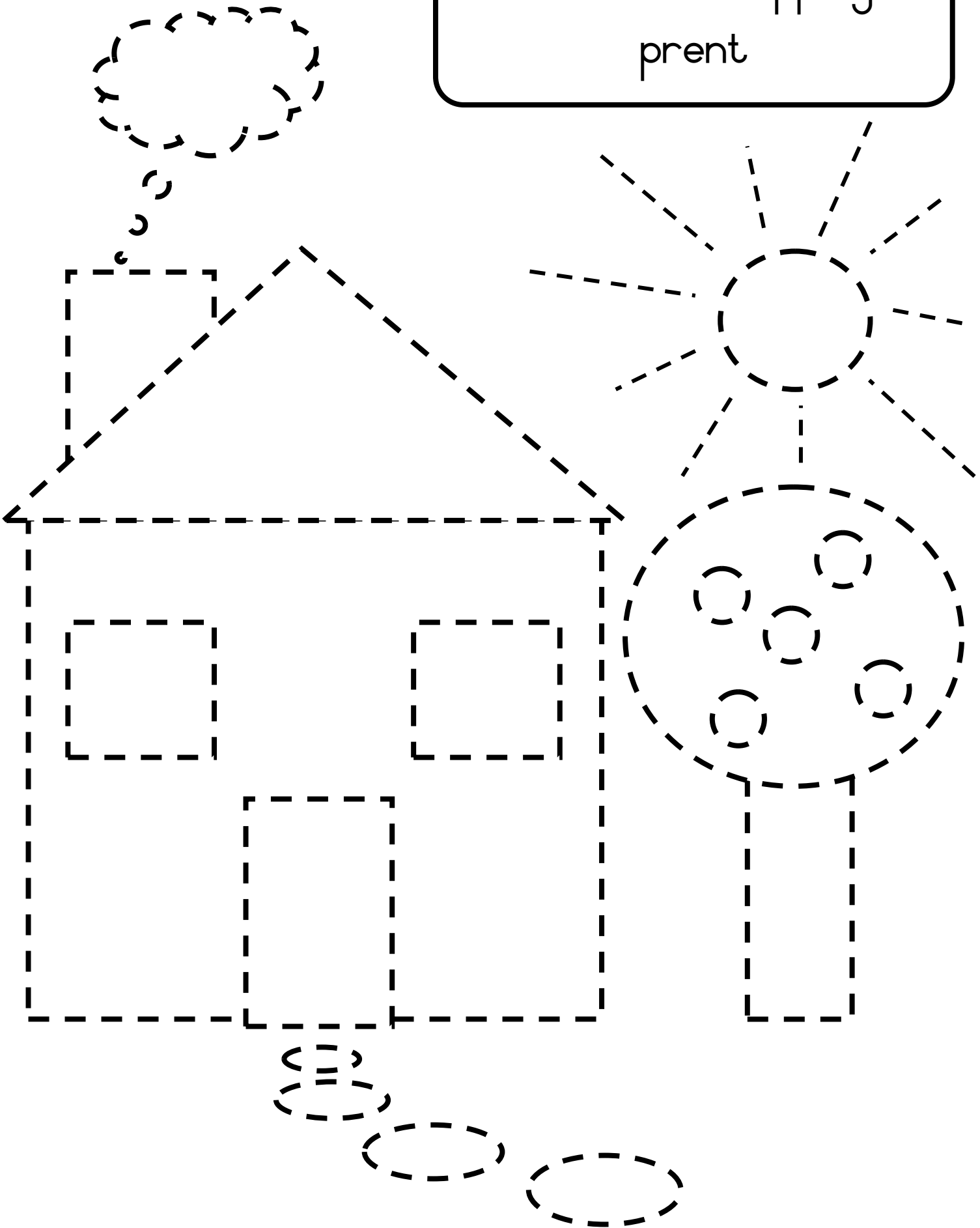

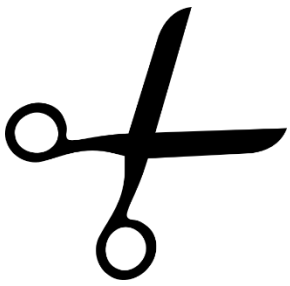

Kleur die vorms in, knip dit uit en plak dit op hul maat op die volgende bladsy

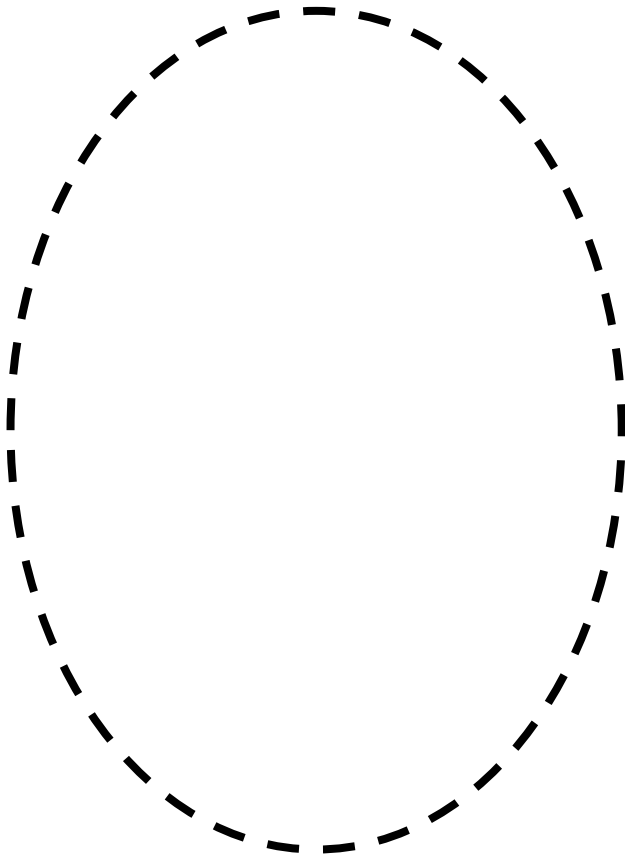
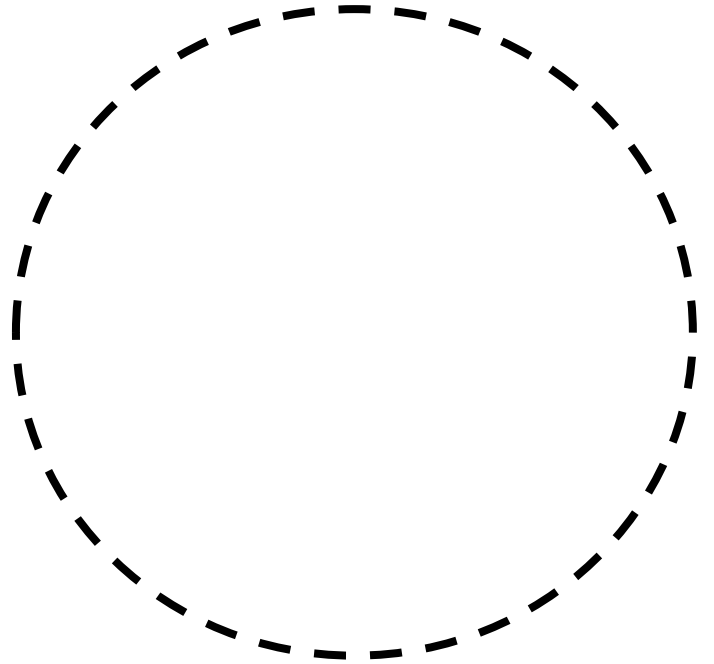
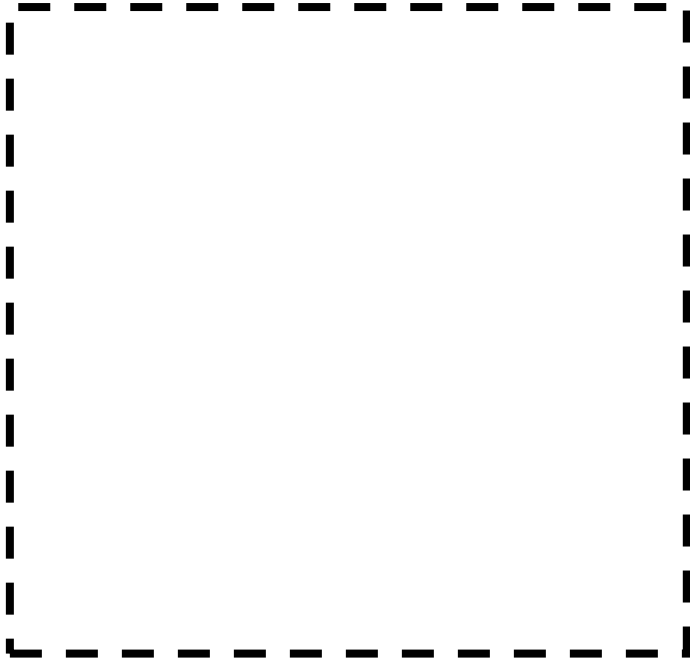

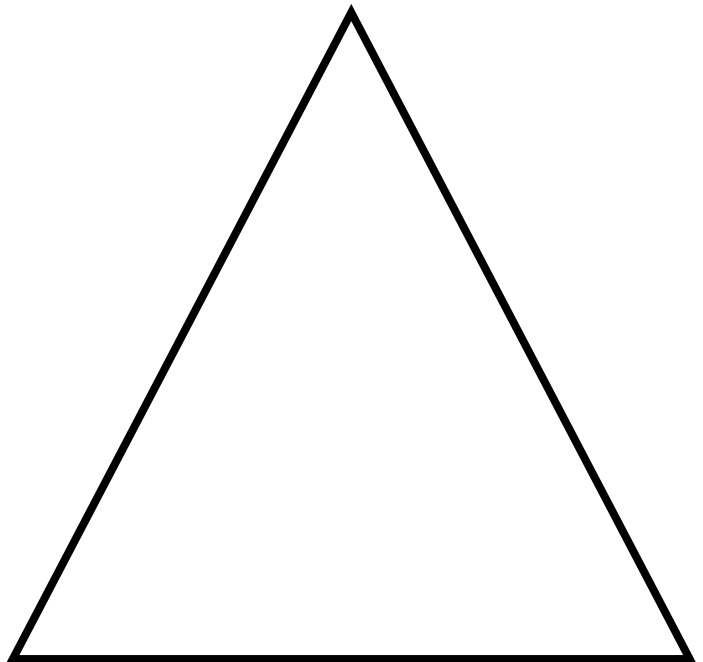
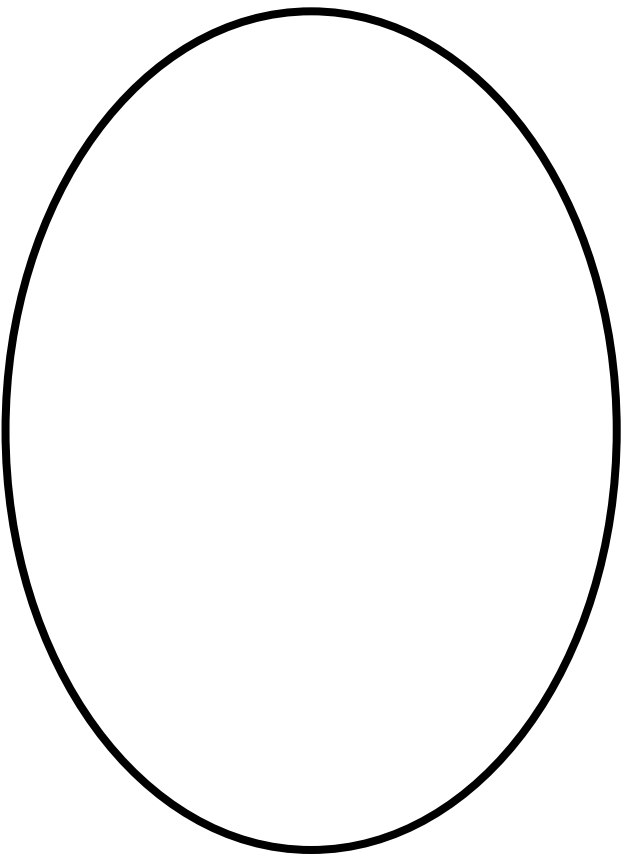
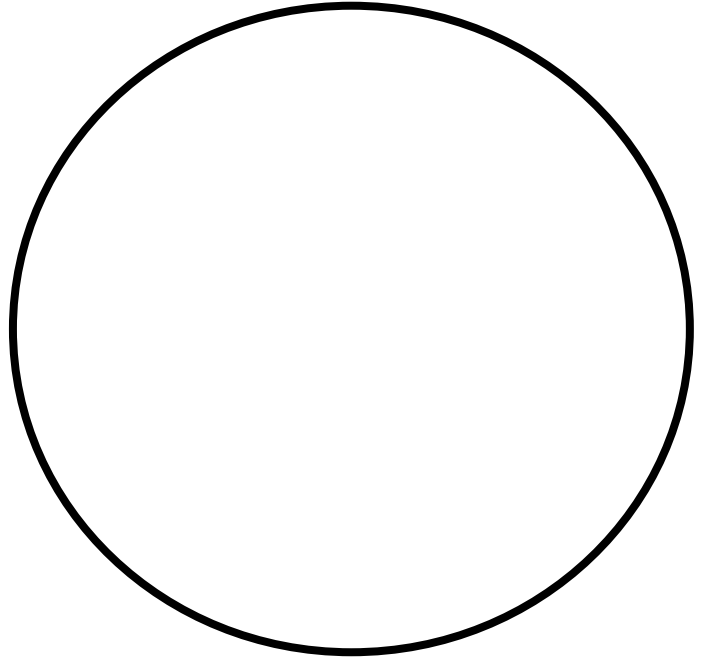
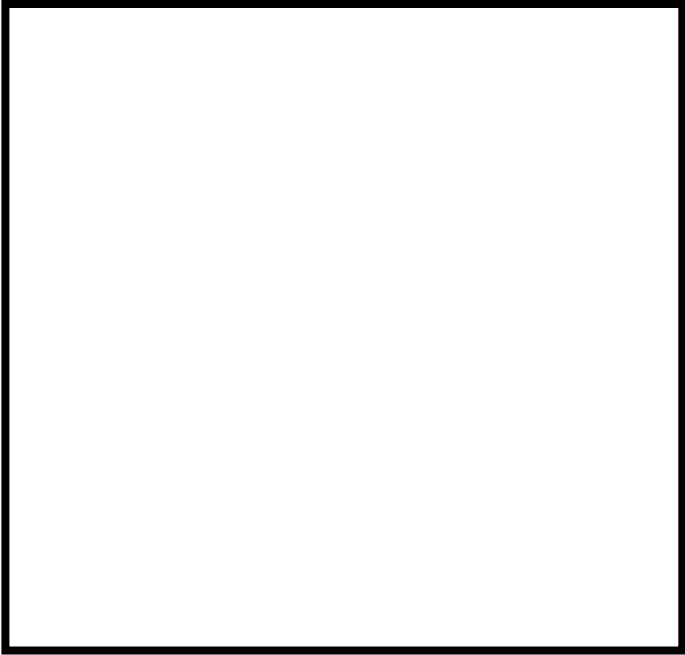

Knip rooi prente uit 'n tydskrif en
plak dit

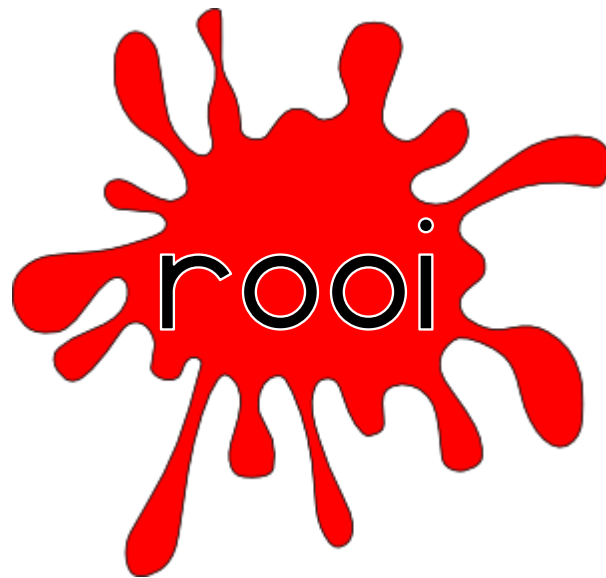

Knip blou prente uit 'n tydskrif en
plak dit

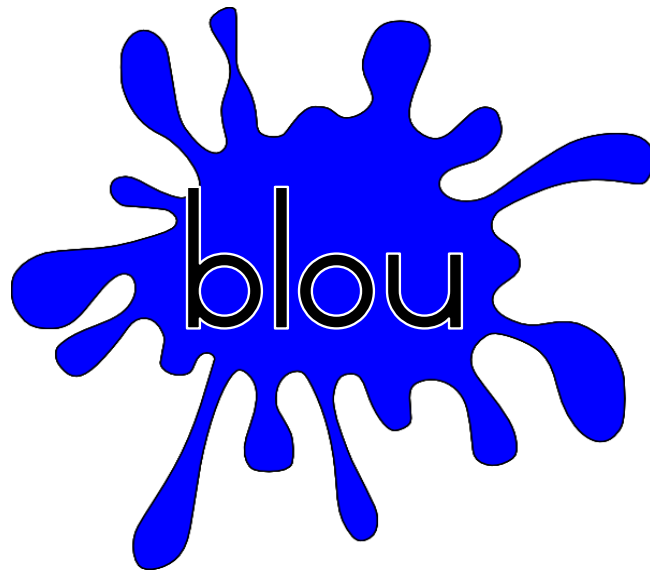

Knip pers prente uit 'n tydskrif en
plak dit

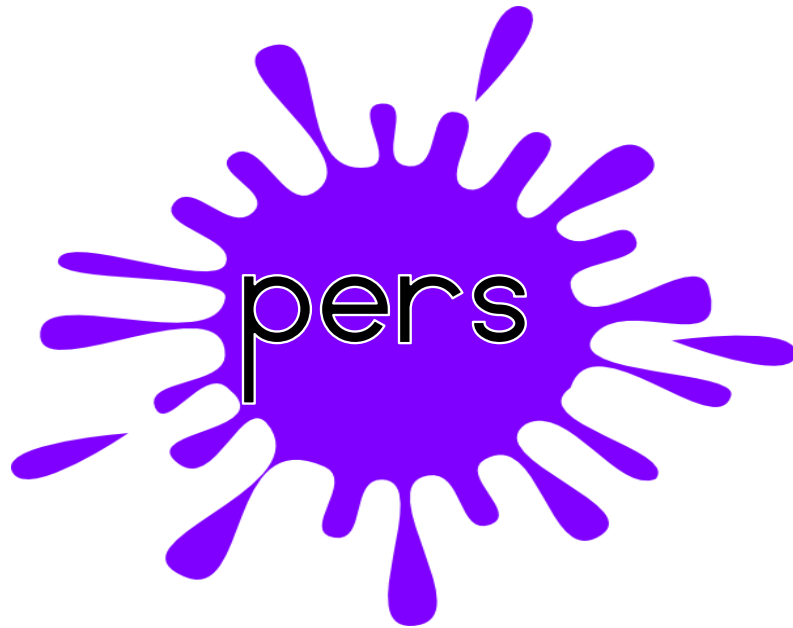

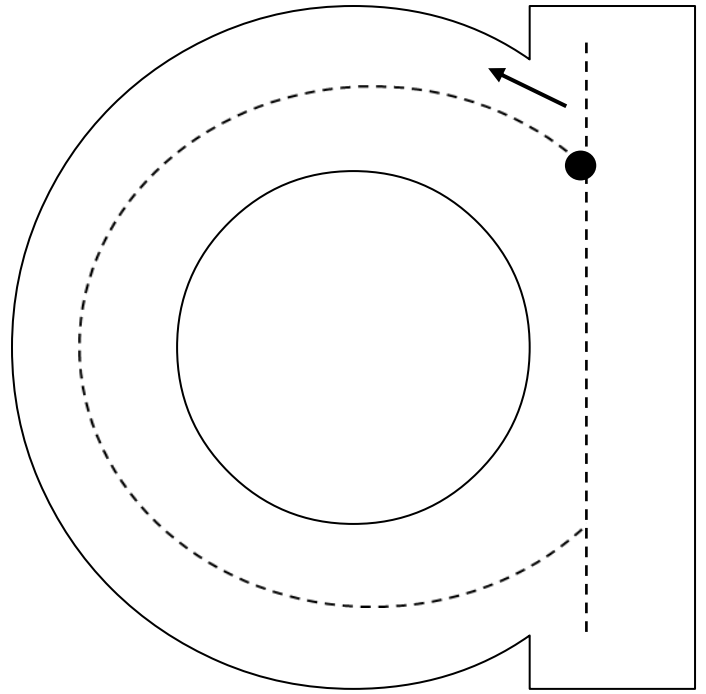
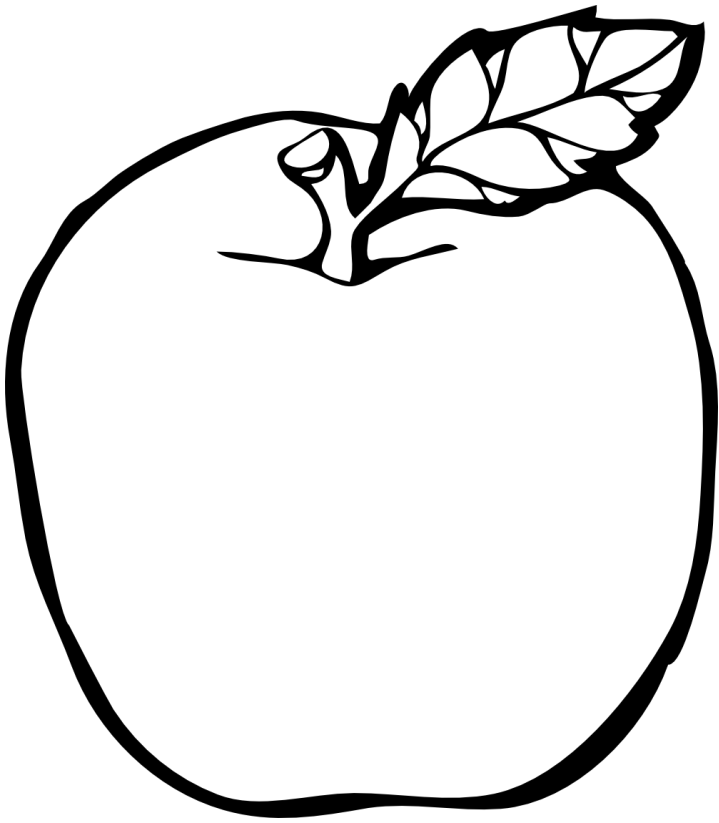

appel

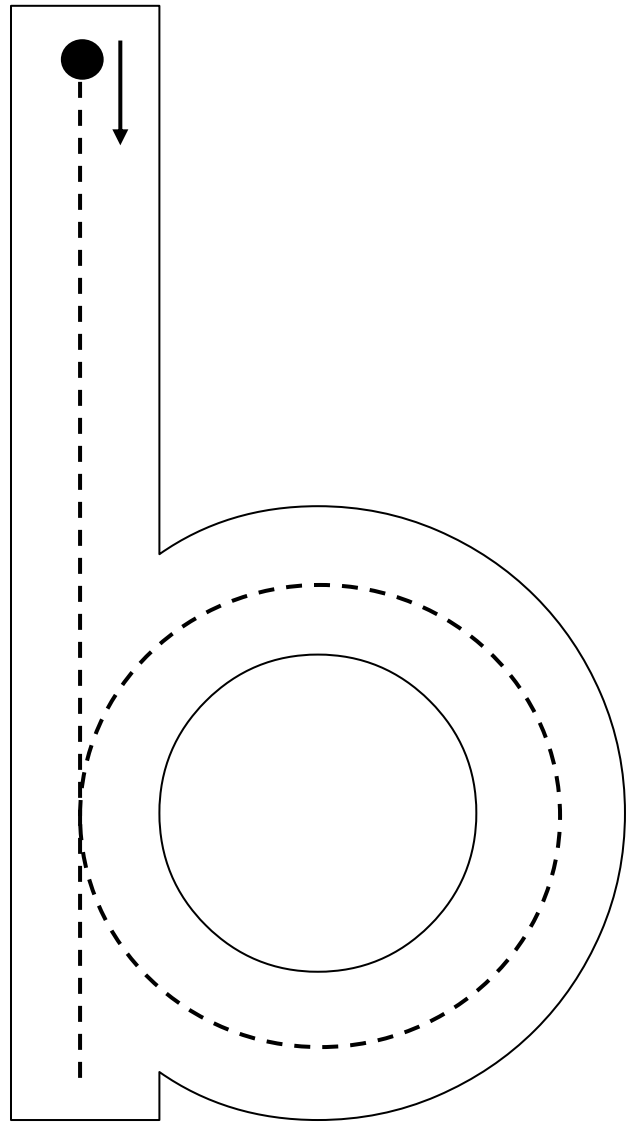

ball

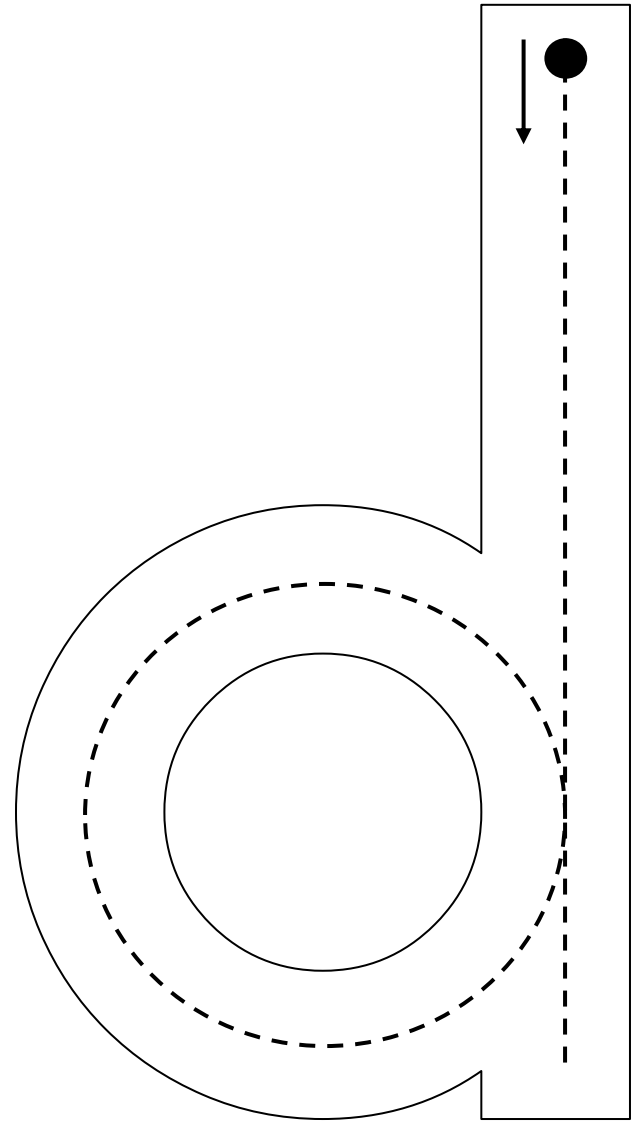
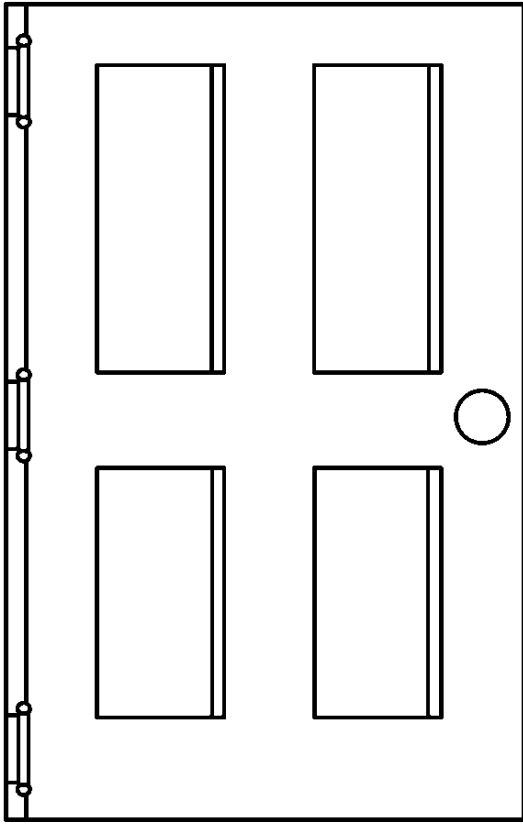

deur

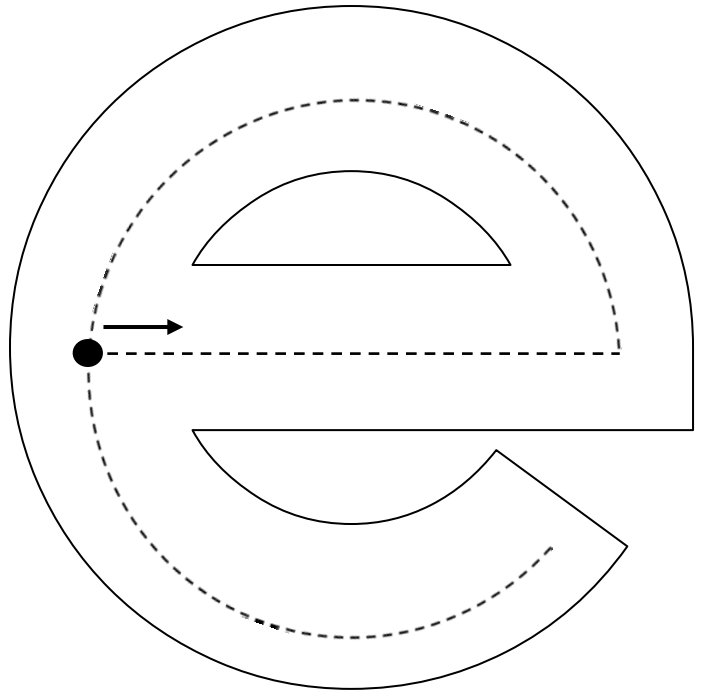
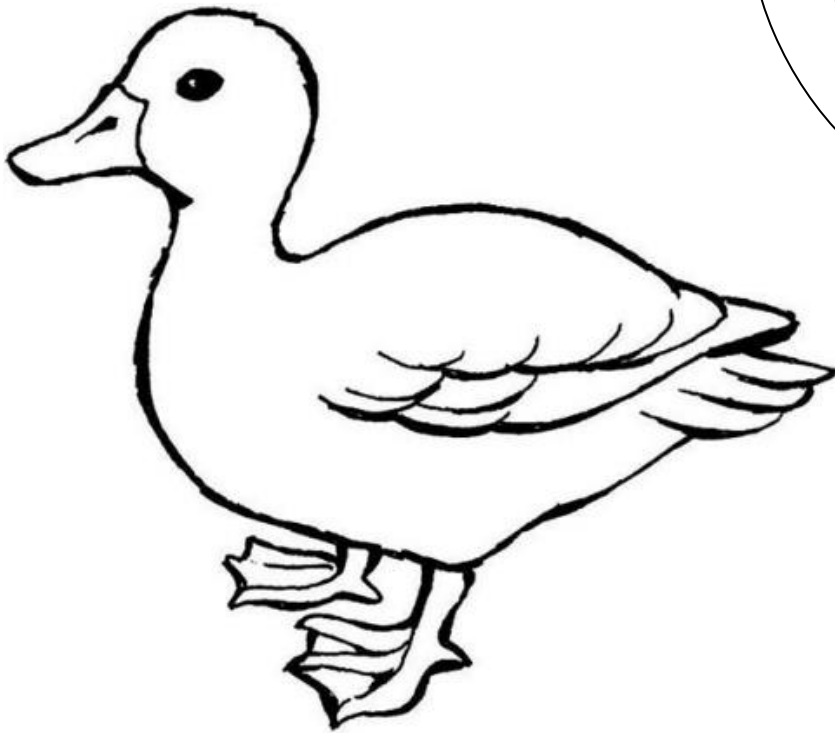

e e n d

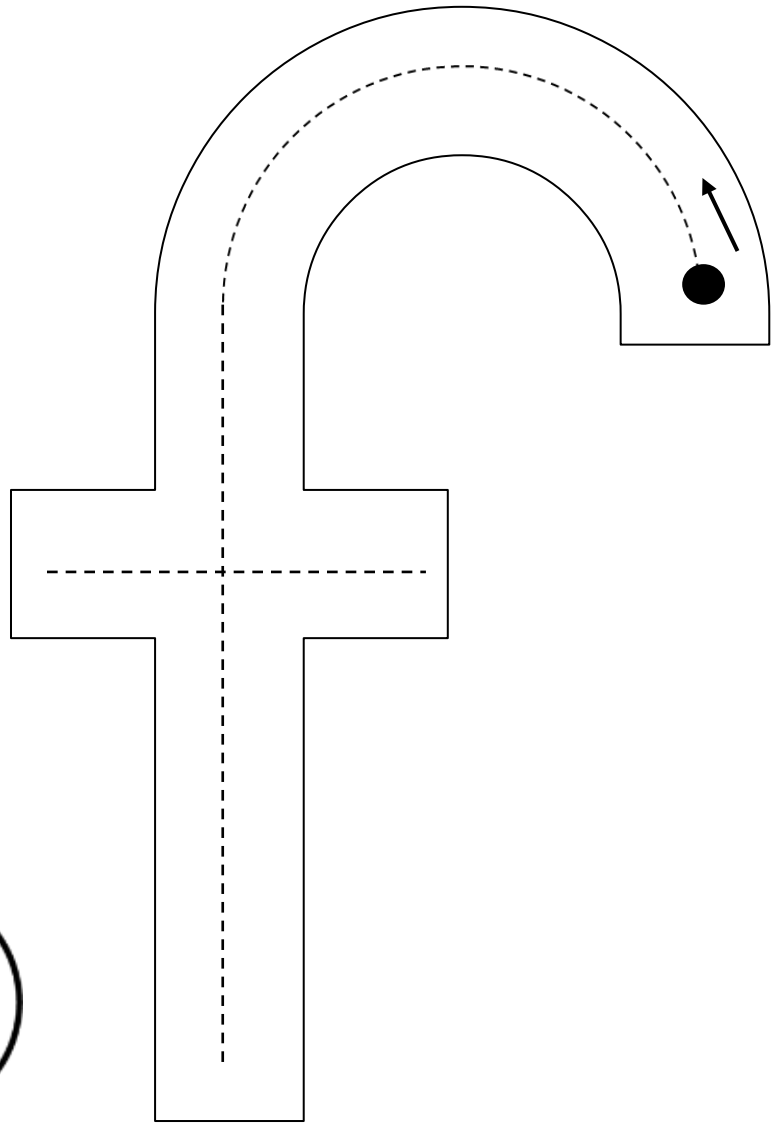

fiet s

Hoeveel appels is daar?

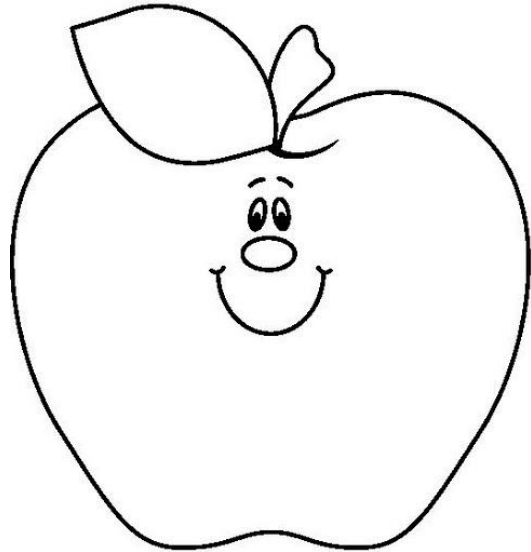
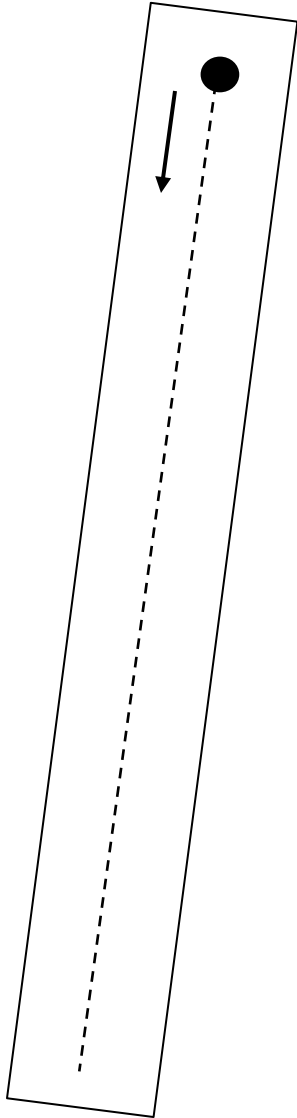

Handwriting practice area with two sets of lines. The first set contains the word "een" (one) in dotted letters for tracing. The second set contains five vertical dashed lines for tracing.

Hoeveel appels is daar?

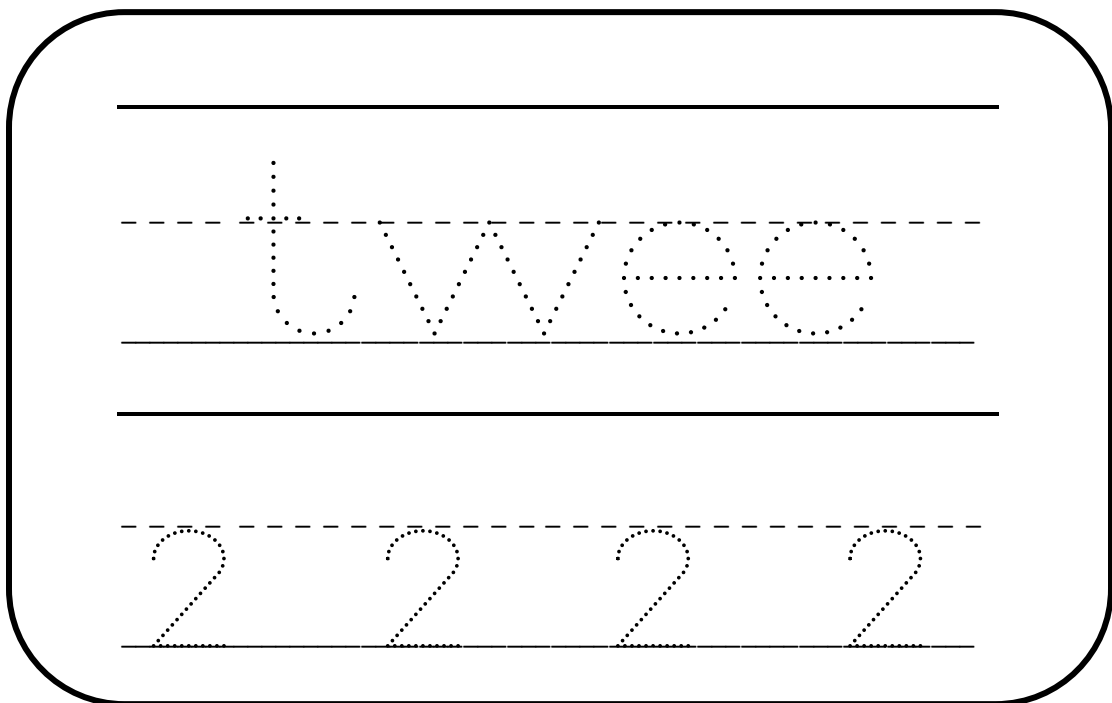
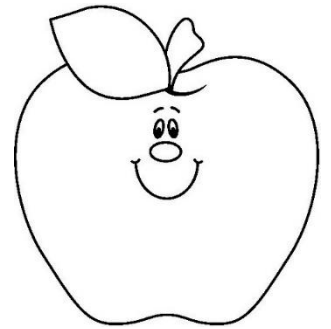
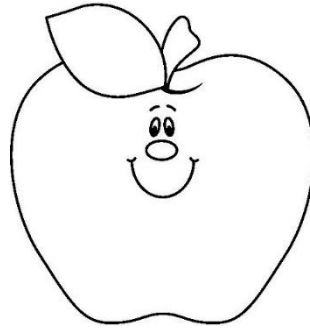
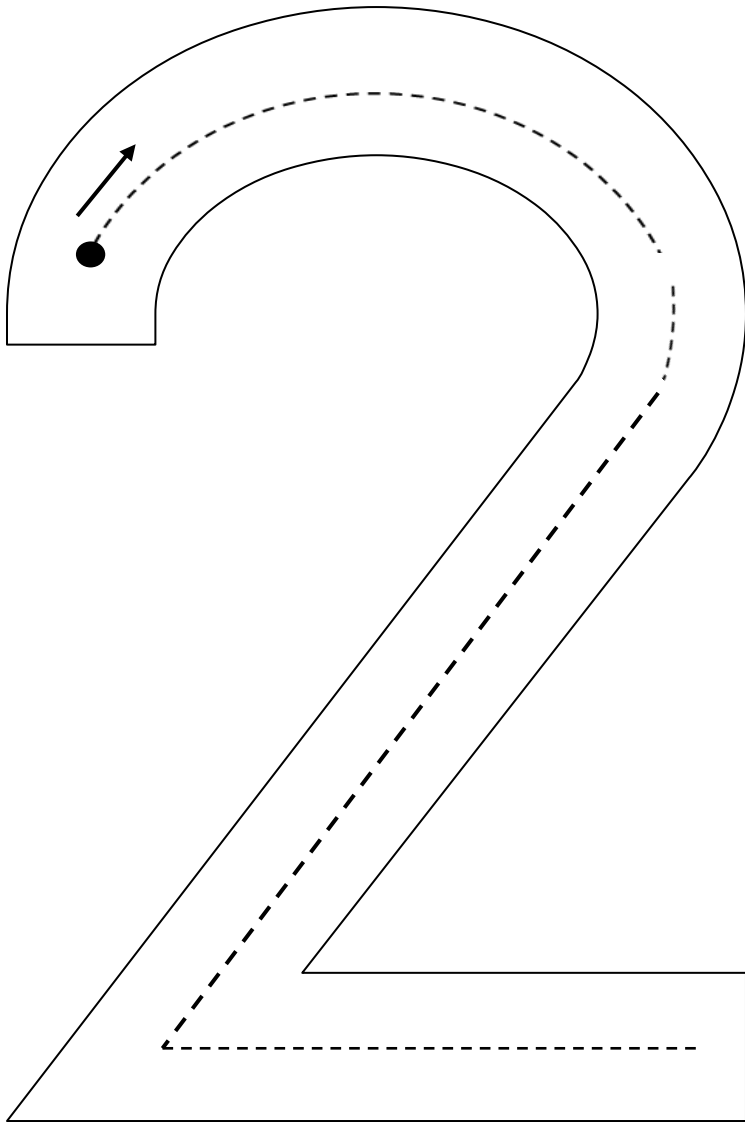

Hoeveel appels is daar?

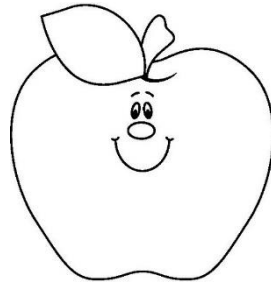
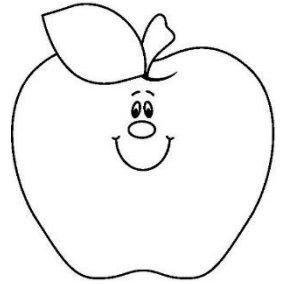
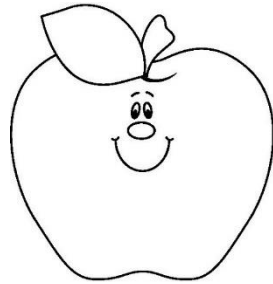
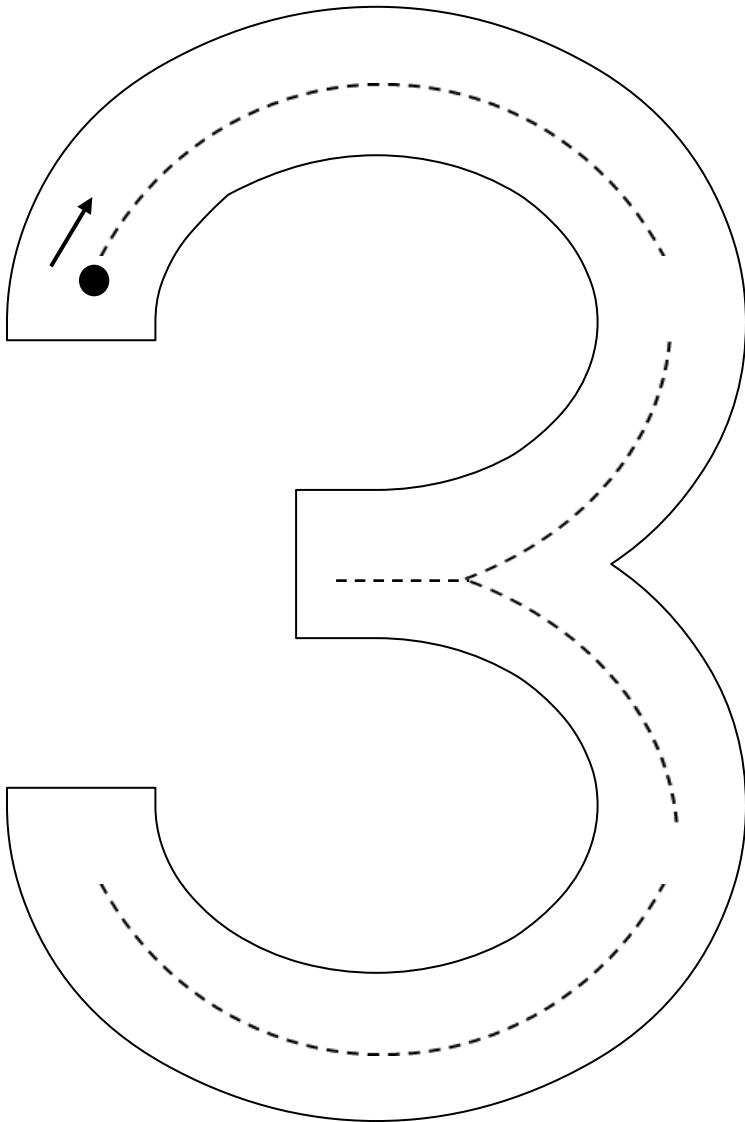

Handwriting practice area with rounded corners, containing three rows of lines:

- Top row: A dotted outline of the Dutch word "drie" (three) for tracing, positioned between a solid top line and a solid bottom line, with a dashed middle line.
- Middle row: A solid top line and a solid bottom line, with a dashed middle line, providing a blank space for independent writing.
- Bottom row: Four dotted outlines of the number "3" for tracing, positioned between a solid top line and a solid bottom line, with a dashed middle line.

Hoeveel appels is daar?

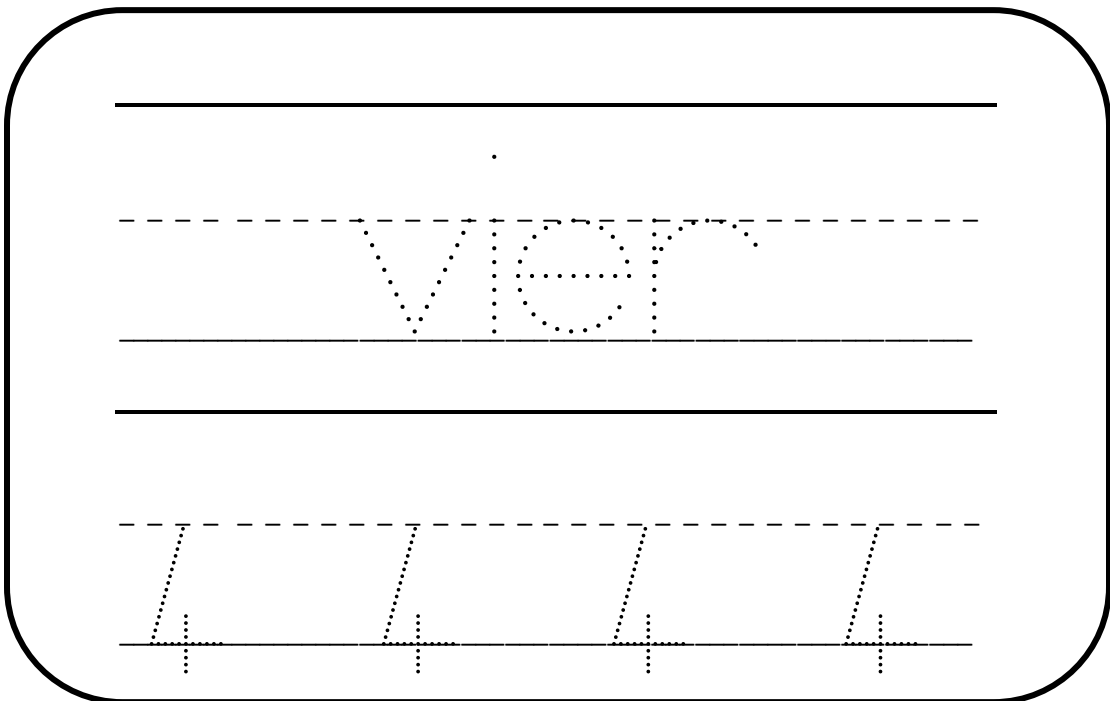
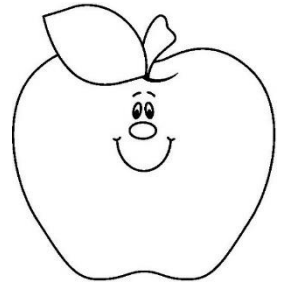
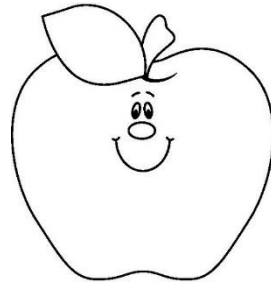
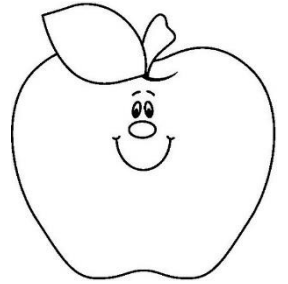
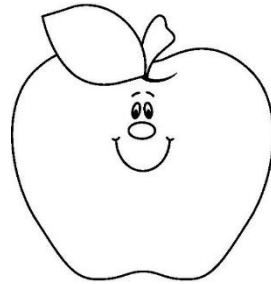
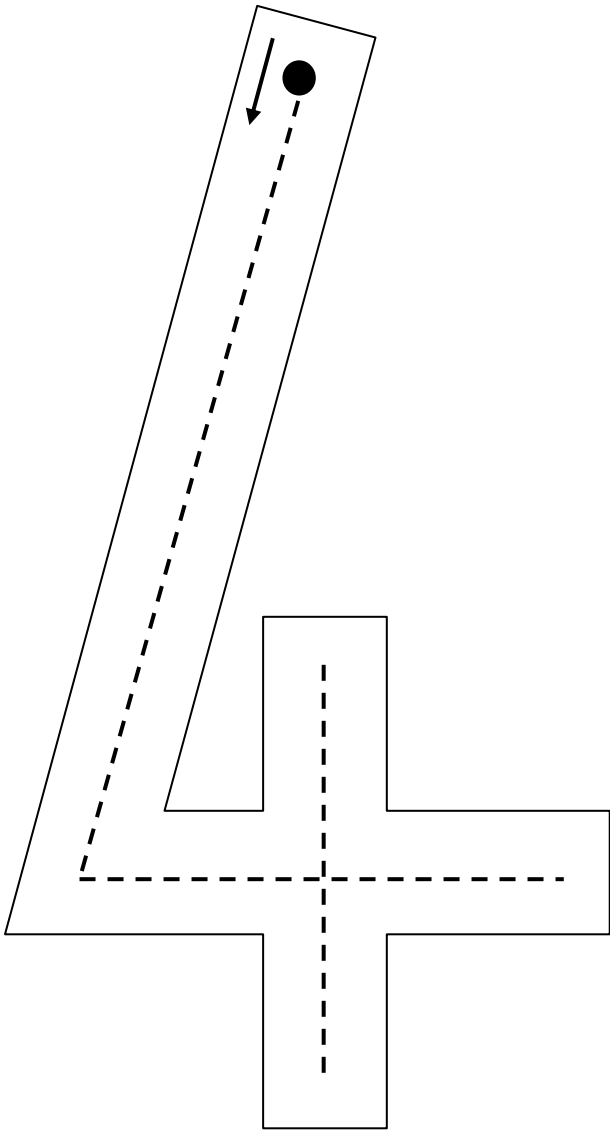

Hoeveel appels is daar?

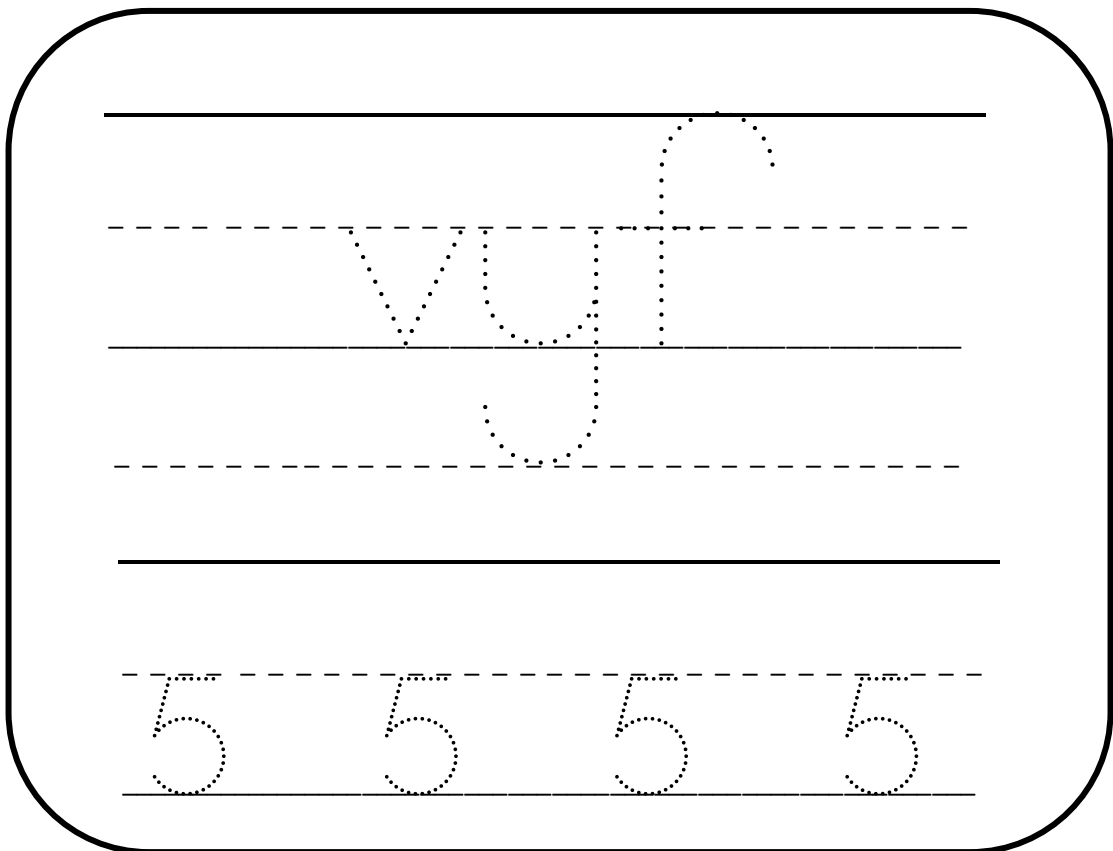
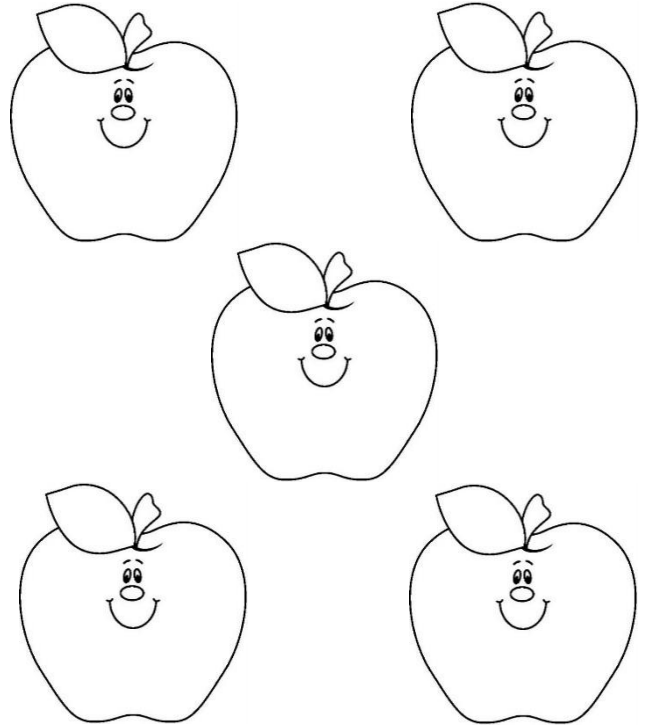
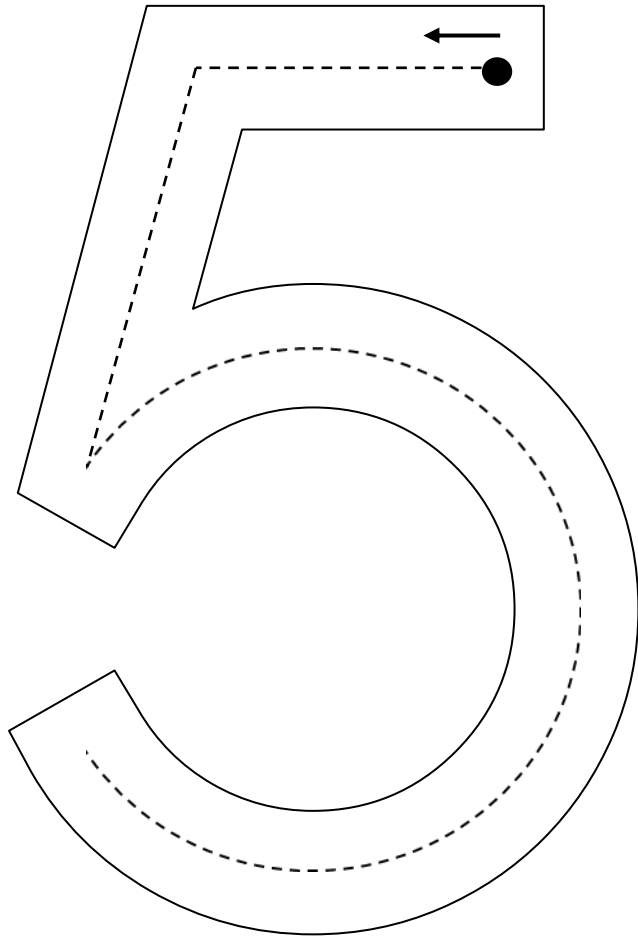

Ek ken my kleure!

Kleur die prent die regte kleur in
en oefen die woord

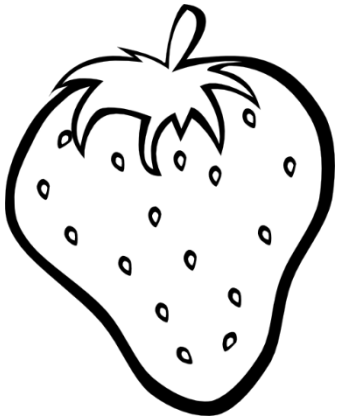

rooi

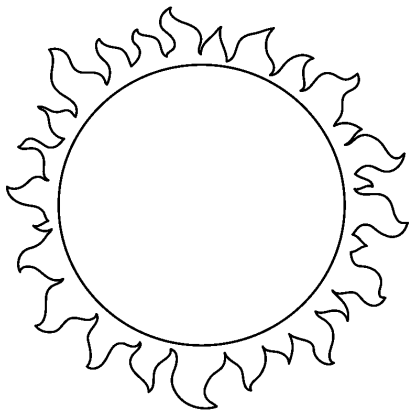

geel

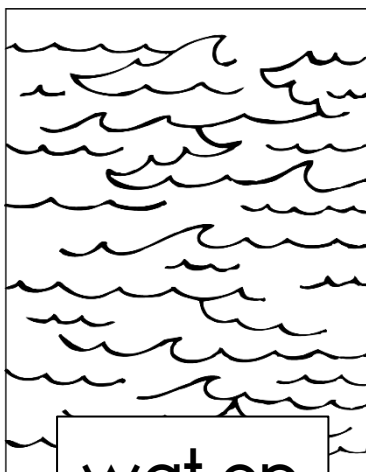

water

blou

Die blaar is

groen

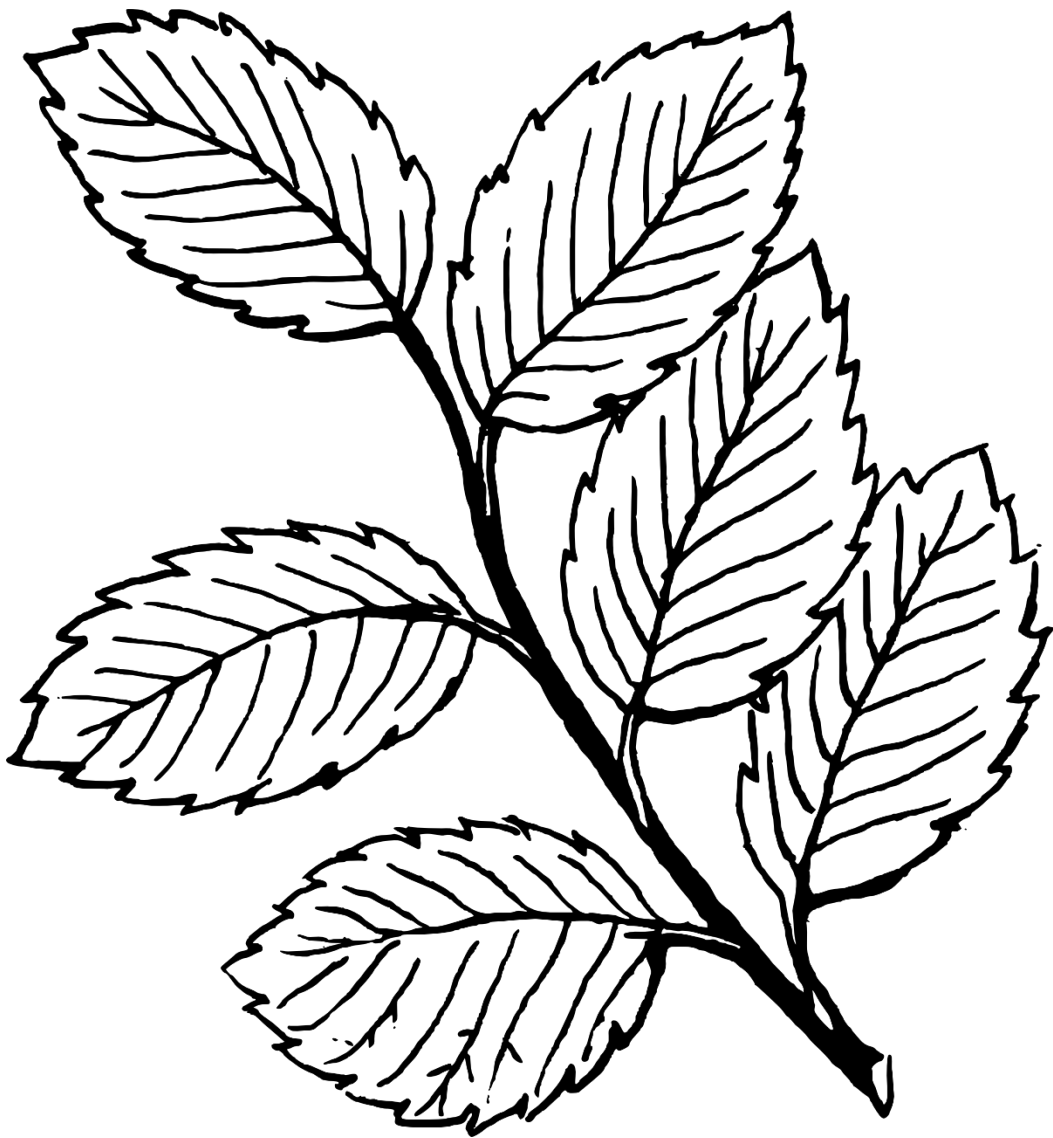

Die lemoen

is oranje

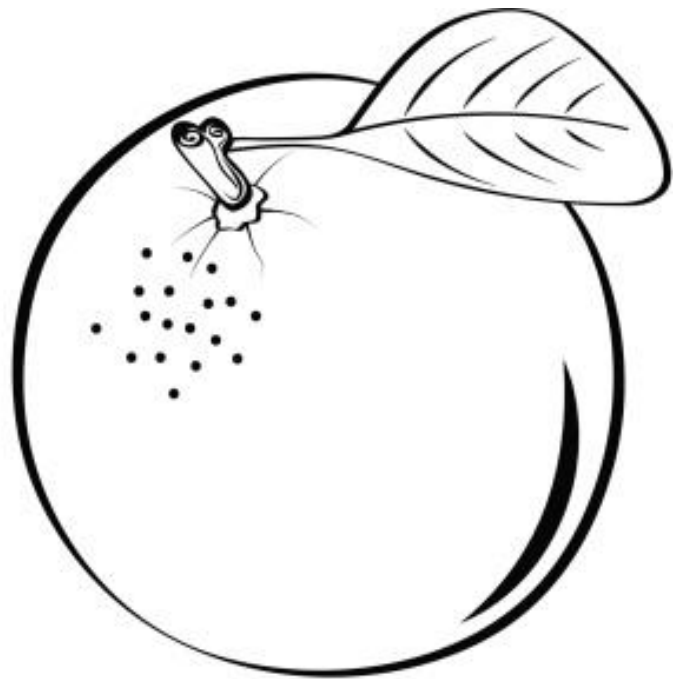
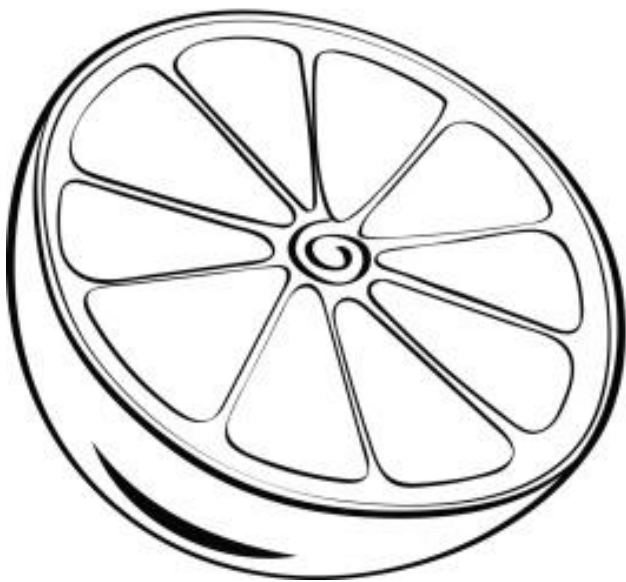

A decorative border of black circles surrounds the text. The circles are arranged in a rectangular pattern, with 7 circles in each of the top and bottom rows, and 10 circles in each of the left and right columns.





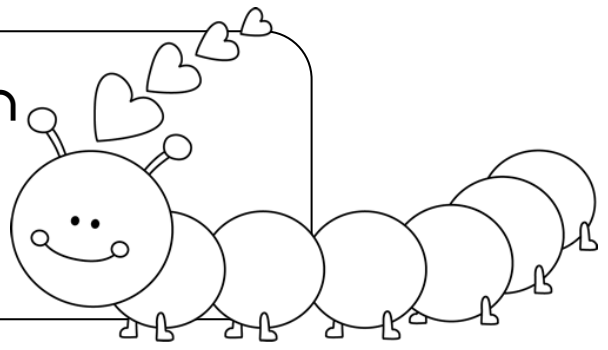

VINGERVERF

Die volgende aktiwiteite is
vingerverf.

Die leerder moet die punt
van hul vinger in die verf
druk en dan die oefeninge
doen

Maak vir die wurmpie 'n
lyfie



4		
1		
3		
5		
2		
6		

Gee vir die blomme
blaartjies.

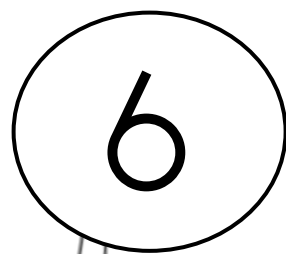
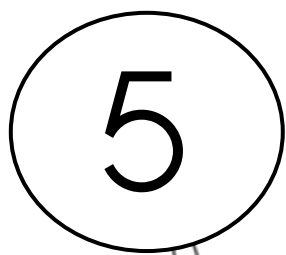
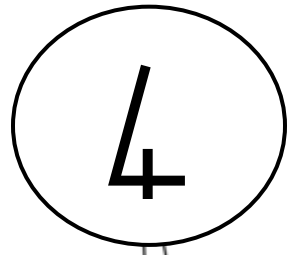

Druk met jou vinger in elke
sirkel om die letter te vorm

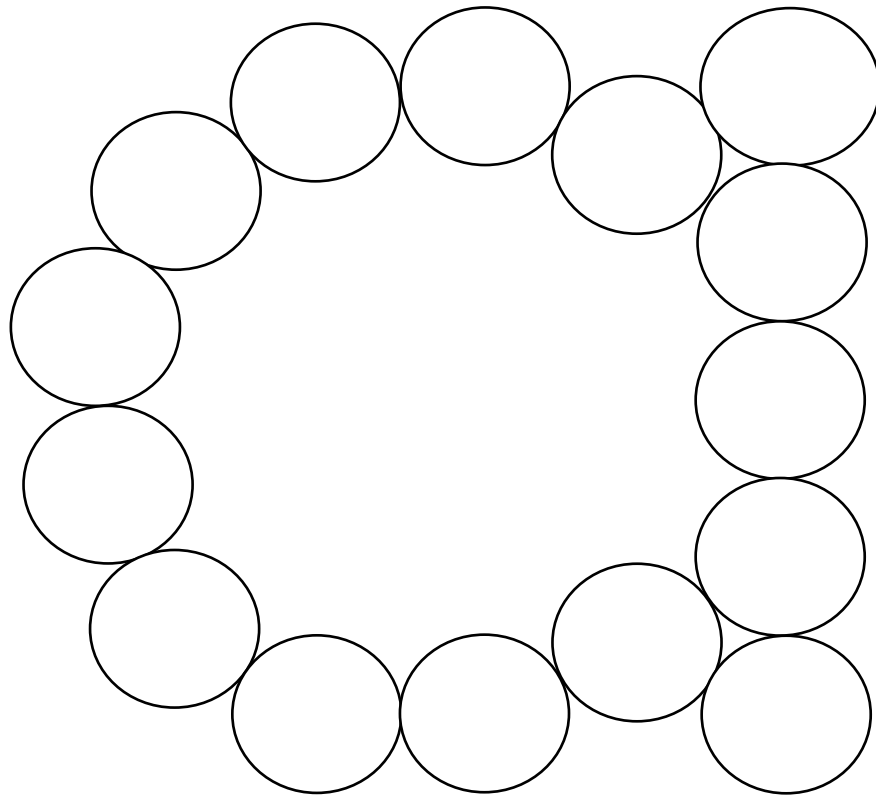

a vir

appel

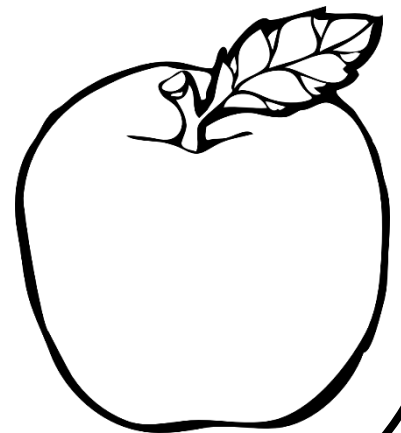

Druk met jou vinger in elke
sirkel om die letter te vorm

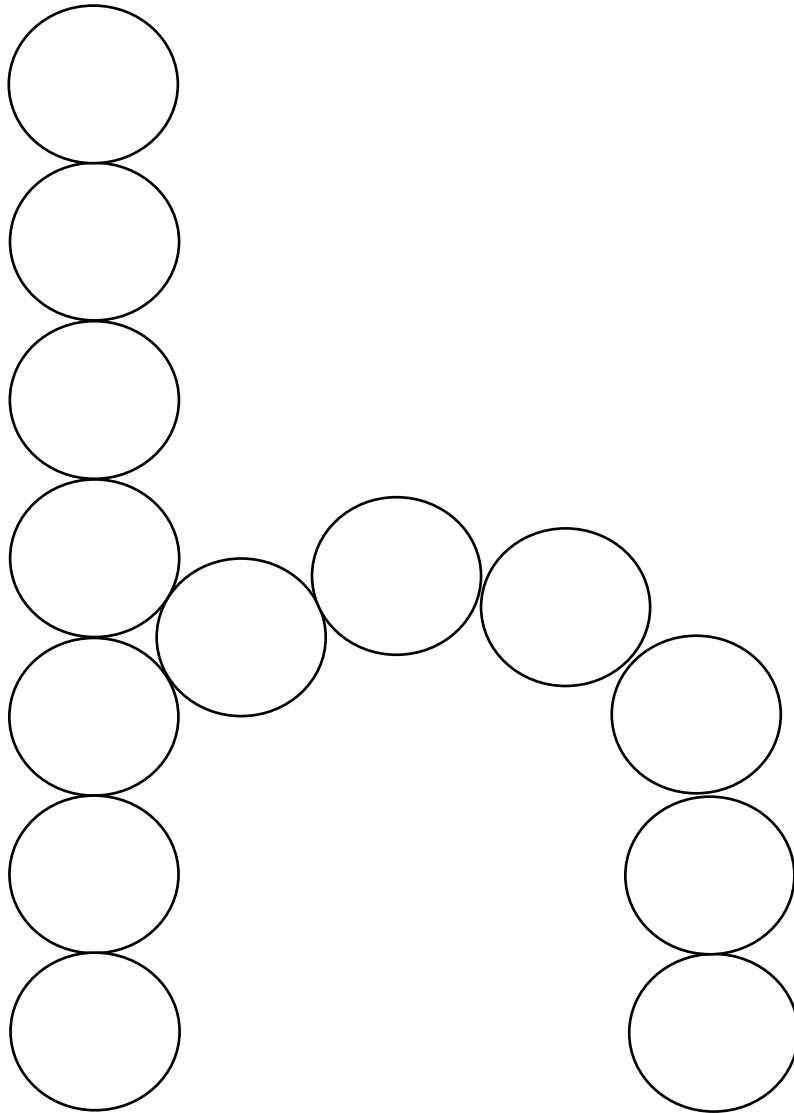

h vir

hads



Druk met jou vinger in elke
sirkel om die letter te vorm

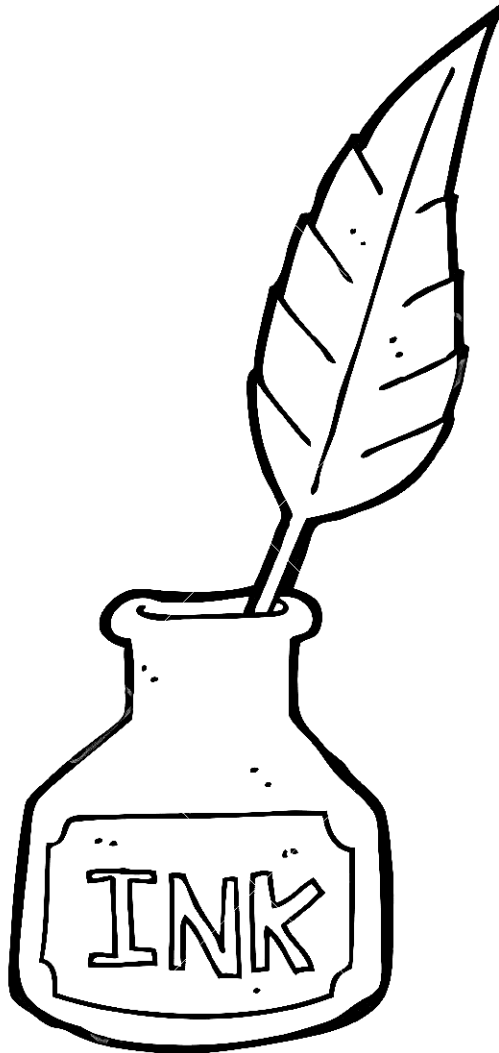
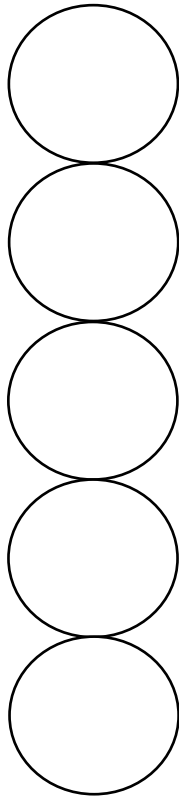
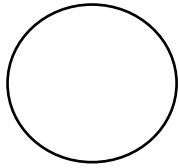

i vir

ink

Druk met jou vinger in elke
sirkel om die letter te vorm

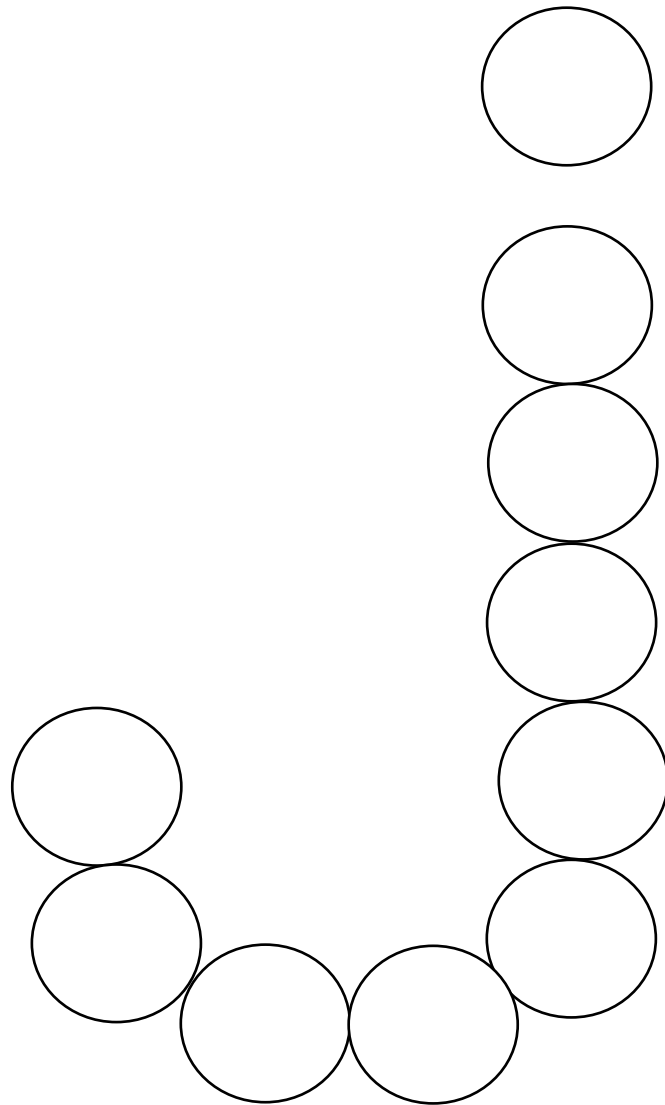

j vir

jas

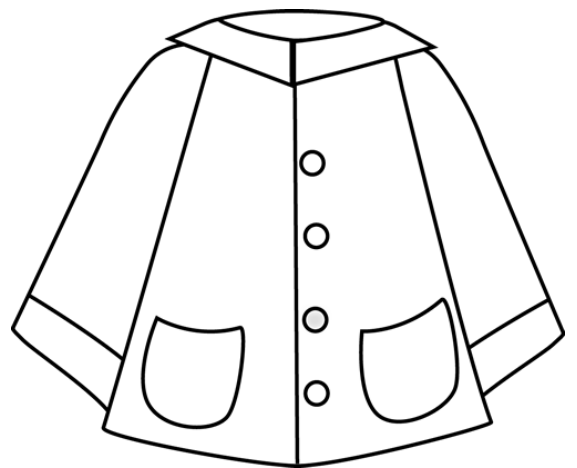

Druk met jou vinger in elke
sirkel om die letter te vorm

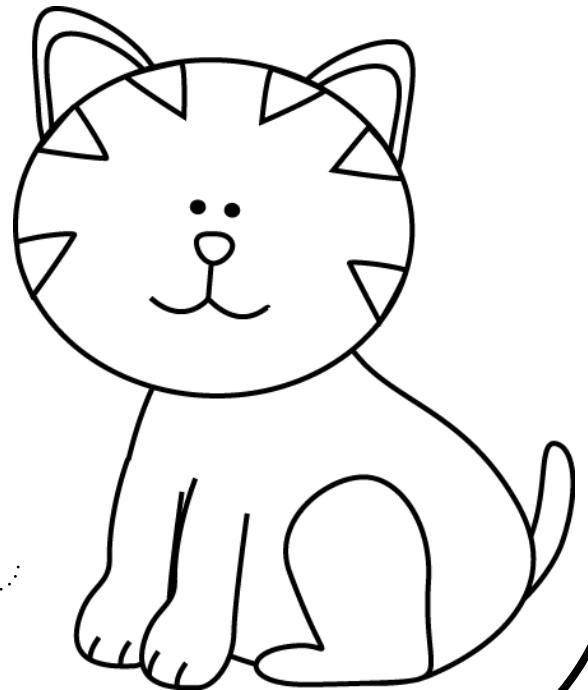
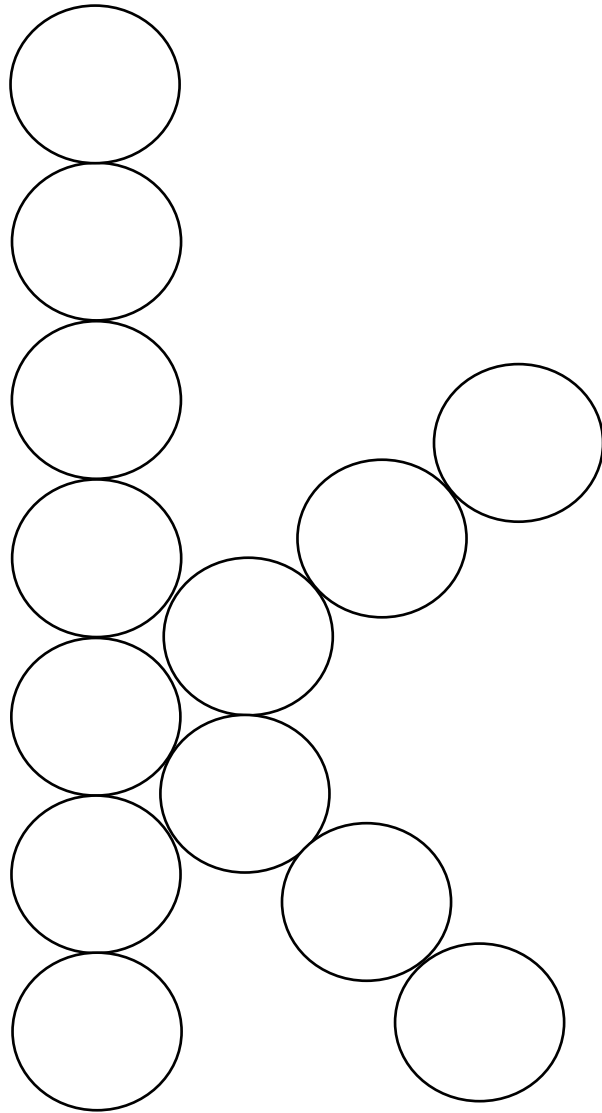

k

vir

kat

Druk met jou vinger in elke
sirkel om die letter te vorm

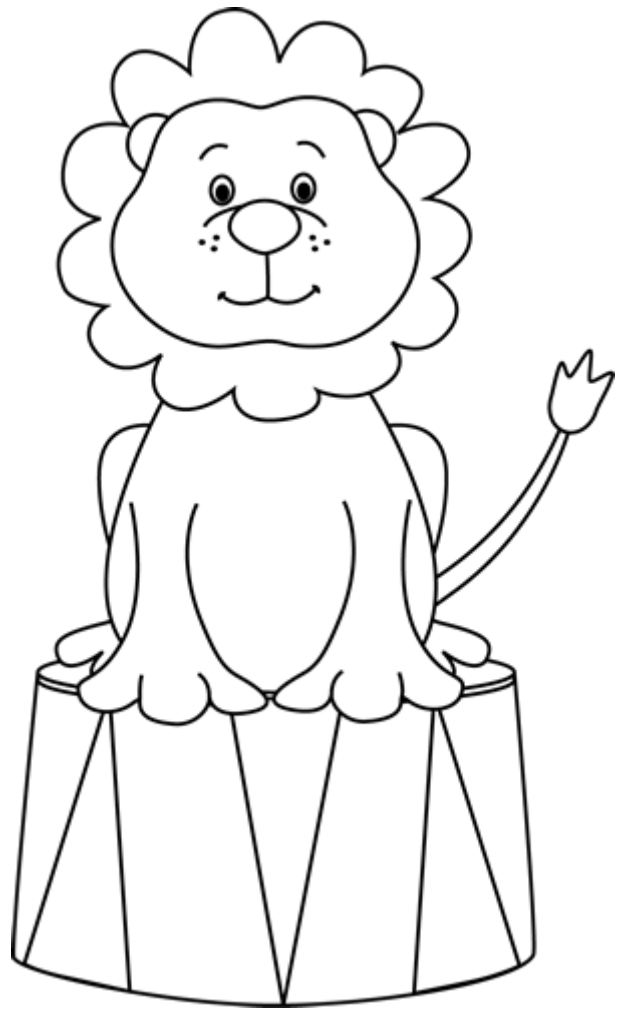
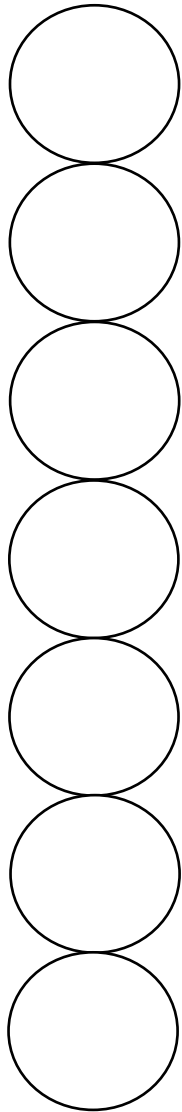

I vir

leu